

INVERTER GRADE THYRISTORS

Hockey Puk Version

Features

- Metal case with ceramic insulator
- International standard case TO-200AB (A-PUK)
- All diffused design
- Center amplifying gate
- Guaranteed high dV/dt
- Guaranteed high dI/dt
- High surge current capability
- Low thermal impedance
- High speed performance

Typical Applications

- Inverters
- Choppers
- Induction heating
- All types of force-commutated converters

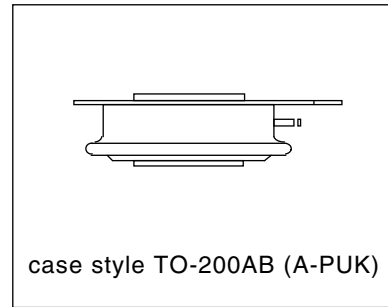
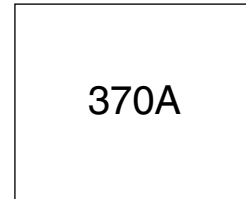

Major Ratings and Characteristics

Parameters	ST183C..C	Units
$I_{T(AV)}$	370	A
@ T_{hs}	55	°C
$I_{T(RMS)}$	690	A
@ T_{hs}	25	°C
I_{TSM}	@ 50Hz 4900	A
	@ 60Hz 5130	A
I^2t	@ 50Hz 120	KA ² s
	@ 60Hz 110	KA ² s
V_{DRM}/V_{RRM}	400 to 800	V
t_q range	10 to 20	μs
T_J	- 40 to 125	°C

ST183C..C Series

Bulletin I25178 rev. B 04/00

International
 TOR Rectifier

ELECTRICAL SPECIFICATIONS

Voltage Ratings

Type number	Voltage Code	V_{DRM}/V_{RRM} , maximum repetitive peak voltage V	V_{RSM} , maximum non-repetitive peak voltage V	I_{DRM}/I_{RRM} max. @ $T_J = T_{J \text{ max.}}$ mA
ST183C..C	04	400	500	40
	08	800	900	

Current Carrying Capability

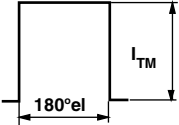
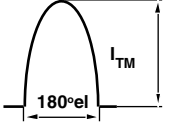
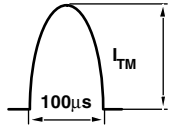
Frequency							Units
50Hz	770	660	1220	1160	5450	4960	A
400Hz	730	600	1270	1090	2760	2420	
1000Hz	600	490	1210	1040	1600	1370	
2500Hz	350	270	860	730	800	680	
Recovery voltage Vr	50	50	50	50	50	50	
Voltage before turn-on Vd	V_{DRM}		V_{DRM}		V_{DRM}		
Rise of on-state current di/dt	50	50	-	-	-	-	A/µs
Heatsink temperature	40	55	40	55	40	55	°C
Equivalent values for RC circuit	47Ω / 0.22µF		47Ω / 0.22µF		47Ω / 0.22µF		

On-state Conduction

Parameter	ST183C..C	Units	Conditions		
$I_{T(AV)}$ Max. average on-state current @ Heatsink temperature	370 (130)	A	180° conduction, half sine wave double side (single side) cooled		
	55 (85)	°C			
$I_{T(RMS)}$ Max. RMS on-state current	690	A	DC @ 25°C heatsink temperature double side cooled		
I_{TSM} Max. peak, one half cycle, non-repetitive surge current	4900		t = 10ms	No voltage	Sinusoidal half wave, Initial $T_J = T_{J \text{ max}}$
	5130		t = 8.3ms	reapplied	
	4120		t = 10ms	100% V_{RRM}	
4310	t = 8.3ms	reapplied			
I^2t Maximum I^2t for fusing	120	KA ² s	t = 10ms	No voltage	
	110		t = 8.3ms	reapplied	
	85		t = 10ms	100% V_{RRM}	
	78		t = 8.3ms	reapplied	
$I^2\sqrt{t}$ Maximum $I^2\sqrt{t}$ for fusing	1200	KA ² √s	t = 0.1 to 10ms, no voltage reapplied		

On-state Conduction

Parameter	ST183C..C	Units	Conditions
V_{TM} Max. peak on-state voltage	1.80	V	$I_{TM} = 600A$, $T_J = T_J \text{ max}$, $t_p = 10\text{ms}$ sine wave pulse
$V_{T(TO)1}$ Low level value of threshold voltage	1.40		$(16.7\% \times \pi \times I_{T(AV)} < I < \pi \times I_{T(AV)})$, $T_J = T_J \text{ max}$.
$V_{T(TO)2}$ High level value of threshold voltage	1.45		$(I > \pi \times I_{T(AV)})$, $T_J = T_J \text{ max}$.
r_{t1} Low level value of forward slope resistance	0.67	m Ω	$(16.7\% \times \pi \times I_{T(AV)} < I < \pi \times I_{T(AV)})$, $T_J = T_J \text{ max}$.
r_{t2} High level value of forward slope resistance	0.58		$(I > \pi \times I_{T(AV)})$, $T_J = T_J \text{ max}$.
I_H Maximum holding current	600	mA	$T_J = 25^\circ\text{C}$, $I_T > 30A$
I_L Typical latching current	1000		$T_J = 25^\circ\text{C}$, $V_A = 12V$, $R_a = 6\Omega$, $I_G = 1A$

Switching

Parameter	ST183C..C	Units	Conditions
di/dt Max. non-repetitive rate of rise of turned-on current	1000	A/ μs	$T_J = T_J \text{ max}$, $V_{DRM} = \text{rated } V_{DRM}$ $I_{TM} = 2 \times di/dt$
t_d Typical delay time	1.1	μs	$T_J = 25^\circ\text{C}$, $V_{DM} = \text{rated } V_{DRM}$, $I_{TM} = 50A$ DC, $t_p = 1\mu\text{s}$ Resistive load, Gate pulse: 10V, 5 Ω source
t_q Max. turn-off time	Min: 10 Max: 20		$T_J = T_J \text{ max}$, $I_{TM} = 300A$, commutating $di/dt = 20A/\mu\text{s}$ $V_R = 50V$, $t_p = 500\mu\text{s}$, dv/dt : see table in device code

Blocking

Parameter	ST183C..C	Units	Conditions
dv/dt Maximum critical rate of rise of off-state voltage	500	V/ μs	$T_J = T_J \text{ max}$. linear to 80% V_{DRM} , higher value available on request
I_{RRM} / I_{DRM} Max. peak reverse and off-state leakage current	40	mA	$T_J = T_J \text{ max}$, rated V_{DRM}/V_{RRM} applied

Triggering

Parameter	ST183C..C	Units	Conditions
P_{GM} Maximum peak gate power	60	W	$T_J = T_J \text{ max}$, $f = 50\text{Hz}$, $d\% = 50$
$P_{G(AV)}$ Maximum average gate power	10		
I_{GM} Max. peak positive gate current	10	A	$T_J = T_J \text{ max}$, $t_p \leq 5\text{ms}$
$+V_{GM}$ Maximum peak positive gate voltage	20	V	$T_J = T_J \text{ max}$, $t_p \leq 5\text{ms}$
$-V_{GM}$ Maximum peak negative gate voltage	5		
I_{GT} Max. DC gate current required to trigger	200	mA	$T_J = 25^\circ\text{C}$, $V_A = 12V$, $R_a = 6\Omega$
V_{GT} Max. DC gate voltage required to trigger	3		
I_{GD} Max. DC gate current not to trigger	20	mA	$T_J = T_J \text{ max}$, rated V_{DRM} applied
V_{GD} Max. DC gate voltage not to trigger	0.25		

ST183C..C Series

Bulletin I25178 rev. B 04/00



Thermal and Mechanical Specification

Parameter	ST183C..C	Units	Conditions
T _J Max. operating temperature range	-40 to 125	°C	
T _{stg} Max. storage temperature range	-40 to 150		
R _{thJ-hs} Max. thermal resistance, junction to heatsink	0.17	K/W	DC operation single side cooled
	0.08		DC operation double side cooled
R _{thC-hs} Max. thermal resistance, case to heatsink	0.033	K/W	DC operation single side cooled
	0.017		DC operation double side cooled
F Mounting force, ± 10%	4900 (500)	N (Kg)	
wt Approximate weight	50	g	
Case style	TO - 200AB (A-PUK)		See Outline Table

ΔR_{thJ-hs} Conduction

(The following table shows the increment of thermal resistance R_{thJ-hs} when devices operate at different conduction angles than DC)

Conduction angle	Sinusoidal conduction		Rectangular conduction		Units	Conditions
	Single Side	Double Side	Single Side	Double Side		
180°	0.015	0.016	0.011	0.011	K/W	T _J = T _J max.
120°	0.018	0.019	0.019	0.019		
90°	0.024	0.024	0.026	0.026		
60°	0.035	0.035	0.036	0.037		
30°	0.060	0.060	0.060	0.061		

Ordering Information Table

Device Code

ST	18	3	C	08	C	H	K	1	
1	2	3	4	5	6	7	8	9	10

1 - Eyelet term. (Gate and Aux. Cathode Unsoldered Leads)
2 - Eyelet term. (Gate and Aux. Cathode Soldered Leads)
3 - Fast-on term. (Gate and Aux. Cathode Soldered Leads)

10 - None = 500V/μsec (Standard value)
L = 1000V/μsec (Special selection)

dv/dt - t_q combinations available

dv/dt (V/μs)	20	50	100	200	400
10	CN	DN	EN	FN*	HN
12	CM	DM	EM	FM	HM
15	CL	DL	EL	FL*	HL
18	CP	DP	EP	FP	HP
20	CK	DK	EK	FK	HK

*Standard part number.
All other types available only on request.

Outline Table

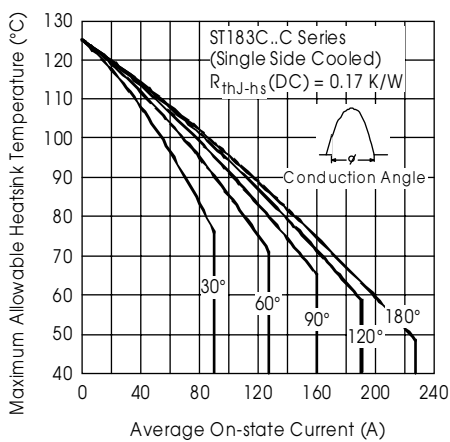
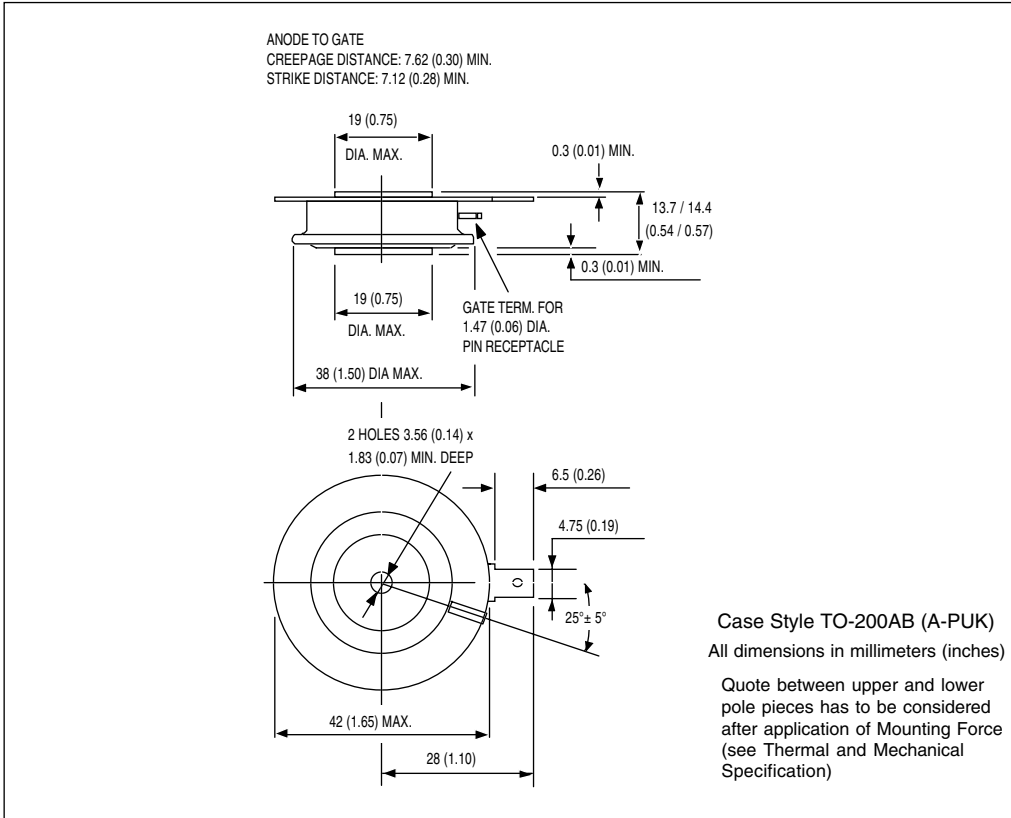

Fig. 1 - Current Ratings Characteristics

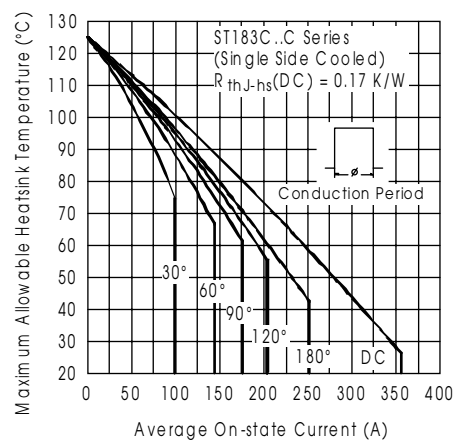

Fig. 2 - Current Ratings Characteristics

ST183C..C Series

Bulletin I25178 rev. B 04/00

International
IOR Rectifier

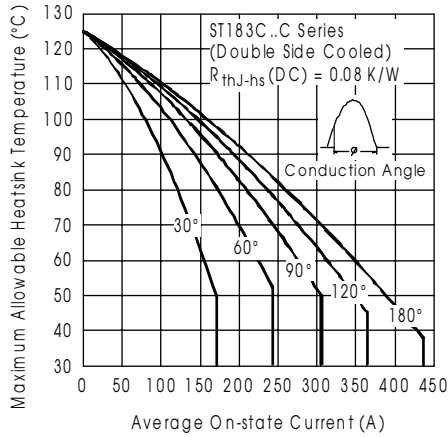

Fig. 3 - Current Ratings Characteristics

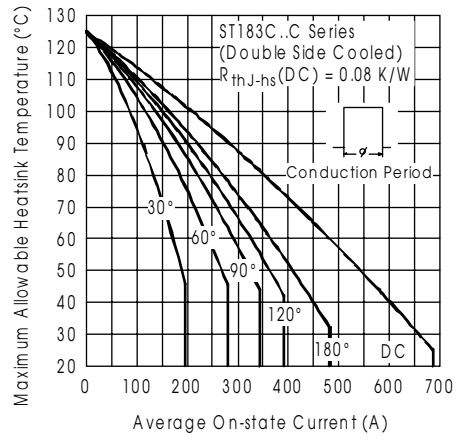

Fig. 4 - Current Ratings Characteristics

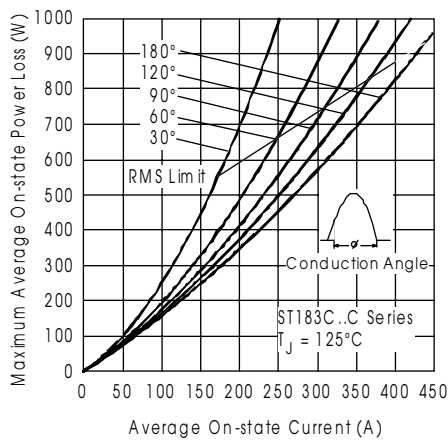

Fig. 5 - On-state Power Loss Characteristics

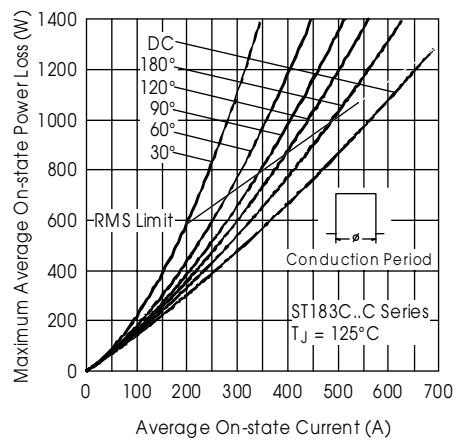

Fig. 6 - On-state Power Loss Characteristics

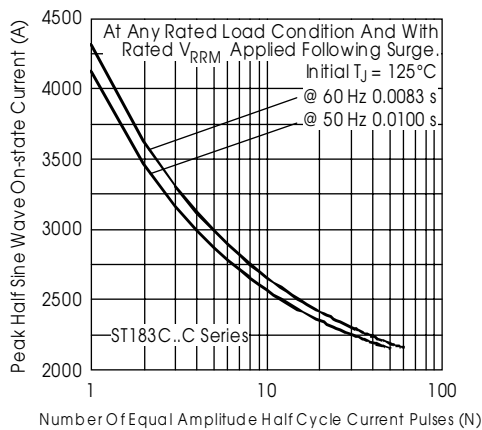

Fig. 7 - Maximum Non-repetitive Surge Current Single and Double Side Cooled

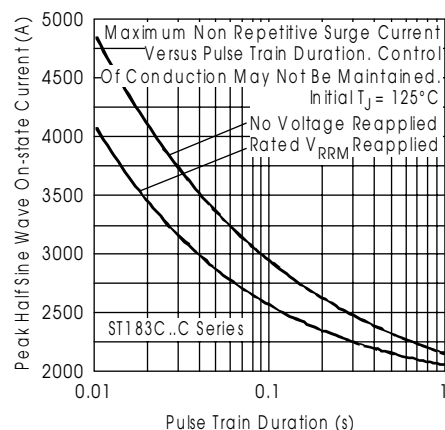

Fig. 8 - Maximum Non-repetitive Surge Current Single and Double Side Cooled

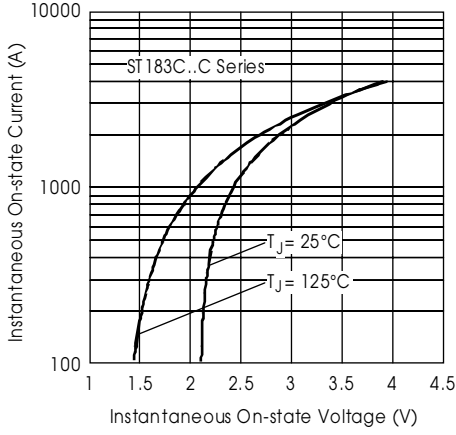

Fig. 9 - On-state Voltage Drop Characteristics

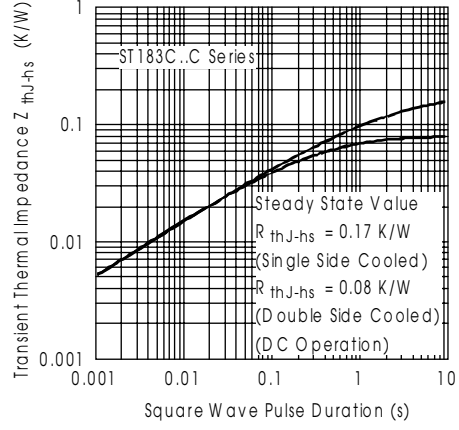

Fig. 10 - Thermal Impedance Z_{thj-hs} Characteristics

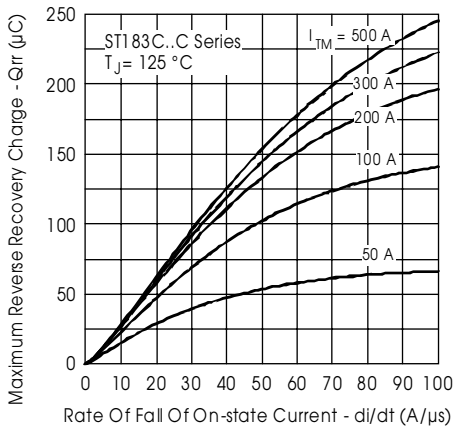

Fig. 11 - Reverse Recovered Charge Characteristics

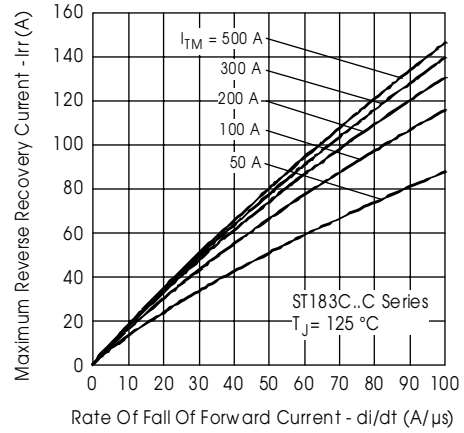

Fig. 12 - Reverse Recovery Current Characteristics

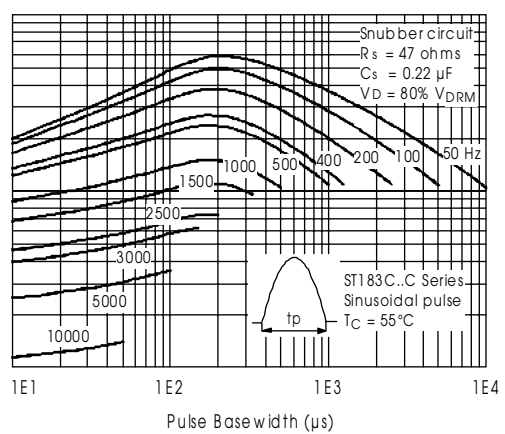
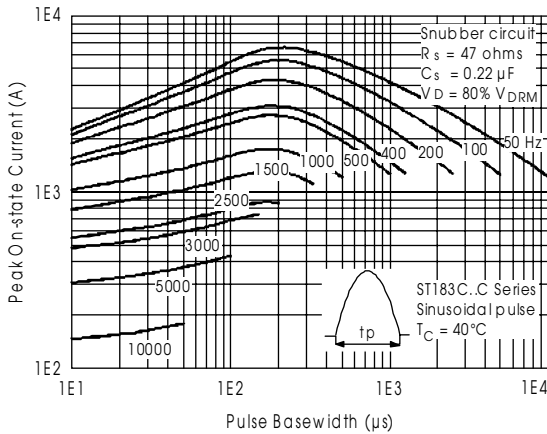

Fig. 13 - Frequency Characteristics

ST183C..C Series

Bulletin I25178 rev. B 04/00

International
VIOR Rectifier

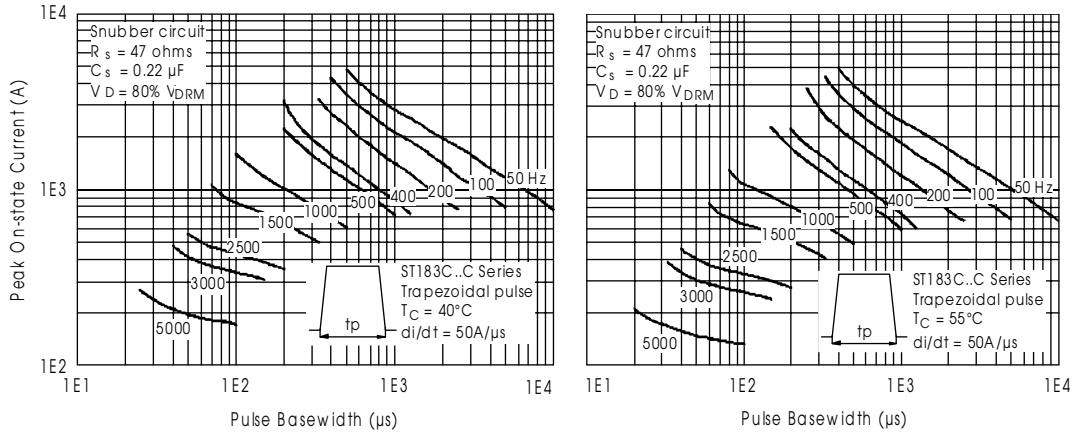

Fig. 14 - Frequency Characteristics

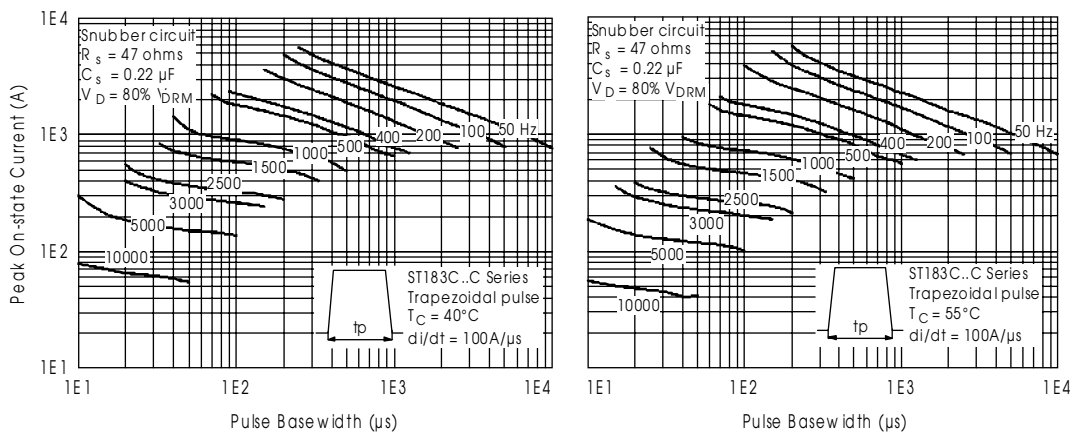

Fig. 15 - Frequency Characteristics

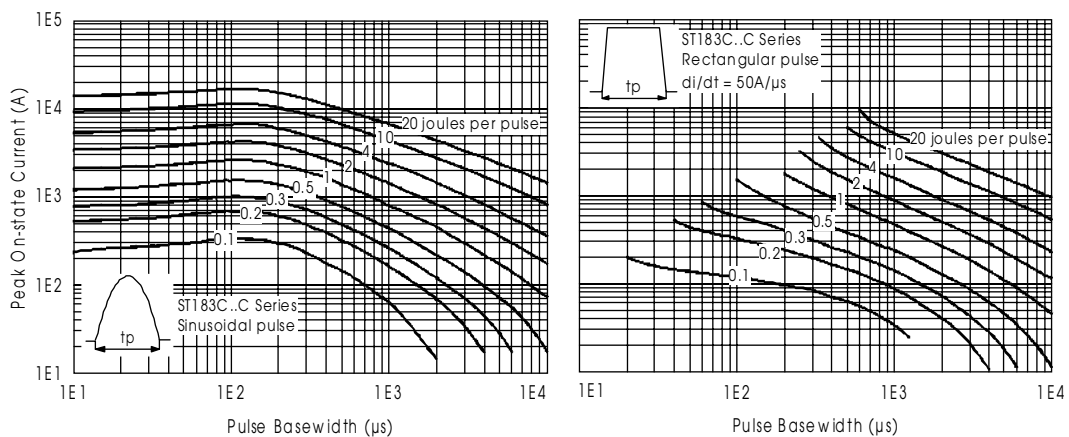

Fig. 16 - Maximum On-state Energy Power Loss Characteristics

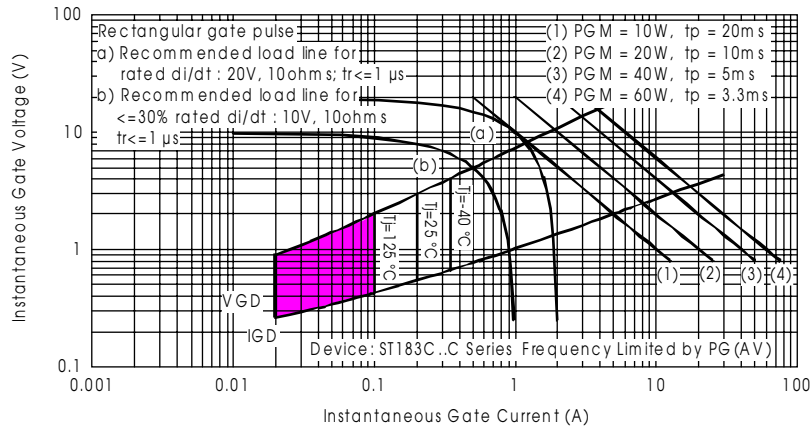

Fig. 17 - Gate Characteristics



Notice

The products described herein were acquired by Vishay Intertechnology, Inc., as part of its acquisition of International Rectifier's Power Control Systems (PCS) business, which closed in April 2007. Specifications of the products displayed herein are pending review by Vishay and are subject to the terms and conditions shown below.

Specifications of the products displayed herein are subject to change without notice. Vishay Intertechnology, Inc., or anyone on its behalf, assumes no responsibility or liability for any errors or inaccuracies.

Information contained herein is intended to provide a product description only. No license, express or implied, by estoppel or otherwise, to any intellectual property rights is granted by this document. Except as provided in Vishay's terms and conditions of sale for such products, Vishay assumes no liability whatsoever, and disclaims any express or implied warranty, relating to sale and/or use of Vishay products including liability or warranties relating to fitness for a particular purpose, merchantability, or infringement of any patent, copyright, or other intellectual property right.

The products shown herein are not designed for use in medical, life-saving, or life-sustaining applications. Customers using or selling these products for use in such applications do so at their own risk and agree to fully indemnify Vishay for any damages resulting from such improper use or sale.

International Rectifier®, IR®, the IR logo, HEXFET®, HEXSense®, HEXDIP®, DOL®, INTERO®, and POWIRTRAIN® are registered trademarks of International Rectifier Corporation in the U.S. and other countries. All other product names noted herein may be trademarks of their respective owners.