



Size:
9.0 x 4.13 x 1.72 inches
228.5 x 105.0 x 44.0 mm



FEATURES

- RoHS Compliant
- 600 Watts Output Power
- High Power Density
- Single Outputs
- PFC Function, PF > 0.95
- 90~93% High Efficiency
- Built-in Fan
- Remote On/Off Control
- Current Sharing Function
- Power Good Function
- Universal Input Voltage Range: 90-264VAC (120-370VDC)
- Short Circuit, Over Load, Over Voltage, and Over Temperature Protection
- CE and UL/cUL 60950-1 Approvals

DESCRIPTION

The PSAQF600 series of AC/DC switching power supplies provides up to 600 Watts of output power in a 9.0" x 4.13" x 1.72" enclosed package. This series consists of single output models with a universal input voltage range of 90-264VAC (120-370VDC). Some features include 90~93% high efficiency, power factor > 0.95, remote on/off control, and current sharing and power good functions. All supplies are short circuit, over load, over voltage, and over temperature protected. The PSAQF600 series is RoHS compliant and has UL/cUL 60950-1 safety approvals.

MODEL SELECTION TABLE

Model Number	Input Voltage Range	Output Voltage	Output Current (Convection)		Output Power (Convection)	Efficiency	Maximum Capacitive Load
			Min ⁽¹⁾	Max			
PSAQF600-12S	90~264 VAC or 120~370 VDC	12 VDC	450mA	45A	540W	90%	90,000µF
PSAQF600-24S		24 VDC	250mA	25A	600W	92%	70,000µF
PSAQF600-48S		48 VDC	125mA	12.5A	600W	92%	30,000µF
PSAQF600-54S		54 VDC	111mA	11.1A	600W	93%	20,000µF

NOTES

1. The PSAQF600 series requires a minimum load on the output to maintain all specified regulations. Operation under no-load conditions will not damage these devices; however they may not meet all listed specifications.

DERATING

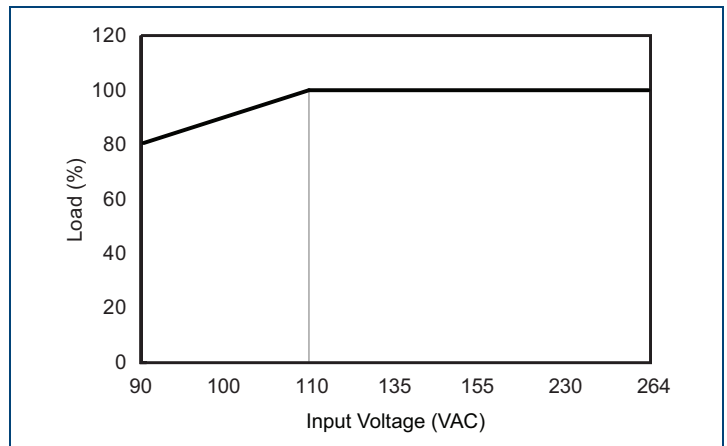
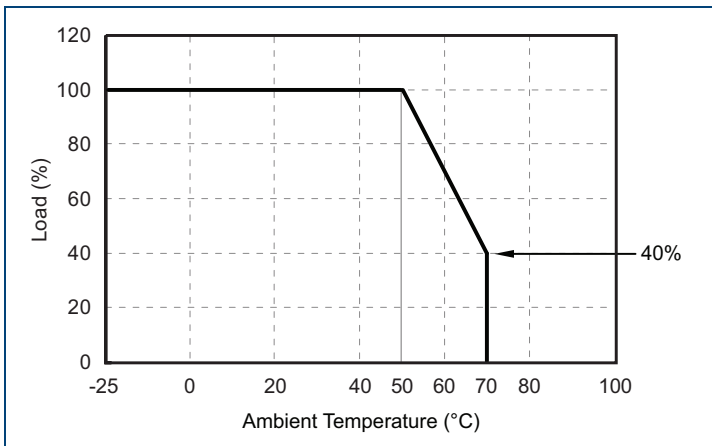

SPECIFICATIONS: PSAQF600 SERIES

All specifications are based on 25°C, Nominal Input Voltage, and Maximum Output Current unless otherwise noted.
 We reserve the right to change specifications based on technological advances.

SPECIFICATION	TEST CONDITIONS	Min	Typ	Max	Unit
INPUT SPECIFICATIONS					
Input Voltage	AC input voltage range	90		264	VAC
	DC input voltage range	120		370	VDC
Input Frequency		47		63	Hz
Input Current	At 115VAC and full load			8.0	A
	At 230VAC and full load			3.5	
Inrush Current (<2ms)	At 115VAC			15	A
	At 230VAC			30	
Power Factor	At 115VAC and full load	0.99			
	At 230VAC and full load	0.95			
OUTPUT SPECIFICATIONS					
Output Voltage		See Table			
Voltage Accuracy		-2		+2	%
Trim		-5		+5	%
Line Regulation	LL to HL	-1		+1	%
Load Regulation	5% to 100% full load	-1		+1	%
Output Power		See Table			
Output Current		See Table			
Minimum Load		1			%
Ripple & Noise	Measured at 20MHz BW with 0.1µF and 47µF capacitors in parallel			1	%
Max Capacitive Load		See Table			
Hold-Up Time		15			ms
Temperature Coefficient	0~50°C	-0.03		+0.03	%/°C
PROTECTION					
Short Circuit Protection		Latch off			
Over Voltage Protection		auto-recovery			
Over Power Protection		auto-recovery			
Over Temperature Protection		auto-recovery			
GENERAL SPECIFICATIONS					
Efficiency		See Table			
Switching Frequency		90	100	110	KHz
Isolation Voltage	Input to Output	3000			VAC
	Input to FG	1500			
	Output to FG	500			
Leakage Current	At 240VAC / 63Hz			3.5	mA
FUNCTIONS					
5V Stand-by (18CFM fan)		5VSB: 5V@0.6A; Tolerance: ±10%; Ripple & Noise: 100mVp-p max.			
DC OK Signal (Power Good)	Turn ON	4~6V			
	Turn OFF	0~1V			
Remote On/Off Control (+RC/-RC)	Power ON	Open			
	Power OFF	short			
Current Sharing		CN4: CS, +V, -V are connected in parallel			
ENVIRONMENTAL SPECIFICATIONS					
Operating Temperature	With derating (see derating curve)	-25		+70	°C
Storage Temperature		-25		+85	°C
Humidity				95	% RH
Cooling		Built-in fan			
Vibration		10~500Hz, 2G 10min./1cycle, 60 min. each along X, Y, Z axes			
MTBF	25°C (MIL-HDBK-217F)	100,000			hours
PHYSICAL SPECIFICATIONS					
Weight		Approx. 2.26 lbs (1024g)			
Dimensions (L x W x H)		9.0 x 4.13 x 1.72 inches (228.5 x 105.0 x 44.0 mm)			
SAFETY & EMC					
Safety Approvals		UL/cUL 60950-1, CE			
EMC	EMI (Conducted and Radiated Emissions)	EN 55022 Class B, Radiated Class A			
	EMS (Noise Immunity)	EN 55024			

MECHANICAL DRAWING

Unit: inches (mm)

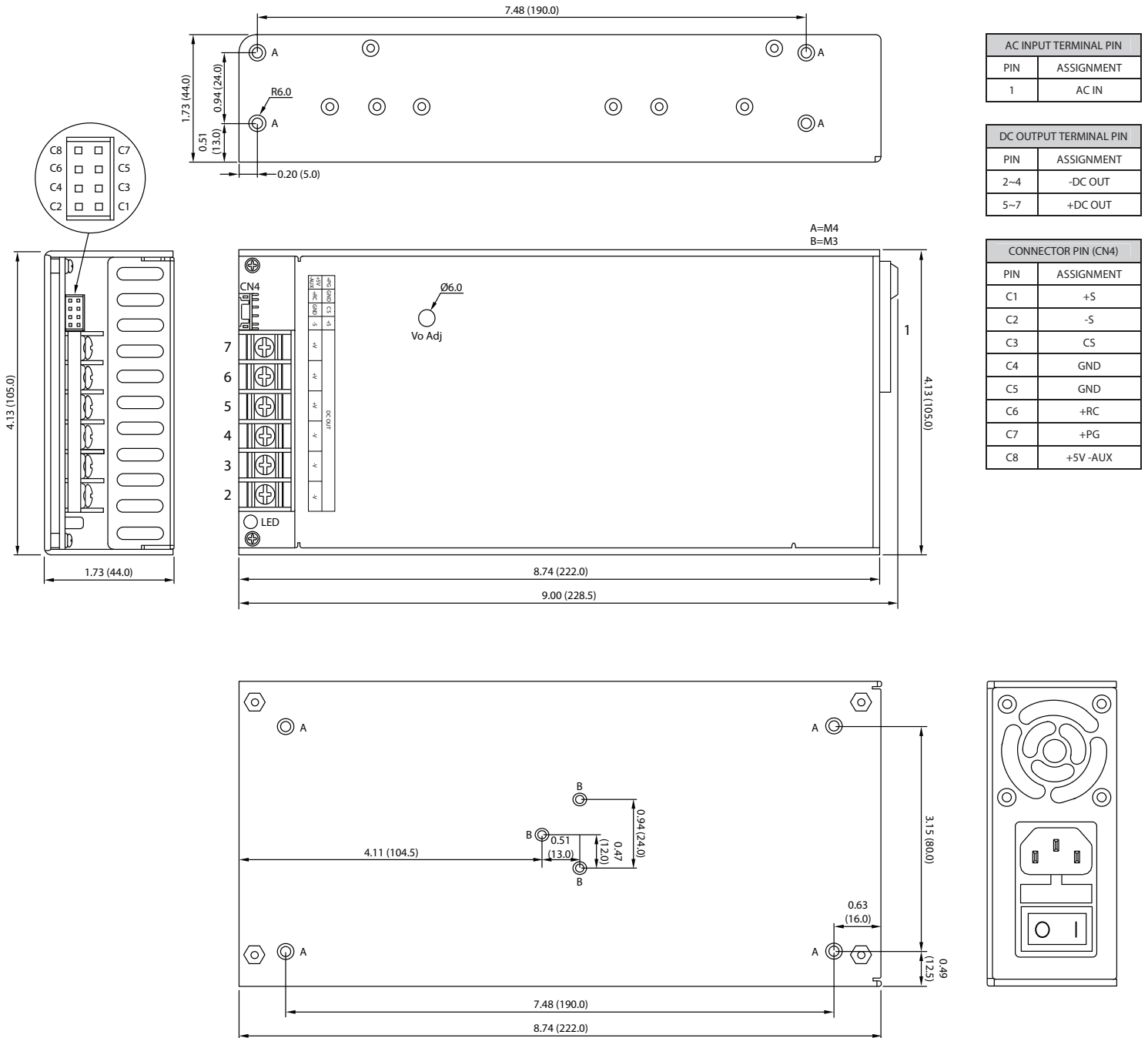

- NOTES**
1. Tolerance: $\pm 0.02"$ ($\pm 0.5\text{mm}$)
 2. Weight: 2.26 lbs (1024g)
 3. All dimensions are for reference only

- ASSEMBLY INSTRUCTIONS**
- *U Case T = 0.08" (2.0mm)
 - Customer screws into the length of the case no higher than 0.02" (0.5mm) (Namely screw length for load plate thickness plus 0.1" (2.5mm))

FUNCTION DESCRIPTION OF CN4

Pin Number	Function	Description
C1	+S	Current Share Function Pins
C2	-S	
C3	CS	
C4	GND	This pin connects to the negative terminal (-V). Return for DC-OK signal output.
C5	GND	This pin connects to the negative terminal (-V). Return for DC-OK signal output.
C6	+RC	Turns the output ON and OFF by electrical or dry contact between pin C4 (-RC), Short: Power OFF, Open: Power ON
C7	+PG	DC-OK Signal is a DC output, referenced to pin 6 (DC-OK GND).
C8	+5V-AUX	Stand-by voltage output ground 4.5~5V, referenced to pin C4 or C5 (GND). The maximum load current is 0.6A

FUNCTION MANUAL

1. DC-OK Signal

Between DC-OK (pin C5) and GND (pin C6)	Output Status
4~6V	ON
0~1V	OFF

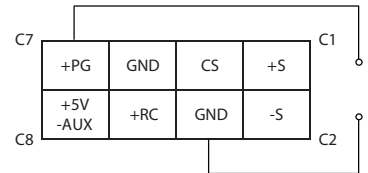
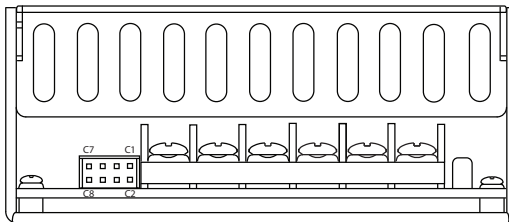

2. Remote Control

It can be turned ON/OFF by using the "Remote Control" function.

Between RC+ (pin C3) and RC- (pin C4)	Output Status
SW ON (Short)	OFF
SW OFF (Open)	ON

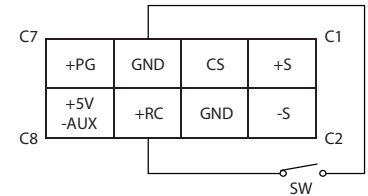
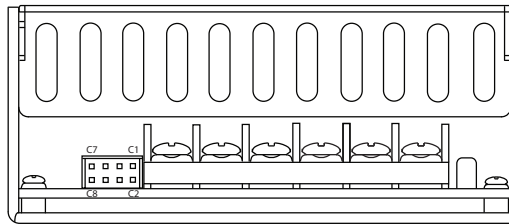

3. Current Sharing

1. The difference of Vout among parallel units should be less than $\pm 1\%$.
2. The power Pout should be less than 50%.
3. Three units is the maximum when in in parallel operation.
4. The power supplies should be connected in parallel to the load using short and large diameter wiring (twisted is ideal).

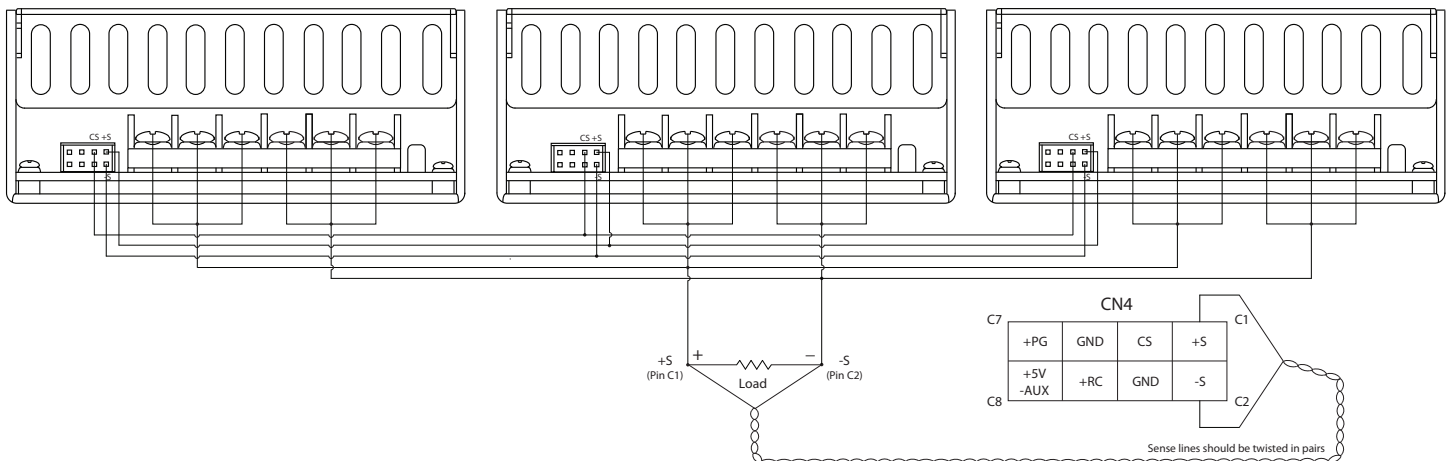

BLOCK DIAGRAM

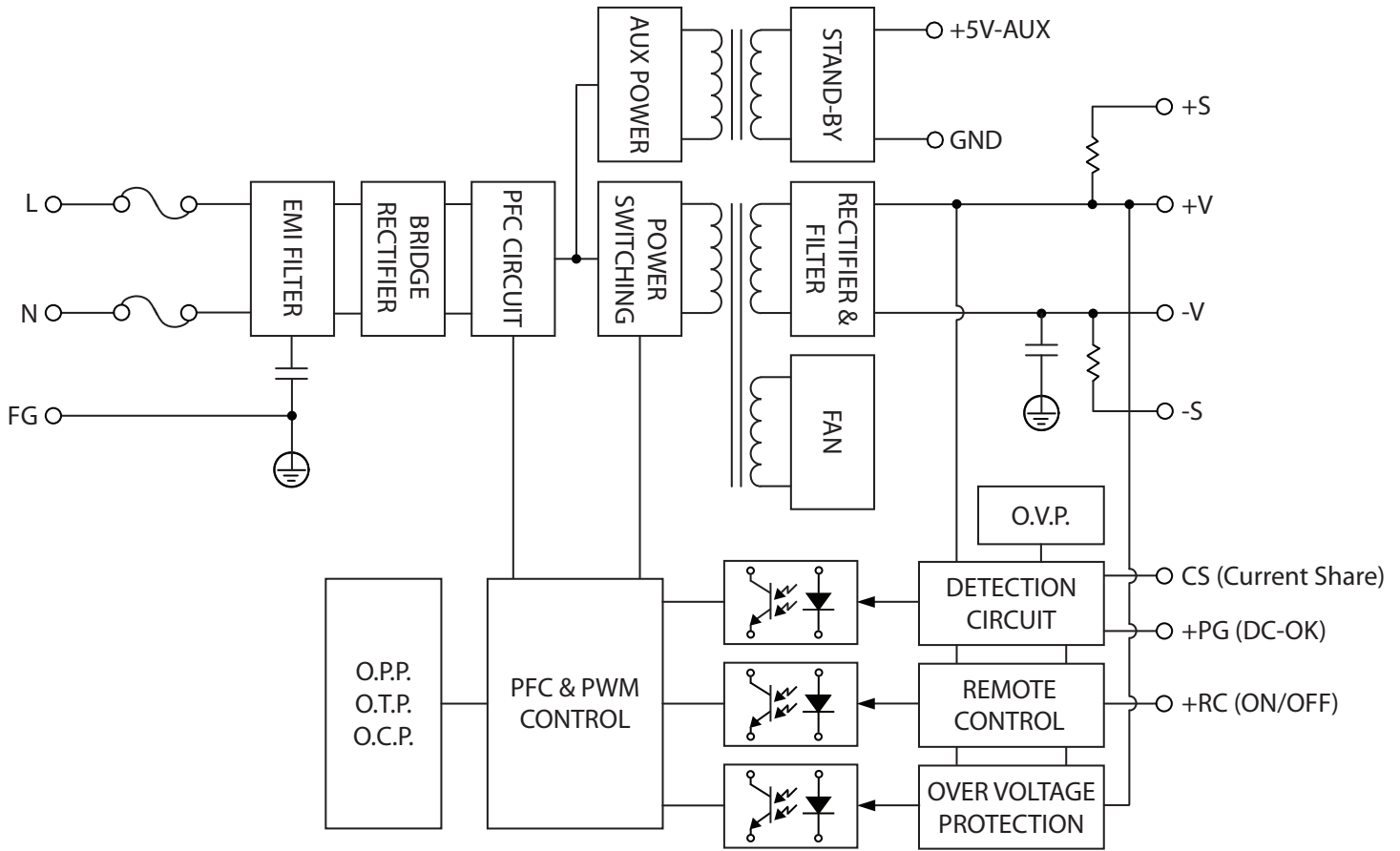

COMPANY INFORMATION

Wall Industries, Inc. has created custom and modified units for over 50 years. Our in-house research and development engineers will provide a solution that exceeds your performance requirements on-time and on budget. Our ISO9001-2008 certification is just one example of our commitment to producing a high quality, well-documented product for our customers.

Our past projects demonstrate our commitment to you, our customer. Wall Industries, Inc. has a reputation for working closely with its customers to ensure each solution meets or exceeds form, fit and function requirements. We will continue to provide ongoing support for your project above and beyond the design and production phases. Give us a call today to discuss your future projects.

Contact **Wall Industries** for further information:

Phone: ☎ (603)778-2300
 Toll Free: ☎ (888)597-9255
 Fax: ☎ (603)778-9797
 E-mail: sales@wallindustries.com
 Web: www.wallindustries.com
 Address: 5 Watson Brook Rd.
 Exeter, NH 03833