

IRLML6344TRPbF

HEXFET® Power MOSFET

V_{DS}	30	V
V_{GS Max}	± 12	V
R_{DS(on) max} (@ V _{GS} = 4.5V)	29	mΩ
R_{DS(on) max} (@ V _{GS} = 2.5V)	37	mΩ

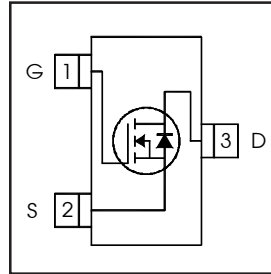

Application(s)

- Load/ System Switch

Features and Benefits

Low R _{DSon} (<29mΩ)
Industry-standard SOT-23 Package
RoHS compliant containing no lead, no bromide and no halogen
MSL1, Consumer Qualification

results in

Benefits

Lower Conduction Losses
Multi-vendor compatibility
Environmentally friendly
Increased Reliability

Absolute Maximum Ratings

Symbol	Parameter	Max.	Units
V _{DS}	Drain-Source Voltage	30	V
I _D @ T _A = 25°C	Continuous Drain Current, V _{GS} @ 10V	5.0	A
I _D @ T _A = 70°C	Continuous Drain Current, V _{GS} @ 10V	4.0	
I _{DM}	Pulsed Drain Current	25	
P _D @ T _A = 25°C	Maximum Power Dissipation	1.3	W
P _D @ T _A = 70°C	Maximum Power Dissipation	0.8	
	Linear Derating Factor	0.01	
V _{GS}	Gate-to-Source Voltage	± 12	V
T _J , T _{STG}	Junction and Storage Temperature Range	-55 to + 150	°C

Thermal Resistance

Symbol	Parameter	Typ.	Max.	Units
R _{θJA}	Junction-to-Ambient ③	—	100	°C/W
R _{θJA}	Junction-to-Ambient (t<10s) ④	—	99	

ORDERING INFORMATION:

See detailed ordering and shipping information on the last page of this data sheet.

Notes ① through ④ are on page 10

www.irf.com

IRLML6344TRPbF

International
IR Rectifier

Electric Characteristics @ $T_J = 25^\circ\text{C}$ (unless otherwise specified)

Symbol	Parameter	Min.	Typ.	Max.	Units	Conditions
$V_{(BR)DSS}$	Drain-to-Source Breakdown Voltage	30	—	—	V	$V_{GS} = 0V, I_D = 250\mu A$
$\Delta V_{(BR)DSS}/\Delta T_J$	Breakdown Voltage Temp. Coefficient	—	0.02	—	V/°C	Reference to $25^\circ\text{C}, I_D = 1mA$
$R_{DS(on)}$	Static Drain-to-Source On-Resistance	—	22	29	mΩ	$V_{GS} = 4.5V, I_D = 5.0A$ ②
		—	27	37		$V_{GS} = 2.5V, I_D = 4.0A$ ②
$V_{GS(th)}$	Gate Threshold Voltage	0.5	0.8	1.1	V	$V_{DS} = V_{GS}, I_D = 10\mu A$
I_{DSS}	Drain-to-Source Leakage Current	—	—	1.0	μA	$V_{DS} = 24V, V_{GS} = 0V$
		—	—	150		$V_{DS} = 24V, V_{GS} = 0V, T_J = 125^\circ\text{C}$
I_{GSS}	Gate-to-Source Forward Leakage	—	—	100	nA	$V_{GS} = 12V$
	Gate-to-Source Reverse Leakage	—	—	-100		$V_{GS} = -12V$
R_G	Internal Gate Resistance	—	1.7	—	Ω	
g_{fs}	Forward Transconductance	19	—	—	S	$V_{DS} = 10V, I_D = 5.0A$
Q_g	Total Gate Charge	—	6.8	—	nC	$I_D = 5.0A$
Q_{gs}	Gate-to-Source Charge	—	0.3	—		$V_{DS} = 15V$
Q_{gd}	Gate-to-Drain ("Miller") Charge	—	2.4	—		$V_{GS} = 4.5V$ ②
$t_{d(on)}$	Turn-On Delay Time	—	4.2	—	ns	$V_{DD} = 15V$ ②
t_r	Rise Time	—	5.6	—		$I_D = 1.0A$
$t_{d(off)}$	Turn-Off Delay Time	—	22	—		$R_G = 6.8\Omega$
t_f	Fall Time	—	9.1	—		$V_{GS} = 4.5V$
C_{iss}	Input Capacitance	—	650	—	pF	$V_{GS} = 0V$
C_{oss}	Output Capacitance	—	65	—		$V_{DS} = 25V$
C_{rss}	Reverse Transfer Capacitance	—	46	—		$f = 1.0MHz$

Source - Drain Ratings and Characteristics

Symbol	Parameter	Min.	Typ.	Max.	Units	Conditions
I_S	Continuous Source Current (Body Diode)	—	—	1.3	A	MOSFET symbol showing the integral reverse p-n junction diode.
I_{SM}	Pulsed Source Current (Body Diode) ①	—	—	25		
V_{SD}	Diode Forward Voltage	—	—	1.2	V	$T_J = 25^\circ\text{C}, I_S = 5.0A, V_{GS} = 0V$ ②
t_{rr}	Reverse Recovery Time	—	10	15	ns	$T_J = 25^\circ\text{C}, V_R = 15V, I_F = 1.3A$
Q_{rr}	Reverse Recovery Charge	—	3.8	5.7	nC	$di/dt = 100A/\mu s$ ②

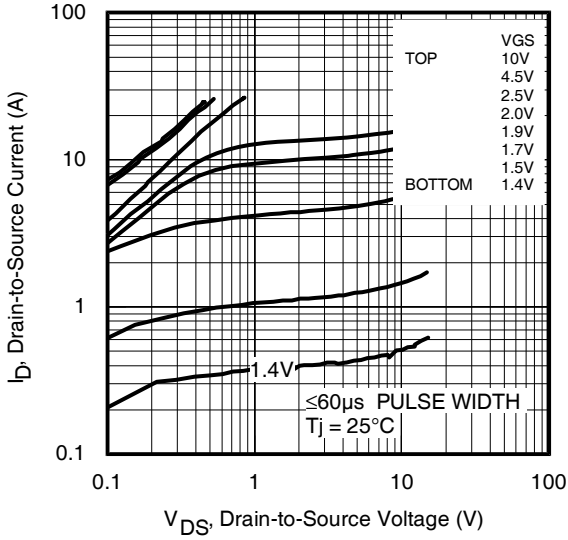

Fig 1. Typical Output Characteristics

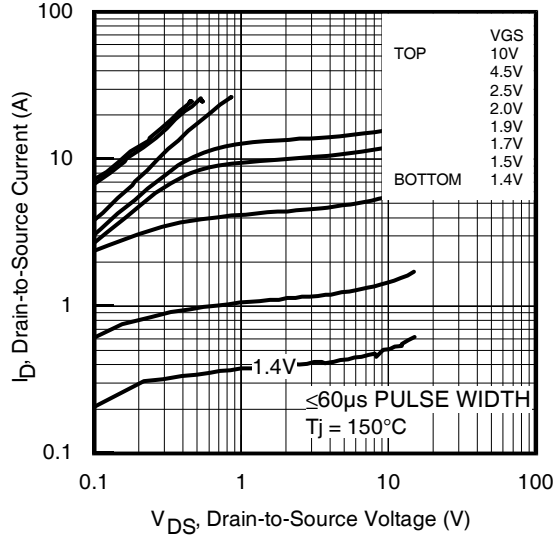

Fig 2. Typical Output Characteristics

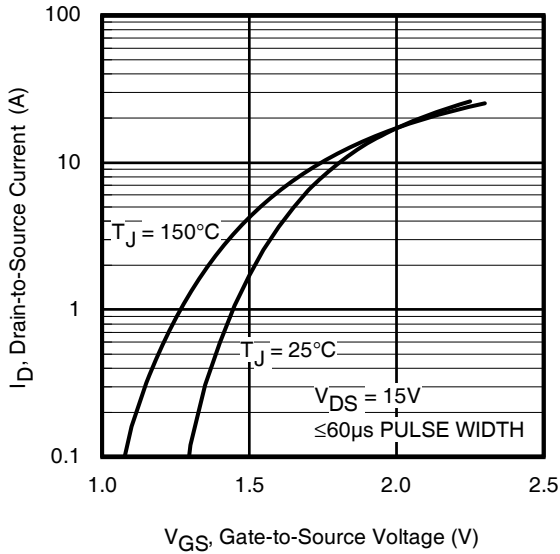

Fig 3. Typical Transfer Characteristics

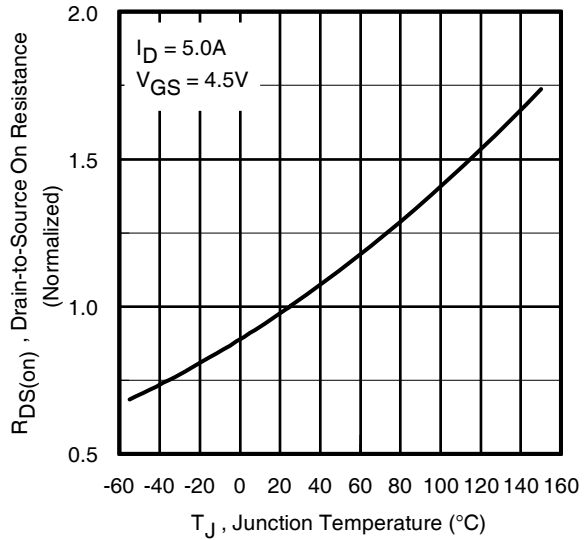

Fig 4. Normalized On-Resistance Vs. Temperature

IRLML6344TRPbF

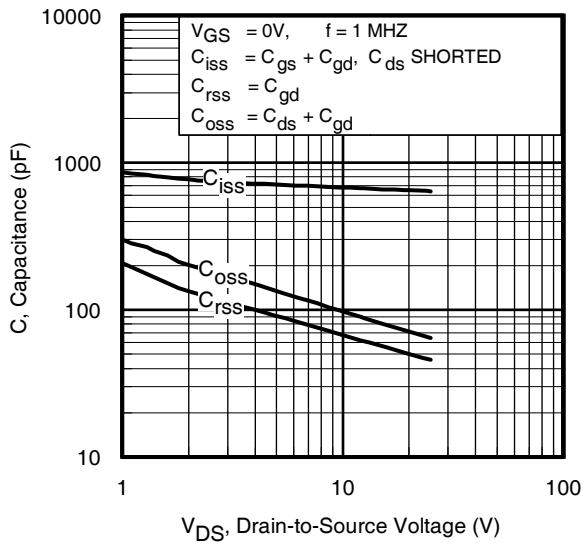

Fig 5. Typical Capacitance Vs. Drain-to-Source Voltage

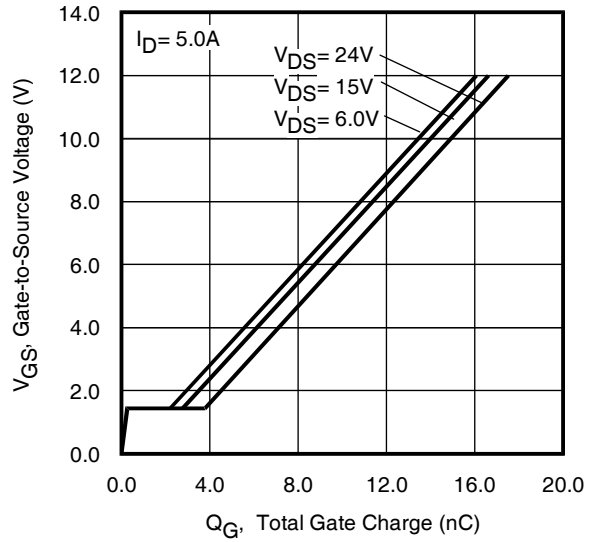

Fig 6. Typical Gate Charge Vs. Gate-to-Source Voltage

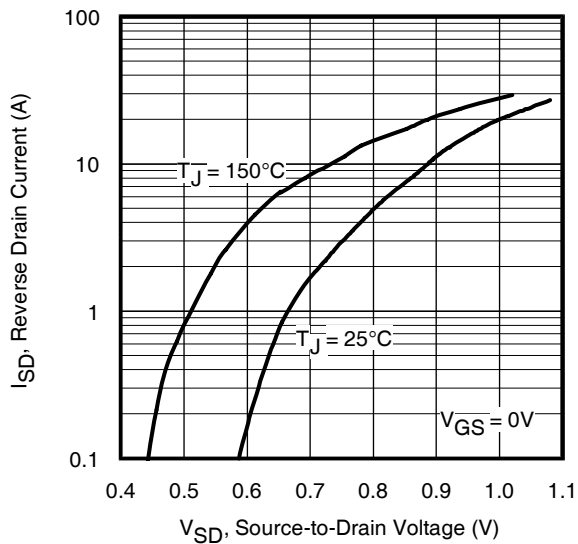

Fig 7. Typical Source-Drain Diode Forward Voltage

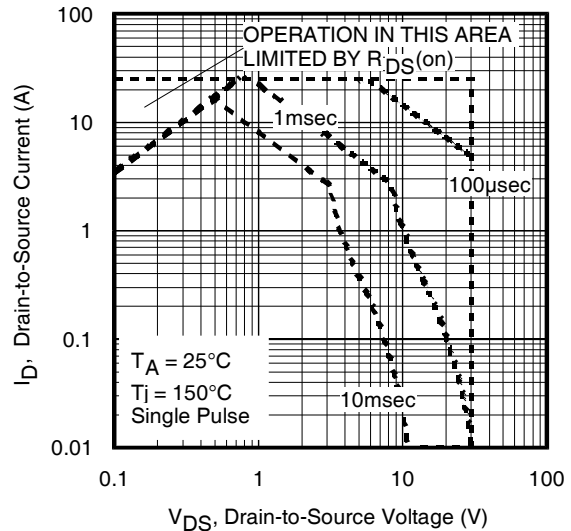

Fig 8. Maximum Safe Operating Area

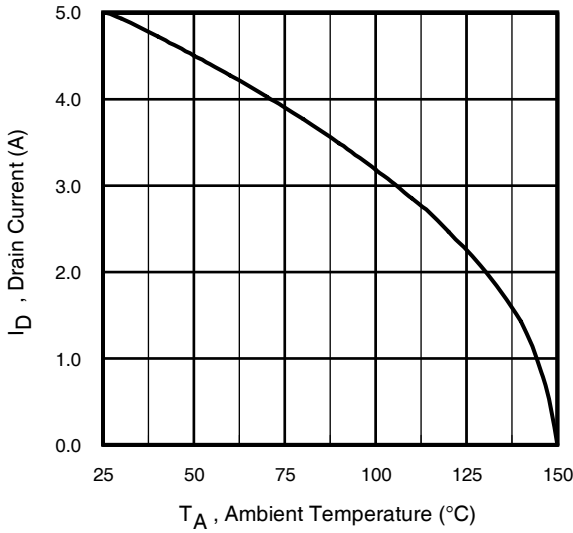

Fig 9. Maximum Drain Current Vs. Ambient Temperature

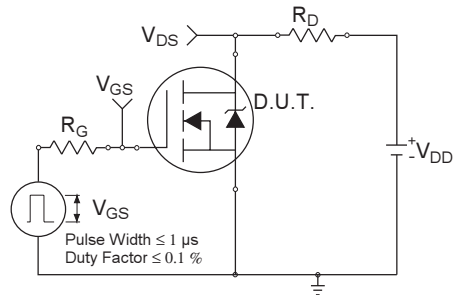

Fig 10a. Switching Time Test Circuit

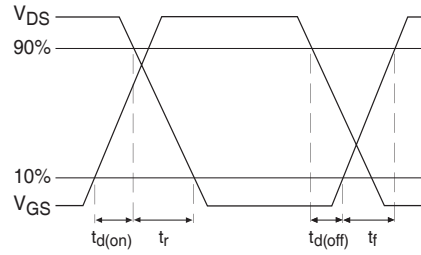

Fig 10b. Switching Time Waveforms

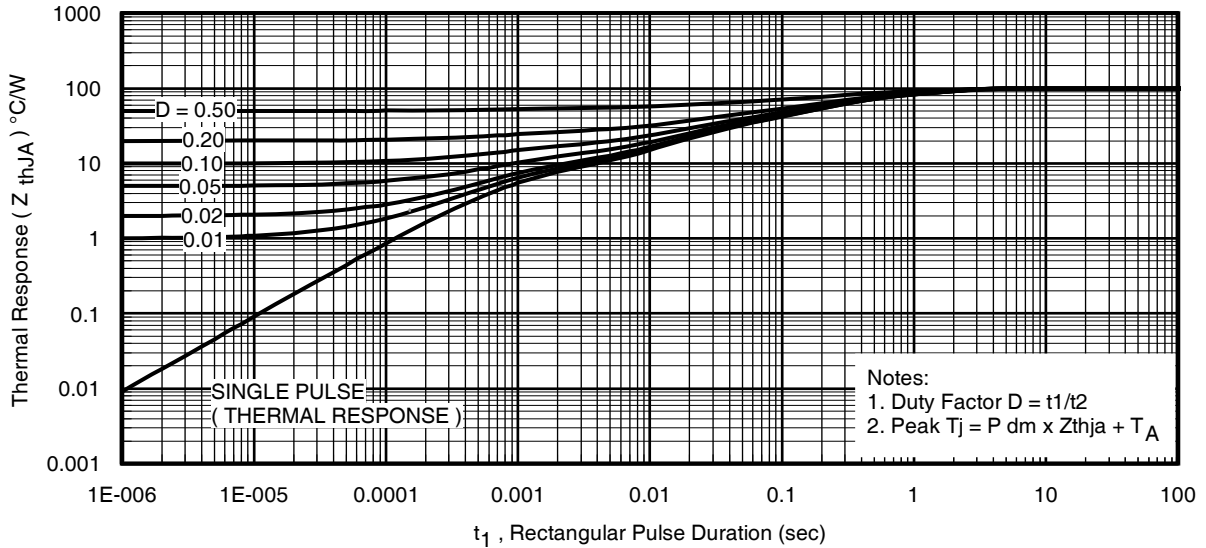

Fig 11. Typical Effective Transient Thermal Impedance, Junction-to-Ambient

IRLML6344TRPbF

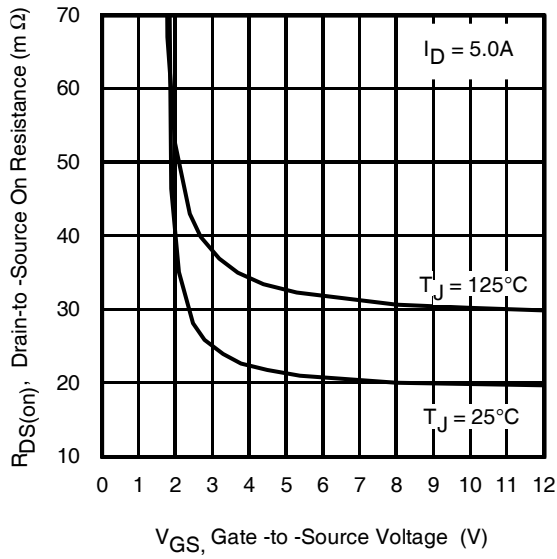

Fig 12. Typical On-Resistance Vs. Gate Voltage

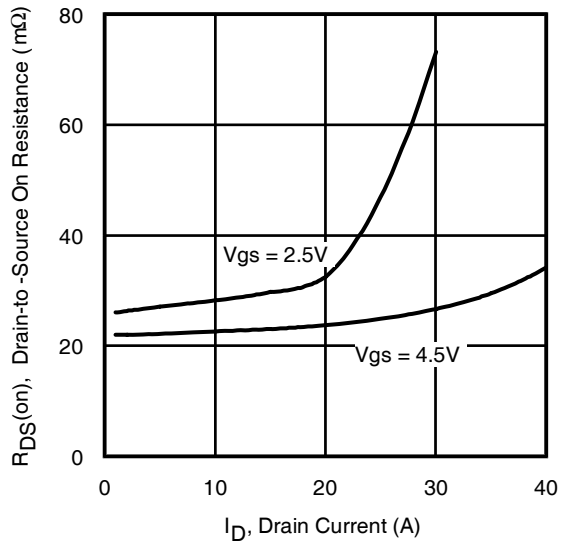

Fig 13. Typical On-Resistance Vs. Drain Current

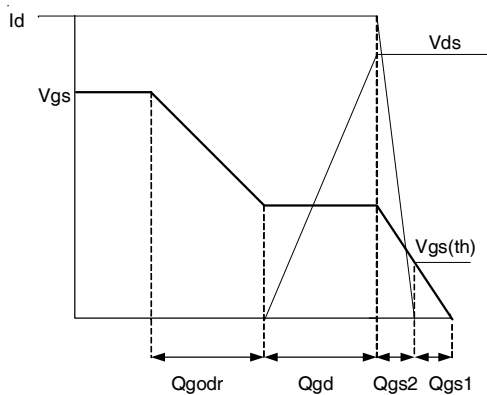

Fig 14a. Basic Gate Charge Waveform

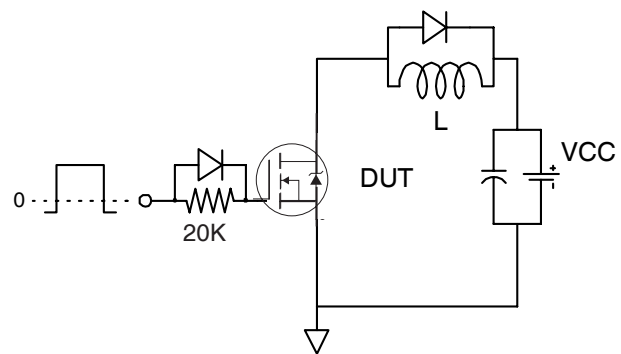

Fig 14b. Gate Charge Test Circuit

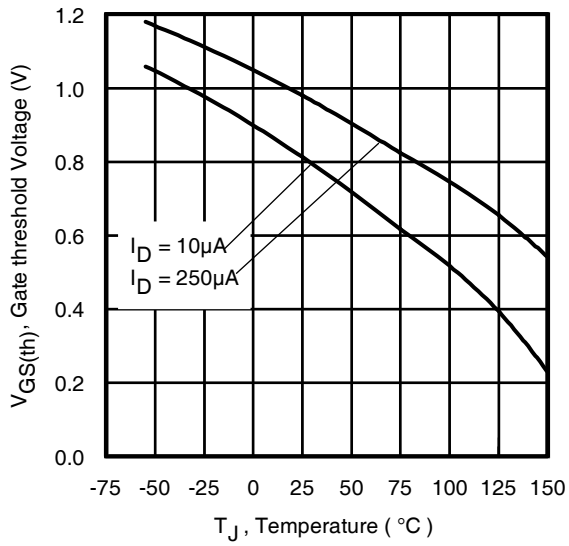

Fig 15. Typical Threshold Voltage Vs. Junction Temperature

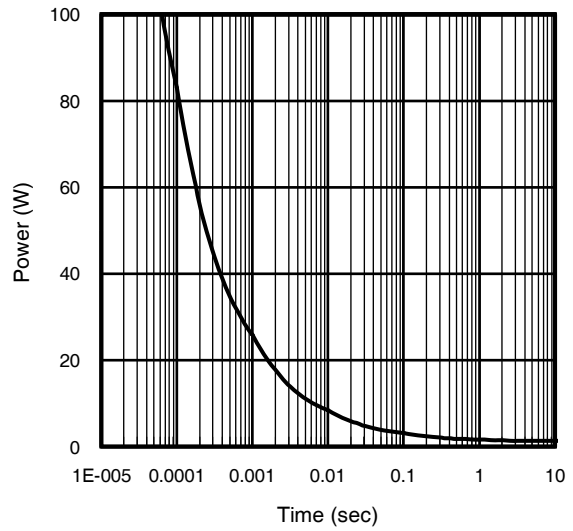

Fig 16. Typical Power Vs. Time

IRLML6344TRPbF



Micro3™(SOT-23) Package Outline

Dimensions are shown in millimeters (inches)

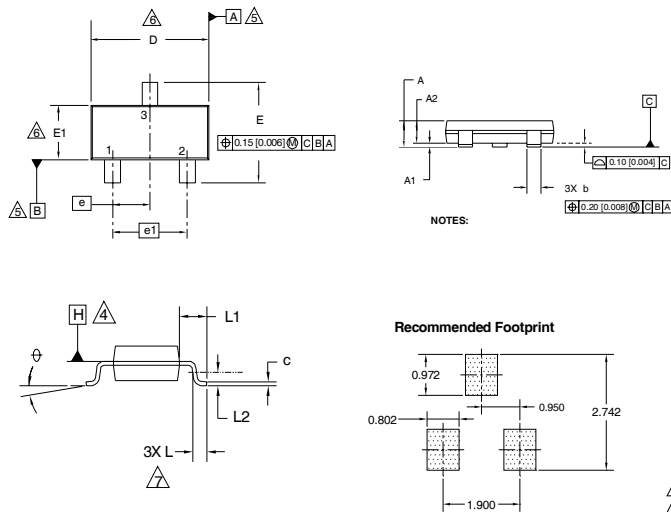

DIMENSIONS				
SYMBOL	MILLIMETERS		INCHES	
	MIN	MAX	MIN	MAX
A	0.89	1.12	0.035	0.044
A1	0.01	0.10	0.0004	0.004
A2	0.88	1.02	0.035	0.040
b	0.30	0.50	0.012	0.020
c	0.08	0.20	0.003	0.008
D	2.80	3.04	0.110	0.120
E	2.10	2.64	0.083	0.104
E1	1.20	1.40	0.047	0.055
e	0.95	BSC	0.037	BSC
e1	1.90	BSC	0.075	BSC
L	0.40	0.60	0.016	0.024
L1	0.54	REF	0.021	REF
L2	0.25	BSC	0.010	BSC
⌀	0	8	0	8

1. DIMENSIONING & TOLERANCING PER ANSI Y14.5M-1994
2. DIMENSIONS ARE SHOWN IN MILLIMETERS (INCHES)
3. CONTROLLING DIMENSION: MILLIMETER
4. DATUM PLANE H IS LOCATED AT THE MOLD PARTING LINE
5. DATUM A AND B TO BE DETERMINED AT DATUM PLANE H
6. DIMENSIONS D AND E1 ARE MEASURED AT DATUM PLANE H. DIMENSIONS DOES NOT INCLUDE MOLD PROTRUSIONS OR INTERLEAD FLASH. MOLD PROTRUSIONS OR INTERLEAD FLASH SHALL NOT EXCEED 0.25 MM (0.010 INCH) PER SIDE.
7. DIMENSION L IS THE LEAD LENGTH FOR SOLDERING TO A SUBSTRATE.
8. OUTLINE CONFORMS TO JEDEC OUTLINE TO-236 AB.

Micro3™(SOT-23) Part Marking Information

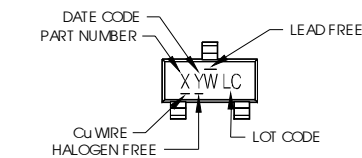

- X = PART NUMBER CODE REFERENCE:
- | | |
|---------------|---------------|
| A = IRLML2402 | S = IRLML6244 |
| B = IRLML2803 | T = IRLML6246 |
| C = IRLML6302 | U = IRLML6344 |
| D = IRLML5103 | V = IRLML6346 |
| E = IRLML6402 | |
| F = IRLML6401 | |
| G = IRLML2502 | |
| H = IRLML5203 | |
| I = IRLML0030 | |
| J = IRLML2030 | |
| K = IRLML0100 | |
| L = IRLML0060 | |
| M = IRLML0040 | |
| N = IRLML2060 | |
| P = IRLML9301 | |
| R = IRLML9303 | |

Note: A line above the work week (as shown here) indicates Lead-Free.

W = (1-26) IF PRECEDED BY LAST DIGIT OF CALENDAR YEAR

YEAR	Y	WORK WEEK	W
2001	1	01	A
2002	2	02	B
2003	3	03	C
2004	4	04	D
2005	5		
2006	6		
2007	7		
2008	8		
2009	9		
2010	0	24	X
		25	Y
		26	Z

W = (27-52) IF PRECEDED BY A LETTER

YEAR	Y	WORK WEEK	W
2001	A	27	A
2002	B	28	B
2003	C	29	C
2004	D	30	D
2005	E		
2006	F		
2007	G		
2008	H		
2009	J		
2010	K	50	X
		51	Y
		52	Z

Note: For the most current drawing please refer to IR website at: <http://www.irf.com/package/>

Micro3™(SOT-23) Tape & Reel Information

Dimensions are shown in millimeters (inches)

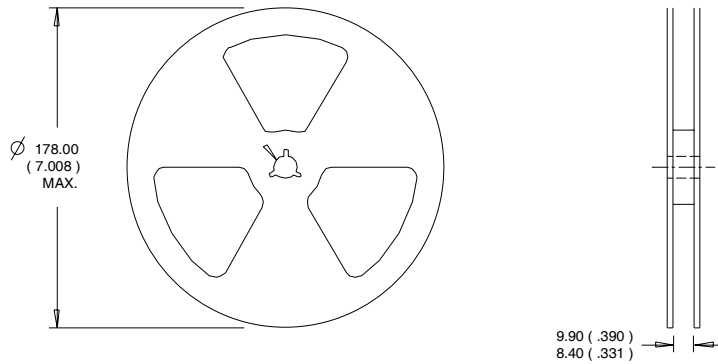
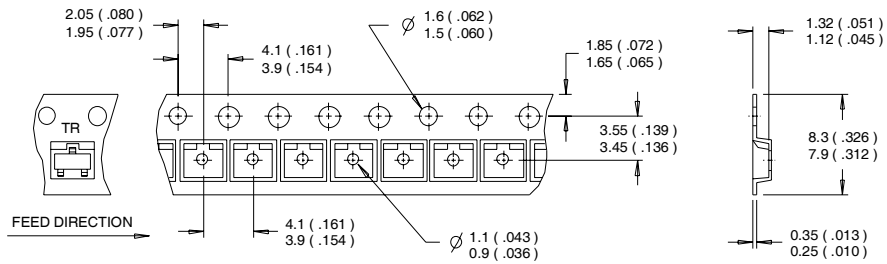

- NOTES:
 1. CONTROLLING DIMENSION : MILLIMETER.
 2. OUTLINE CONFORMS TO EIA-481 & EIA-541.

Note: For the most current drawing please refer to IR website at: <http://www.irf.com/package/>

IRLML6344TRPbF

International
IOR Rectifier

Orderable part number	Package Type	Standard Pack		Note
		Form	Quantity	
IRLML6344TRPbF	Micro3™(SOT-23)	Tape and Reel	3000	

Qualification information[†]

Qualification level	Consumer ^{††} (per JEDEC JESD47F ^{†††} guidelines)		
Moisture Sensitivity Level	Micro3™(SOT-23)	MSL1 (per IPC/JEDEC J-STD-020D ^{†††})	
RoHS compliant	Yes		

- † Qualification standards can be found at International Rectifier's web site
<http://www.irf.com/product-info/reliability>
- †† Higher qualification ratings may be available should the user have such requirements.
Please contact your International Rectifier sales representative for further information:
<http://www.irf.com/whoto-call/salesrep/>
- ††† Applicable version of JEDEC standard at the time of product release.

Notes:

- ① Repetitive rating; pulse width limited by max. junction temperature.
- ② Pulse width ≤ 400µs; duty cycle ≤ 2%.
- ③ Surface mounted on 1 in square Cu board
- ④ Refer to [application note #AN-994](#).

Data and specifications subject to change without notice.

International
IOR Rectifier

IR WORLD HEADQUARTERS: 233 Kansas St., El Segundo, California 90245, USA Tel: (310) 252-7105
TAC Fax: (310) 252-7903

Visit us at www.irf.com for sales contact information.10/2010