



OD1-B100H50U25

OD Mini

DISPLACEMENT MEASUREMENT SENSORS

SICK
Sensor Intelligence.



Ordering information

Type	Part no.
OD1-B100H50U25	6050514

Other models and accessories → www.sick.com/OD_Mini



Detailed technical data

Performance

Measuring range	50 mm ... 150 mm
Resolution	20 μm ¹⁾
Repeatability	30 μm ^{1) 2)}
Linearity	± 100 μm ^{3) 4)}
Response time	2 ms / 4 ms / 8 ms / 16 ms / auto ⁵⁾
Measuring frequency	2 kHz / 1 kHz / 500 Hz / 250 Hz / automatic
Light source	Laser, red
Laser class	1 (EN 60825-1) ⁶⁾
Typ. light spot size (distance)	700 μm x 600 μm (100 mm)
Additional function	Averaging 1 ... 512x, automatic or manual sensitivity adjustment, Analog outputs can be taught in, Switching outputs can be taught in, Invertable switching output, switching mode: window (Wnd), switching mode: distance to object (DtO), switching mode: object between sensor and background (ObSB), multifunctional input: laser-off / external teach-in / trigger

¹⁾ Averaging function set to: 512.

²⁾ Constant ambient conditions.

³⁾ Measurement on 90 % remission (ceramic, white)

⁴⁾ For best performance consider warm up time ≤ 5 minutes.

⁵⁾ With fixed sensitivity adjustment and averaging setting = 1. With automatic sensitivity and measuring rate 500 μs: 2 ... 7.5 ms response time/measuring rate
1,000 μs: 4 ... 15 ms response time.

⁶⁾ Wavelength: 655 nm, max. output: 390 μW (laser class 1) / < 1 mW (laser class 2)

Interfaces

Switching output	1 x PNP/NPN, selectable
Multifunctional input (MF)	1 x ¹⁾
Data interface	1 x 0 V ... 10 V (> 10 kΩ)

¹⁾ MF can be used as laser-off, trigger, external teach-in or deactivated.

Mechanics/electronics

Supply voltage V_s	DC 12 V (-5 %) ... DC 24 V (+10 %)
Power consumption	$\leq 1.92 \text{ W}^{1)}$
Warm-up time	$\leq 5 \text{ min}$
Housing material	Stainless steel housing with PPSU lens
Connection type	Cable with male connector, M12, 5-pin, 30 cm
Indication	4-digit 7-segment display (plus 4 LEDs for status display)
Operating elements	4 buttons
Weight	70 g
Dimensions	44.4 mm x 31 mm x 17 mm

¹⁾ Without load, with current output.

Ambient data

Enclosure rating	IP 67
Protection class	III
Ambient temperature	Operation: $-10 \text{ }^\circ\text{C} \dots +40 \text{ }^\circ\text{C}$ Storage: $-20 \text{ }^\circ\text{C} \dots +60 \text{ }^\circ\text{C}$
Min. rel. humidity (not condensing)	35 %
Max. rel. humidity (not condensing)	95 %
Temperature drift	$\pm 0.08 \text{ } \% \text{ FS/K}$ (FS = Full Scale = Measuring range of sensor)
Typ. Ambient light immunity	Artificial light: $\leq 3,000 \text{ lx}$ Sunlight: $\leq 10,000 \text{ lx}$
Vibration resistance	10 Hz ... 55 Hz (amplitude 1.5 mm, x-, y-, z-axis 2 hours each)
Shock resistance	50 G (x, y, z axis 3 times each)

General notes

Note	Not free of paint wetting impairment substances.
-------------	--

Dimensional drawing (Dimensions in mm (inch))

Stainless steel housing

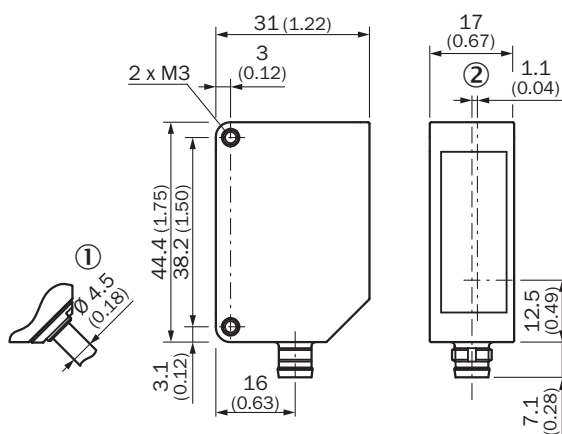

- ① Variant with 30 cm cable with M12, 5-pin connector
- ② Optical axis

Connection type

OD1-BxxxxxI25 OD1-BxxxxxU25 cable with 5-pin, M12 male connector

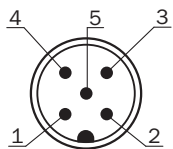

Connection diagram

OD1-BxxxxxI25 OD1-BxxxxxU25 cable with 5-pin, M12 male connector

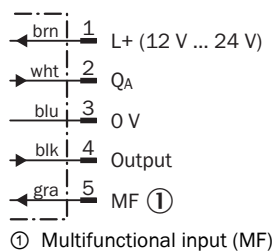

Adjustment possible

Adjustments

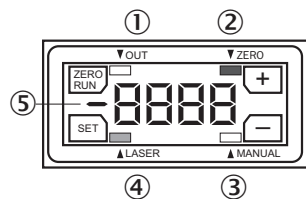

- ① Switching output status indicator
- ② Zero offset status indicator
- ③ Teach mode status indicator
- ④ Laser status indicator
- ⑤ Minus sign for measured value indicator

Light spot size

OD Mini Prime 50 mm ... 150 mm

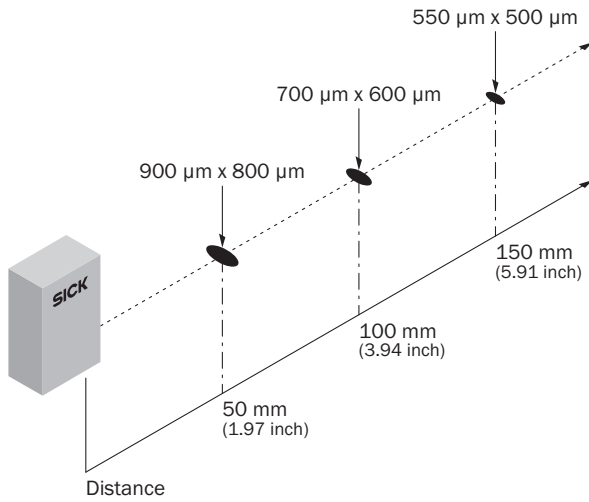

Linearity

OD Mini Prime 50 mm ... 150 mm

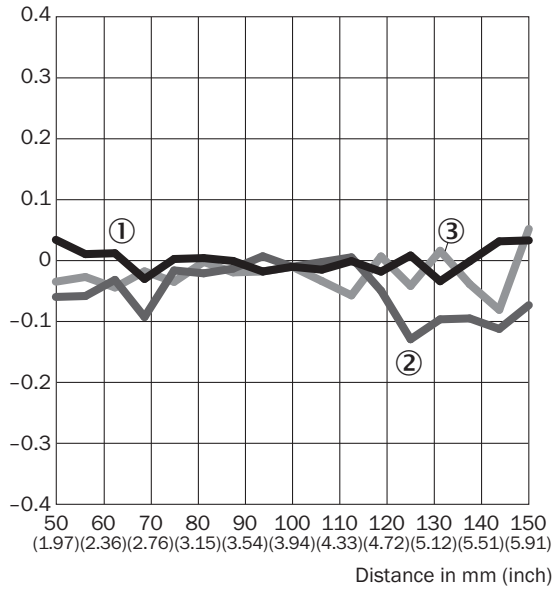

Linearity [% FS]



- ① White ceramic
- ② Stainless steel
- ③ Black rubber

Recommended accessories

Other models and accessories → www.sick.com/OD_Mini

	Brief description	Type	Part no.
Plug connectors and cables			
	Head A: female connector, M12, 5-pin, straight Head B: cable Cable: PVC, unshielded, 2 m	DOL-1205-G02M	6008899
	Head A: female connector, M12, 5-pin, straight Head B: cable Cable: drag chain use, PUR, halogen-free, unshielded, 2 m	DOL-1205-G02MC	6025906

SICK AT A GLANCE

SICK is one of the leading manufacturers of intelligent sensors and sensor solutions for industrial applications. A unique range of products and services creates the perfect basis for controlling processes securely and efficiently, protecting individuals from accidents and preventing damage to the environment.

We have extensive experience in a wide range of industries and understand their processes and requirements. With intelligent sensors, we can deliver exactly what our customers need. In application centers in Europe, Asia and North America, system solutions are tested and optimized in accordance with customer specifications. All this makes us a reliable supplier and development partner.

Comprehensive services complete our offering: SICK LifeTime Services provide support throughout the machine life cycle and ensure safety and productivity.

For us, that is “Sensor Intelligence.”

WORLDWIDE PRESENCE:

Contacts and other locations –www.sick.com