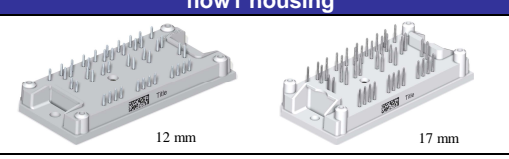
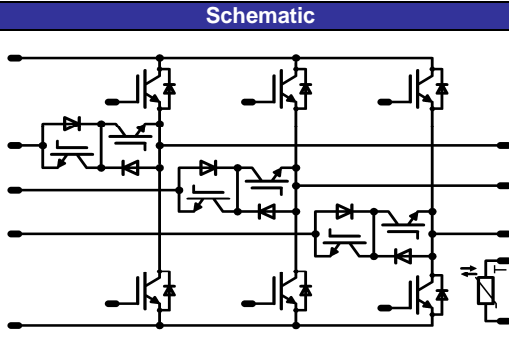

flow3xMNPC 1	1200V/40A
<div style="border: 1px solid black; padding: 5px; margin-bottom: 5px;"> <p style="text-align: center; background-color: #000080; color: white; margin: 0;">Features</p> <ul style="list-style-type: none"> 3 phase mixed voltage component topology neutral point clamped inverter reactive power capability low inductance layout </div> <div style="border: 1px solid black; padding: 5px; margin-bottom: 5px;"> <p style="text-align: center; background-color: #000080; color: white; margin: 0;">Target Applications</p> <ul style="list-style-type: none"> solar inverter UPS </div> <div style="border: 1px solid black; padding: 5px;"> <p style="text-align: center; background-color: #000080; color: white; margin: 0;">Types</p> <ul style="list-style-type: none"> 10-FY12M3A040SH-M749F08 10-F112M3A040SH-M749F09 </div>	<div style="border: 1px solid black; padding: 5px; margin-bottom: 5px;"> <p style="text-align: center; background-color: #000080; color: white; margin: 0;">flow1 housing</p>  </div> <div style="border: 1px solid black; padding: 5px;"> <p style="text-align: center; background-color: #000080; color: white; margin: 0;">Schematic</p>  </div>

Maximum Ratings

T_j=25°C, unless otherwise specified

Parameter	Symbol	Condition	Value	Unit
Half Bridge IGBT				
Collector-emitter break down voltage	V _{CE}		1200	V
DC collector current	I _C	T _j =T _{j,max} T _n =80°C T _c =80°C	31 41	A
Pulsed collector current	I _{C,pulse}	t _p limited by T _{j,max}	120	A
Power dissipation per IGBT	P _{tot}	T _j =T _{j,max} T _n =80°C T _c =80°C	75 114	W
Turn off safe operating area	I _C	T _j ≤150°C V _{CE} ≤V _{CES}	120	A
Short circuit ratings	t _{SC} V _{CC}	T _j ≤150°C V _{GE} =15V	10 800	μs V
Gate-emitter peak voltage	V _{GE}		±20	A
Maximum Junction Temperature	T _{j,max}		175	°C
Neutral Point FWD				
Peak Repetitive Reverse Voltage	V _{RRM}		600	V
DC forward current	I _F	T _j =T _{j,max} T _n =80°C T _c =80°C	18 26	A
Surge forward current	I _{FSM}	t _p limited by T _{j,max}	300	A
Power dissipation per Diode	P _{tot}	T _j =T _{j,max} T _n =80°C T _c =80°C	30 45	W
Maximum Junction Temperature	T _{j,max}		150	°C

Maximum Ratings

$T_j=25^{\circ}\text{C}$, unless otherwise specified

Parameter	Symbol	Condition	Value	Unit
-----------	--------	-----------	-------	------

Neutral Point IGBT

Collector-emitter break down voltage	V_{CE}		600	V
DC collector current	I_C	$T_j=T_{jmax}$ $T_h=80^{\circ}\text{C}$ $T_c=80^{\circ}\text{C}$	23 29	A
Pulsed collector current	I_{Cpuls}	t_p limited by T_{jmax}	90	A
Power dissipation per IGBT	P_{tot}	$T_j=T_{jmax}$ $T_h=80^{\circ}\text{C}$ $T_c=80^{\circ}\text{C}$	37 56	W
Gate-emitter peak voltage	V_{GE}		± 20	V
Short circuit ratings	t_{SC}	$T_j \leq 150^{\circ}\text{C}$	6	μs
	V_{CC}	$V_{GE}=15\text{V}$	360	V
Turn off safe operating area (RBSOA)	I_{Cmax}	$V_{CEmax} = 600\text{V}$ $T_{vjmax} = 150^{\circ}\text{C}$	90	A
Maximum Junction Temperature	T_{jmax}		175	$^{\circ}\text{C}$

Half Bridge FWD

Peak Repetitive Reverse Voltage	V_{RRM}		1200	V
DC forward current	I_F	$T_j=T_{jmax}$ $T_h=80^{\circ}\text{C}$ $T_c=80^{\circ}\text{C}$	12 14	A
Surge forward current	I_{FSM}	10 ms, sin 180° $T_j = 150^{\circ}\text{C}$	65	A
Power dissipation per Diode	P_{tot}	$T_j=T_{jmax}$ $T_h=80^{\circ}\text{C}$ $T_c=80^{\circ}\text{C}$	28	W
			43	
Maximum Junction Temperature	T_{jmax}		175	$^{\circ}\text{C}$

Thermal Properties

Storage temperature	T_{stg}		-40...+125	$^{\circ}\text{C}$
Operation temperature under switching condition	T_{op}		-40...+($T_{jmax} - 25$)	$^{\circ}\text{C}$

Insulation Properties

Insulation voltage	V_{is}	$t=2\text{s}$ DC voltage	4000	V
Creepage distance			min 12,7	mm
Clearance			min 12,7	mm

Characteristic Values

Parameter	Symbol	Conditions					Value			Unit
		V_{GE} [V] or V_{GS} [V]	V_i [V] or V_{CE} [V] or V_{DS} [V]	I_C [A] or I_F [A] or I_b [A]	T_j	Min	Typ	Max		
Half Bridge IGBT										
Gate emitter threshold voltage	$V_{GE(th)}$	$V_{CE}=V_{GE}$			0,0015	$T_j=25^\circ\text{C}$ $T_j=125^\circ\text{C}$	5,2	5,8	6,4	V
Collector-emitter saturation voltage	$V_{CE(sat)}$		15		40	$T_j=25^\circ\text{C}$ $T_j=125^\circ\text{C}$	1,7	1,96 2,29	2,4	V
Collector-emitter cut-off current incl. Diode	I_{CES}		0	1200		$T_j=25^\circ\text{C}$ $T_j=125^\circ\text{C}$			0,005	mA
Gate-emitter leakage current	I_{GES}		20	0		$T_j=25^\circ\text{C}$ $T_j=125^\circ\text{C}$			120	nA
Integrated Gate resistor	R_{gint}							none		Ω
Turn-on delay time	$t_{d(on)}$	Rgoff=8 Ω Rgon=8 Ω	± 15	350	28	$T_j=25^\circ\text{C}$		70		ns
Rise time	t_r					$T_j=125^\circ\text{C}$		72		
Turn-off delay time	$t_{d(off)}$					$T_j=25^\circ\text{C}$		13		
						$T_j=125^\circ\text{C}$		15		
Fall time	t_f					$T_j=25^\circ\text{C}$		166		
						$T_j=125^\circ\text{C}$		217		
Turn-on energy loss per pulse	E_{on}					$T_j=25^\circ\text{C}$ $T_j=125^\circ\text{C}$		0,31 0,52		mWs
Turn-off energy loss per pulse	E_{off}					$T_j=25^\circ\text{C}$ $T_j=125^\circ\text{C}$		0,67 1,16		
Input capacitance	C_{ies}							2300		pF
Output capacitance	C_{oss}	f=1MHz	0	25		$T_j=25^\circ\text{C}$		150		
Reverse transfer capacitance	C_{riss}							135		
Gate charge	Q_{Gate}		± 15	960	40	$T_j=25^\circ\text{C}$		185		nC
Thermal resistance chip to heatsink per chip	R_{thJH}	Thermal grease thickness $\leq 50\mu\text{m}$ $\lambda = 1 \text{ W/mK}$						1,27		K/W
Neutral Point FWD										
Diode forward voltage	V_F				30	$T_j=25^\circ\text{C}$ $T_j=125^\circ\text{C}$		2,28 1,74	2,5	V
Reverse leakage current	I_r			600		$T_j=25^\circ\text{C}$ $T_j=125^\circ\text{C}$			100 500	μA
Peak reverse recovery current	I_{RRM}	Rgoff=8 Ω	± 15	350	28	$T_j=25^\circ\text{C}$		32		A
Reverse recovery time	t_{rr}					$T_j=125^\circ\text{C}$		41		
						$T_j=25^\circ\text{C}$		18		
Reverse recovered charge	Q_{rr}					$T_j=125^\circ\text{C}$		40		
						$T_j=25^\circ\text{C}$		0,32		
Peak rate of fall of recovery current	$di(rec)max/dt$					$T_j=125^\circ\text{C}$		0,92		
		$T_j=25^\circ\text{C}$		8818						
Reverse recovered energy	E_{rec}					$T_j=25^\circ\text{C}$ $T_j=125^\circ\text{C}$		0,03 0,12		mWs
Thermal resistance chip to heatsink per chip	R_{thJH}	Thermal grease thickness $\leq 50\mu\text{m}$ $\lambda = 1 \text{ W/mK}$						2,34		K/W

Characteristic Values

Parameter	Symbol	Conditions					Value			Unit
		V_{GE} [V] or V_{GS} [V]	V_i [V] or V_{CE} [V] or V_{DS} [V]	I_c [A] or I_f [A] or I_b [A]	T_j	Min	Typ	Max		
Neutral Point IGBT										
Gate emitter threshold voltage	$V_{GE(th)}$	$V_{CE}=V_{GE}$				$T_j=25^\circ\text{C}$ $T_j=125^\circ\text{C}$	5	5,80	6,5	V
Collector-emitter saturation voltage	$V_{CE(sat)}$				0,002	$T_j=25^\circ\text{C}$ $T_j=125^\circ\text{C}$	1,1	1,52 1,70	1,9	V
Collector-emitter cut-off incl diode	I_{CES}		15		30	$T_j=25^\circ\text{C}$ $T_i=125^\circ\text{C}$			0,0016	mA
Gate-emitter leakage current	I_{GES}		0	600					300	nA
Integrated Gate resistor	R_{gint}							none		Ω
Turn-on delay time	$t_{d(on)}$	Rgoff=16 Ω Rgon=16 Ω	± 15	350	28	$T_j=25^\circ\text{C}$		105		ns
Rise time	t_r					$T_j=125^\circ\text{C}$		105		
Turn-off delay time	$t_{d(off)}$					$T_j=25^\circ\text{C}$		11		
Fall time	t_f					$T_j=125^\circ\text{C}$		16		
Turn-on energy loss per pulse	E_{on}					$T_j=25^\circ\text{C}$		164		
Turn-off energy loss per pulse	E_{off}					$T_j=125^\circ\text{C}$		187		
Input capacitance	C_{iss}					$T_j=25^\circ\text{C}$		74		
Output capacitance	C_{oss}	f=1MHz	0	25	$T_j=25^\circ\text{C}$	$T_j=25^\circ\text{C}$		0,49		mWs
Reverse transfer capacitance	C_{riss}					$T_j=125^\circ\text{C}$		0,66		
Gate charge	Q_{gate}					$T_j=25^\circ\text{C}$		0,76		
Thermal resistance chip to heatsink per chip	R_{thJH}	Thermal grease thickness $\leq 50\mu\text{m}$ $\lambda = 1 \text{ W/mK}$						2,56		K/W
Half Bridge FWD										
Diode forward voltage	V_F				15	$T_j=25^\circ\text{C}$ $T_j=125^\circ\text{C}$		2,28 2,39	2,71	V
Reverse leakage current	I_r			1200		$T_j=25^\circ\text{C}$ $T_i=125^\circ\text{C}$			60	μA
Peak reverse recovery current	I_{RRM}	Rgoff=16 Ω	± 15	350	28	$T_j=25^\circ\text{C}$		41		A
Reverse recovery time	t_{rr}					$T_j=125^\circ\text{C}$		44		
Reverse recovered charge	Q_{rr}					$T_j=25^\circ\text{C}$		44		
Peak rate of fall of recovery current	$di(rec)_{max}/dt$					$T_j=125^\circ\text{C}$		110		
Reverse recovery energy	E_{rec}					$T_j=25^\circ\text{C}$		1,47		
						$T_j=125^\circ\text{C}$		2,73		
						$T_j=25^\circ\text{C}$		5094		
		$T_j=125^\circ\text{C}$		3534						
		$T_j=25^\circ\text{C}$		0,35						
		$T_j=125^\circ\text{C}$		0,71						
Thermal resistance chip to heatsink per chip	R_{thJH}	Thermal grease thickness $\leq 50\mu\text{m}$ $\lambda = 1 \text{ W/mK}$						3,36		K/W
Thermistor										
Rated resistance	R					$T_j=25^\circ\text{C}$		21511		Ω
Deviation of R25	$\Delta R/R$	R100=1486 Ω				$T_c=100^\circ\text{C}$	-4,5		+4,5	%
Power dissipation	P					$T_j=25^\circ\text{C}$		210		mW
Power dissipation constant						$T_j=25^\circ\text{C}$		3,5		mW/K
B-value	$B_{(25/50)}$					$T_j=25^\circ\text{C}$		3884		K
B-value	$B_{(25/100)}$					$T_j=25^\circ\text{C}$		3964		K
Vincotech NTC Reference						$T_j=25^\circ\text{C}$			F	

Buck

Half Bridge IGBT and Neutral Point FWD

Figure 1 IGBT

Typical output characteristics

$I_C = f(V_{CE})$

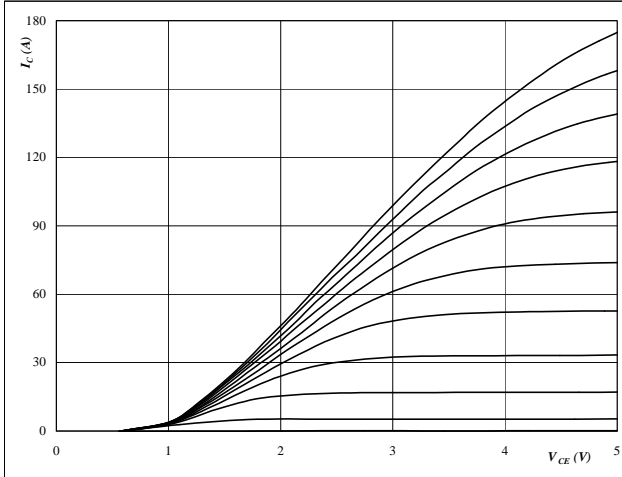

At
 $t_p = 250 \mu s$
 $T_j = 25 \text{ }^\circ C$
 V_{GE} from 7 V to 17 V in steps of 1 V

Figure 2 IGBT

Typical output characteristics

$I_C = f(V_{CE})$

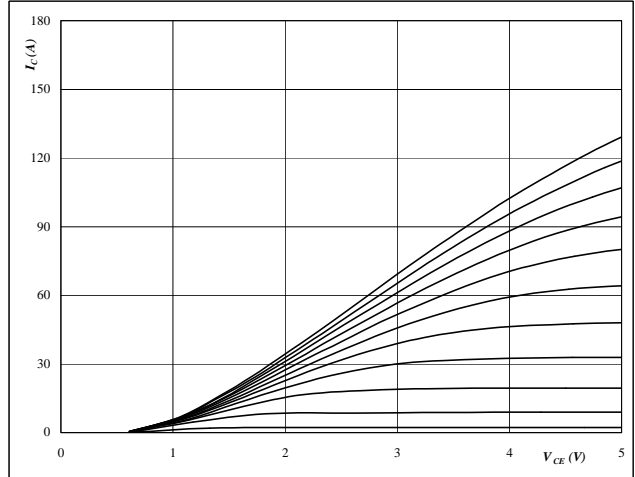

At
 $t_p = 250 \mu s$
 $T_j = 125 \text{ }^\circ C$
 V_{GE} from 7 V to 17 V in steps of 1 V

Figure 3 IGBT

Typical transfer characteristics

$I_C = f(V_{GE})$

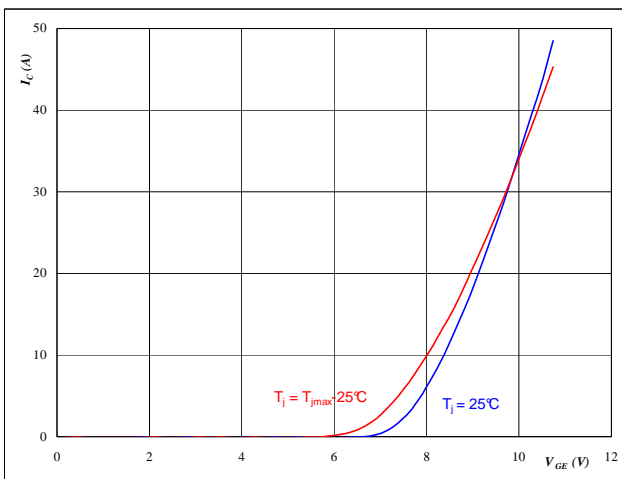

At
 $t_p = 250 \mu s$
 $V_{CE} = 10 V$

Figure 4 FWD

Typical diode forward current as a function of forward voltage

$I_F = f(V_F)$

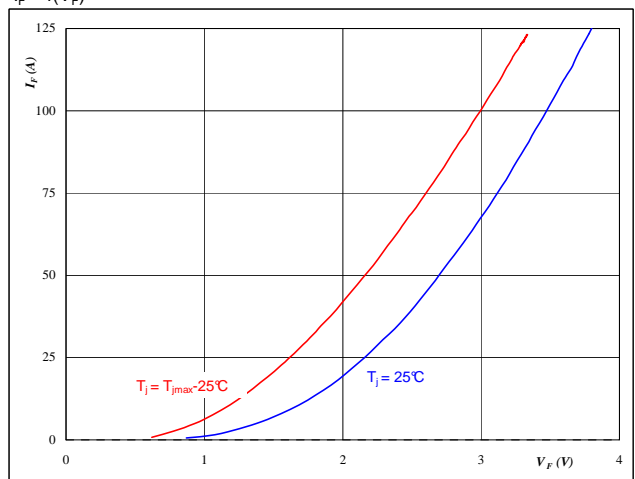

At
 $t_p = 250 \mu s$

Buck

Half Bridge IGBT and Neutral Point FWD

Figure 5 IGBT

Typical switching energy losses
as a function of collector current

$$E = f(I_C)$$

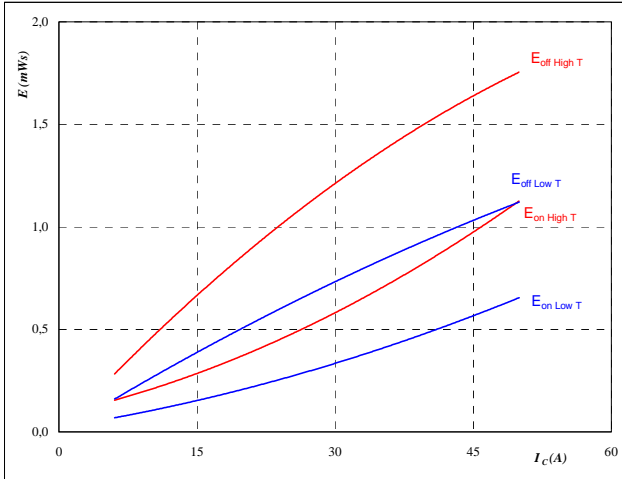

With an inductive load at

$T_J =$	25/125	°C
$V_{CE} =$	350	V
$V_{GE} =$	±15	V
$R_{gon} =$	8	Ω
$R_{goff} =$	8	Ω

Figure 6 IGBT

Typical switching energy losses
as a function of gate resistor

$$E = f(R_G)$$

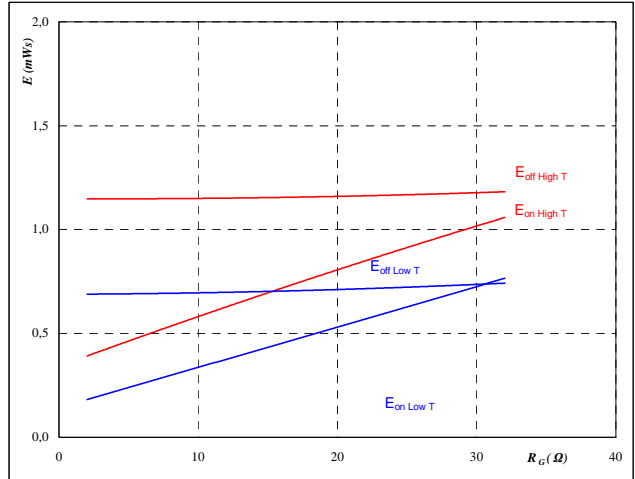

With an inductive load at

$T_J =$	25/125	°C
$V_{CE} =$	350	V
$V_{GE} =$	±15	V
$I_C =$	28	A

Figure 7 FWD

Typical reverse recovery energy loss
as a function of collector current

$$E_{rec} = f(I_C)$$

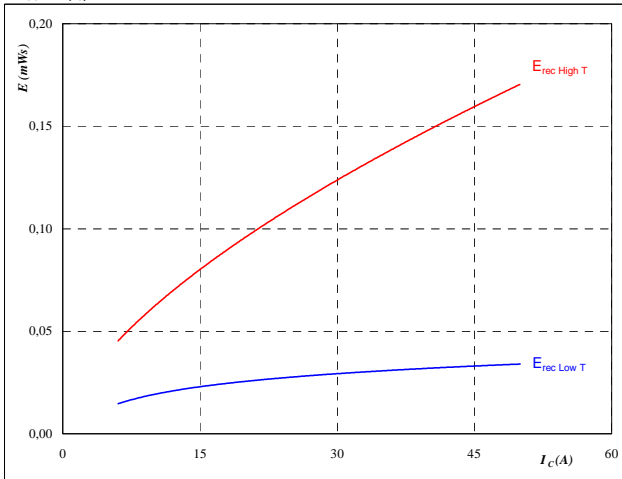

With an inductive load at

$T_J =$	25/125	°C
$V_{CE} =$	350	V
$V_{GE} =$	±15	V
$R_{gon} =$	8	Ω

Figure 8 FWD

Typical reverse recovery energy loss
as a function of gate resistor

$$E_{rec} = f(R_G)$$

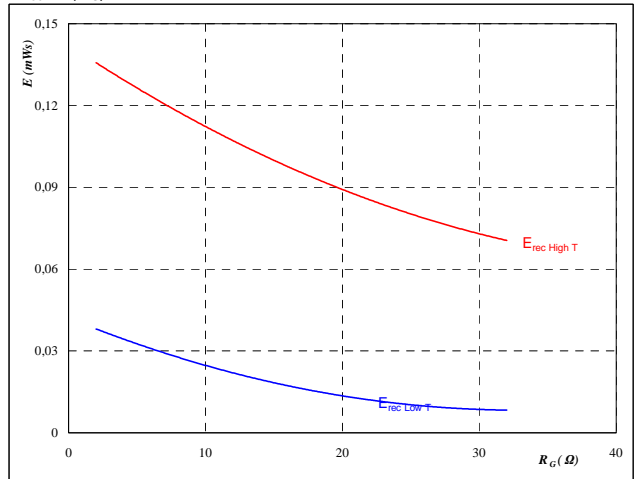

With an inductive load at

$T_J =$	25/125	°C
$V_{CE} =$	350	V
$V_{GE} =$	±15	V
$I_C =$	28	A

Buck

Half Bridge IGBT and Neutral Point FWD

Figure 9 IGBT

Typical switching times as a function of collector current

$$t = f(I_C)$$

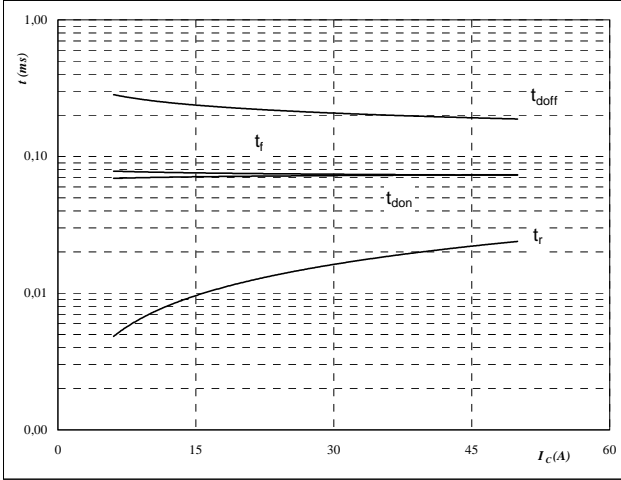

With an inductive load at

$T_J =$	125	°C
$V_{CE} =$	350	V
$V_{GE} =$	±15	V
$R_{gon} =$	8	Ω
$R_{goff} =$	8	Ω

Figure 10 IGBT

Typical switching times as a function of gate resistor

$$t = f(R_G)$$

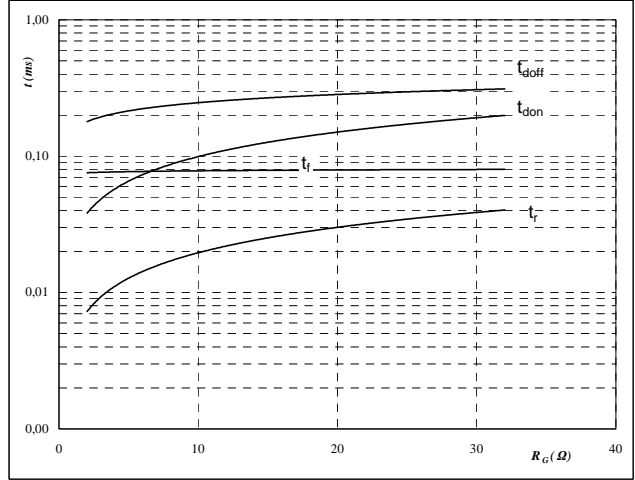

With an inductive load at

$T_J =$	125	°C
$V_{CE} =$	350	V
$V_{GE} =$	±15	V
$I_C =$	28	A

Figure 11 FWD

Typical reverse recovery time as a function of collector current

$$t_{rr} = f(I_C)$$

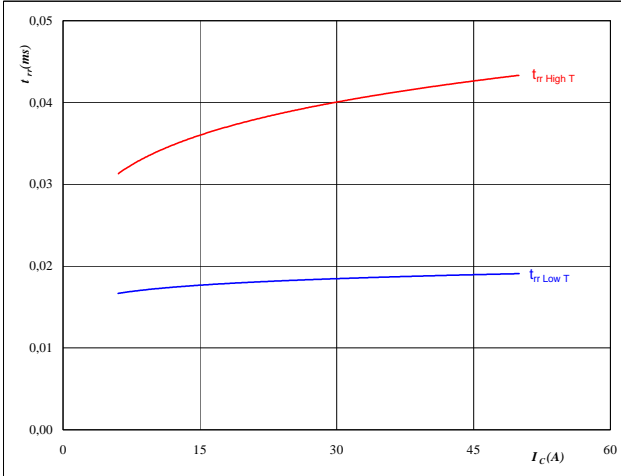

At

$T_J =$	25/125	°C
$V_{CE} =$	350	V
$V_{GE} =$	±15	V
$R_{gon} =$	8	Ω

Figure 12 FWD

Typical reverse recovery time as a function of IGBT turn on gate resistor

$$t_{rr} = f(R_{gon})$$

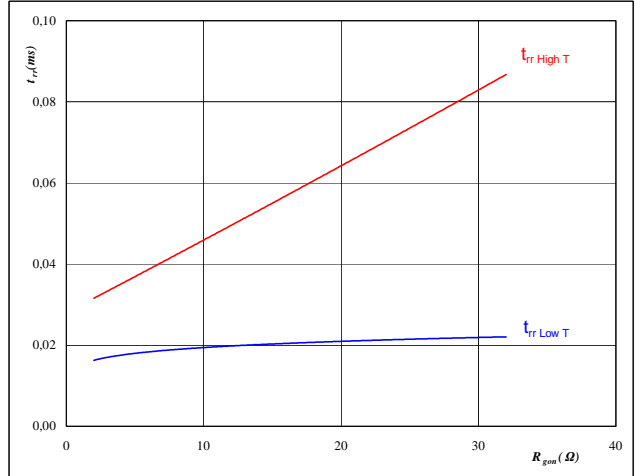

At

$T_J =$	25/125	°C
$V_R =$	350	V
$I_F =$	28	A
$V_{GE} =$	±15	V

Buck

Half Bridge IGBT and Neutral Point FWD

Figure 13 FWD

Typical reverse recovery charge as a function of collector current

$$Q_{rr} = f(I_C)$$

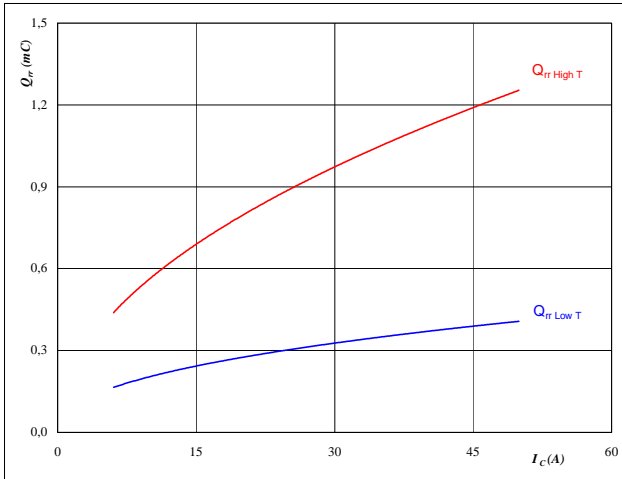

At
 $T_j = 25/125$ °C
 $V_{CE} = 350$ V
 $V_{GE} = \pm 15$ V
 $R_{gon} = 8$ Ω

Figure 14 FWD

Typical reverse recovery charge as a function of IGBT turn on gate resistor

$$Q_{rr} = f(R_{gon})$$

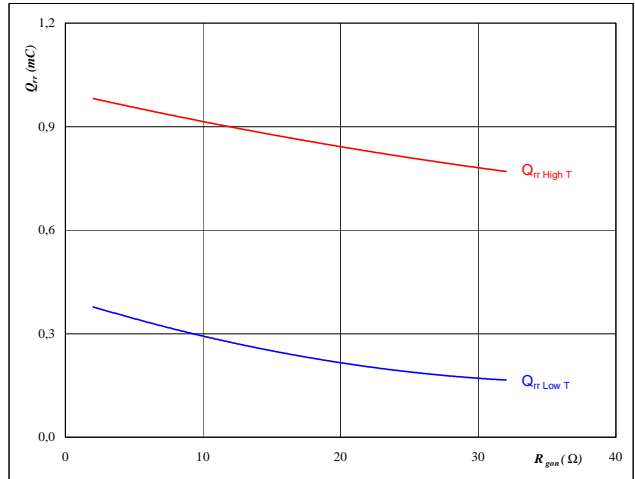

At
 $T_j = 25/125$ °C
 $V_R = 350$ V
 $I_F = 28$ A
 $V_{GE} = \pm 15$ V

Figure 15 FWD

Typical reverse recovery current as a function of collector current

$$I_{RRM} = f(I_C)$$

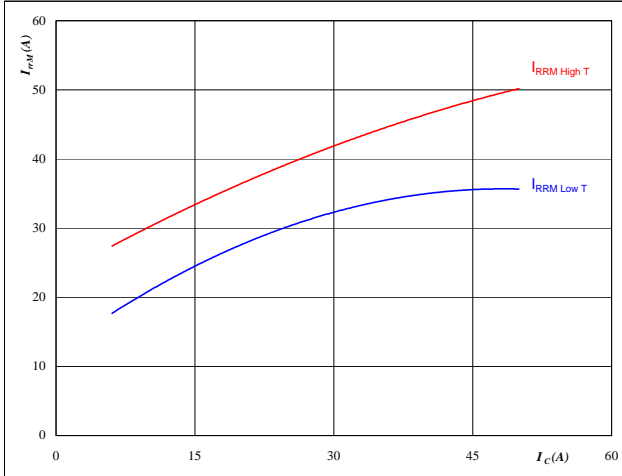

At
 $T_j = 25/125$ °C
 $V_{CE} = 350$ V
 $V_{GE} = \pm 15$ V
 $R_{gon} = 8$ Ω

Figure 16 FWD

Typical reverse recovery current as a function of IGBT turn on gate resistor

$$I_{RRM} = f(R_{gon})$$

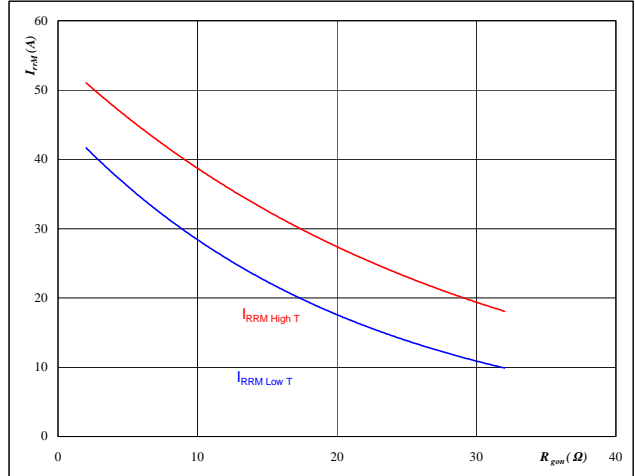

At
 $T_j = 25/125$ °C
 $V_R = 350$ V
 $I_F = 28$ A
 $V_{GE} = \pm 15$ V

Buck

Half Bridge IGBT and Neutral Point FWD

Figure 17 FWD

Typical rate of fall of forward and reverse recovery current as a function of collector current

$$di_o/dt, di_{rec}/dt = f(I_c)$$

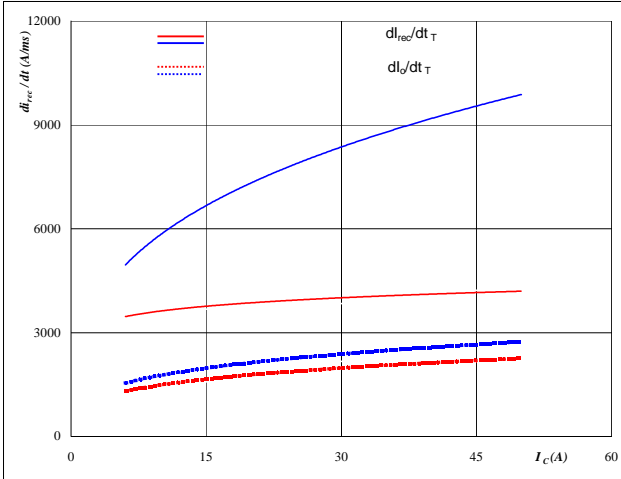

At
 $T_j = 25/125 \text{ } ^\circ\text{C}$
 $V_{CE} = 350 \text{ V}$
 $V_{GE} = \pm 15 \text{ V}$
 $R_{gon} = 8 \text{ } \Omega$

Figure 18 FWD

Typical rate of fall of forward and reverse recovery current as a function of IGBT turn on gate resistor

$$di_o/dt, di_{rec}/dt = f(R_{gon})$$

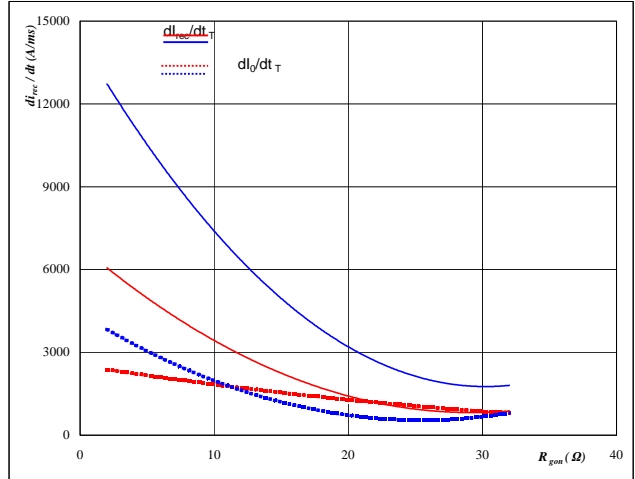

At
 $T_j = 25/125 \text{ } ^\circ\text{C}$
 $V_R = 350 \text{ V}$
 $I_F = 28 \text{ A}$
 $V_{GE} = \pm 15 \text{ V}$

Figure 19 IGBT

IGBT transient thermal impedance as a function of pulse width

$$Z_{thJH} = f(t_p)$$

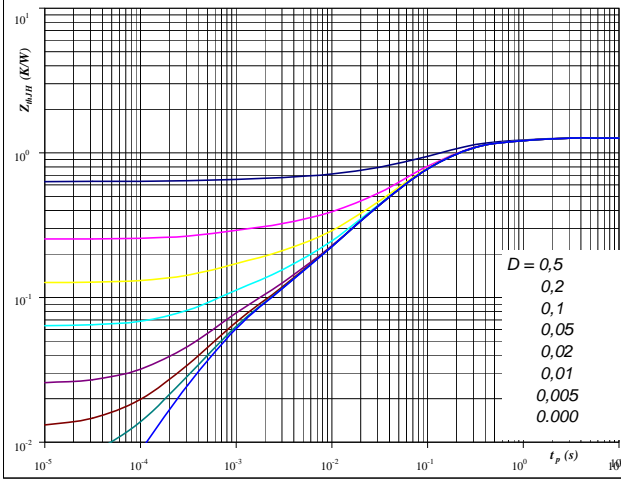

At
 $D = t_p / T$
 $R_{thJH} = 1,27 \text{ K/W}$

IGBT thermal model values

R (C/W)	Tau (s)
0,18	8,2E-01
0,64	1,3E-01
0,30	4,8E-02
0,10	9,3E-03
0,06	8,0E-04

Figure 20 FWD

FWD transient thermal impedance as a function of pulse width

$$Z_{thJH} = f(t_p)$$

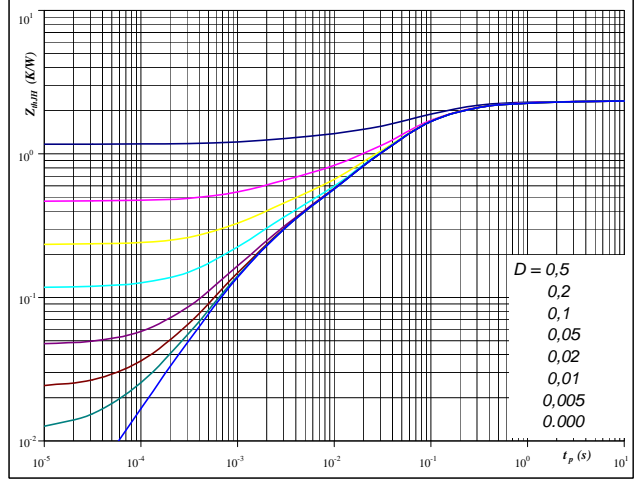

At
 $D = t_p / T$
 $R_{thJH} = 2,34 \text{ K/W}$

FWD thermal model values

R (C/W)	Tau (s)
0,11	2,4E+00
0,36	3,0E-01
1,41	6,5E-02
0,28	1,1E-02
0,19	1,6E-03

Buck

Half Bridge IGBT and Neutral Point FWD

Figure 21 IGBT

Power dissipation as a function of heatsink temperature

$$P_{tot} = f(T_h)$$

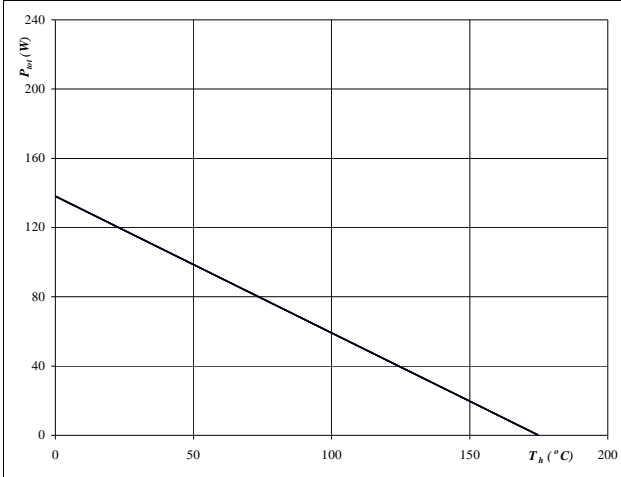

At
 $T_j = 175$ °C

Figure 22 IGBT

Collector current as a function of heatsink temperature

$$I_C = f(T_h)$$

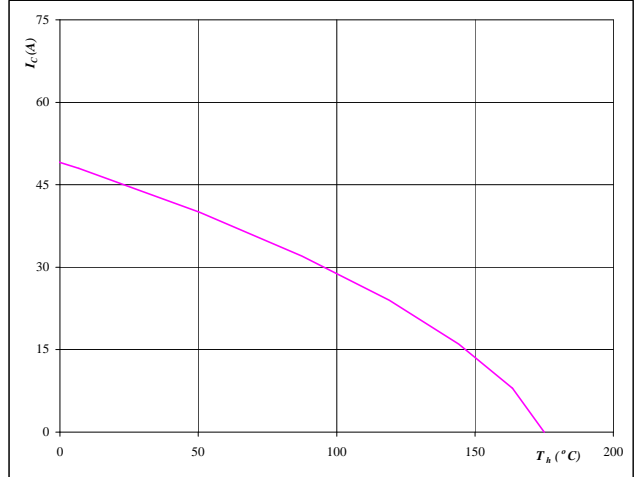

At
 $T_j = 175$ °C
 $V_{GE} = 15$ V

Figure 23 FWD

Power dissipation as a function of heatsink temperature

$$P_{tot} = f(T_h)$$

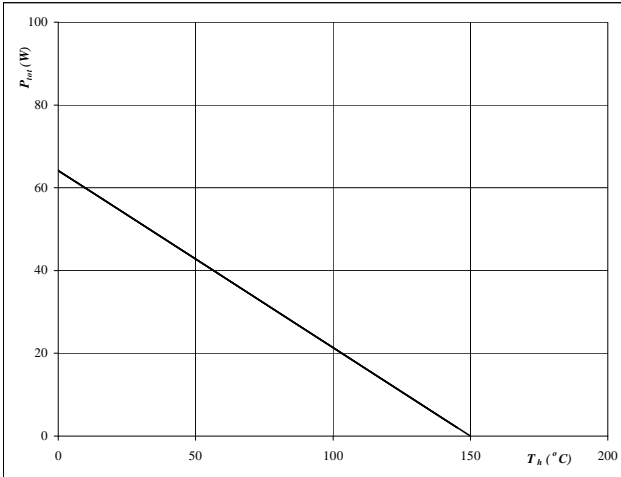

At
 $T_j = 150$ °C

Figure 24 FWD

Forward current as a function of heatsink temperature

$$I_F = f(T_h)$$

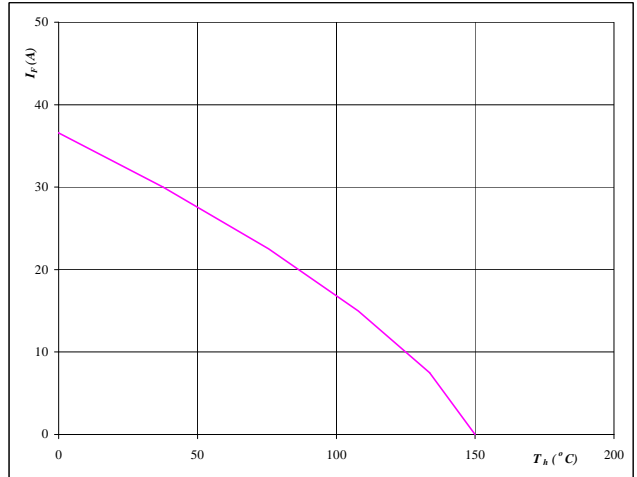

At
 $T_j = 150$ °C

Buck

Half Bridge IGBT and Neutral Point FWD

Figure 25 IGBT

Safe operating area as a function of collector-emitter voltage

$$I_C = f(V_{CE})$$

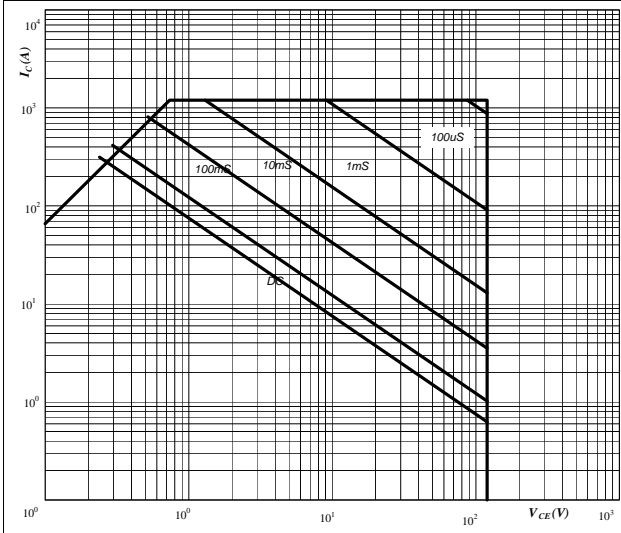

At
 D = single pulse
 Th = 80 °C
 V_{GE} = ±15 V
 T_j = T_{jmax} °C

Figure 26 IGBT

Gate voltage vs Gate charge

$$V_{GE} = f(Q_g)$$

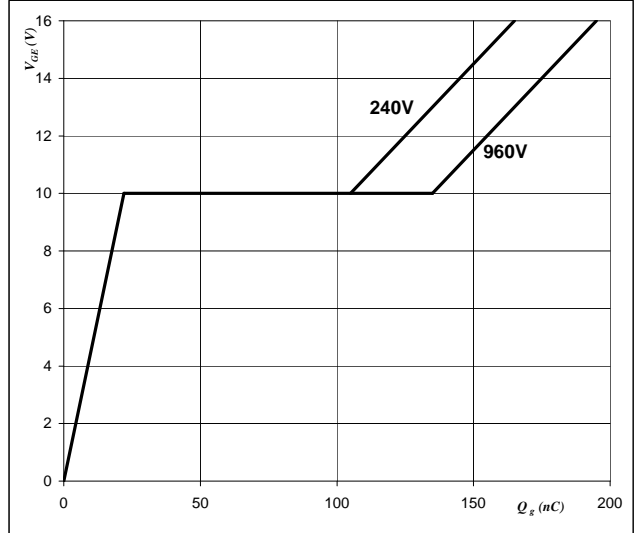

At
 I_C = 40 A

Figure 27 IGBT

Reverse bias safe operating area

$$I_C = f(V_{CE})$$

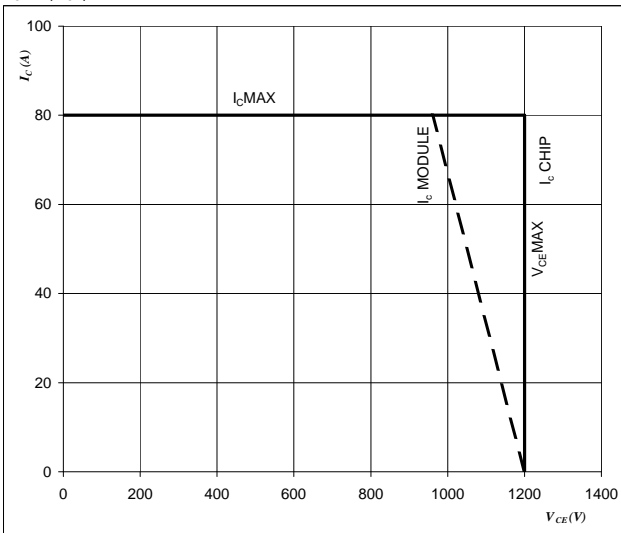

At
 T_j = T_{jmax}-25 °C
 DC link_{minus}=DC link_{plus}
 Switching mode : 3 level switching

Boost

Neutral Point IGBT and Half Bridge FWD

Figure 1 IGBT

Typical output characteristics

$I_C = f(V_{CE})$



At
 $t_p = 250 \mu s$
 $T_j = 25 \text{ }^\circ C$
 V_{GE} from 7 V to 17 V in steps of 1 V

Figure 2 IGBT

Typical output characteristics

$I_C = f(V_{CE})$

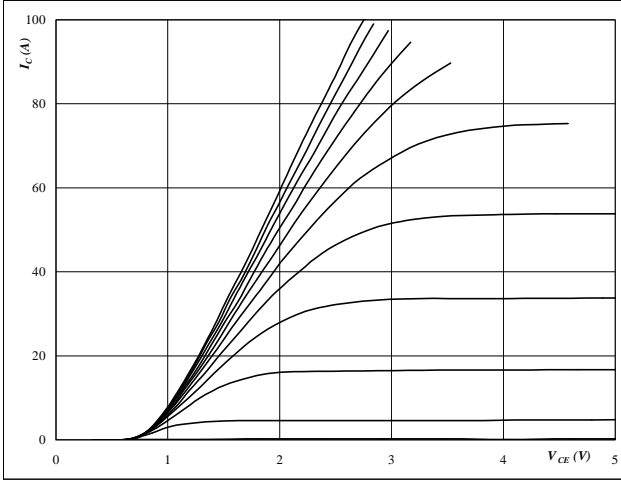

At
 $t_p = 250 \mu s$
 $T_j = 125 \text{ }^\circ C$
 V_{GE} from 7 V to 17 V in steps of 1 V

Figure 3 IGBT

Typical transfer characteristics

$I_C = f(V_{GE})$

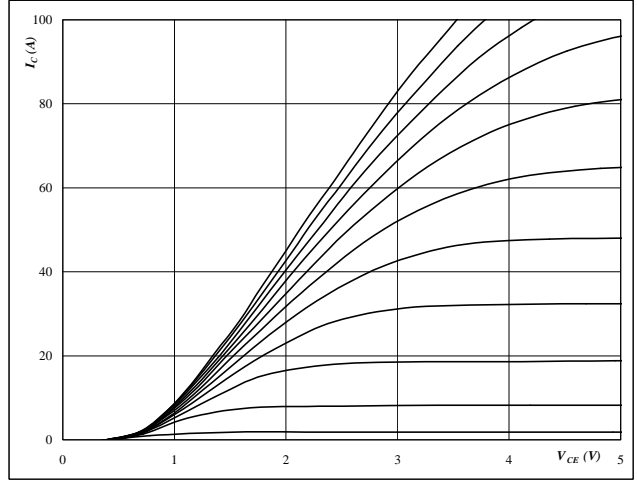
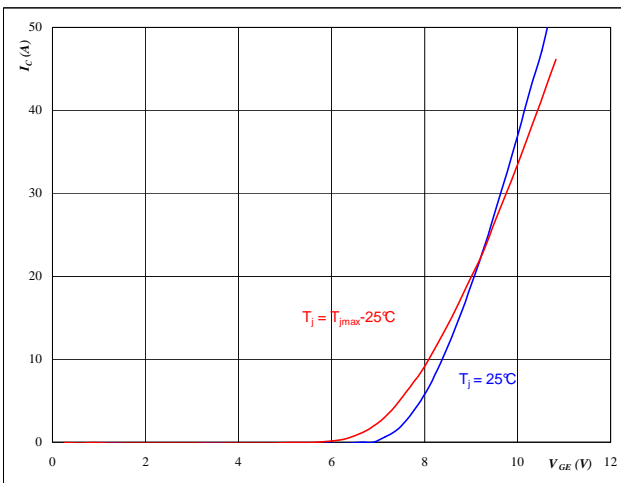
At
 $t_p = 250 \mu s$
 $V_{CE} = 10 \text{ V}$
Figure 4 FWD

Typical diode forward current as a function of forward voltage

$I_F = f(V_F)$

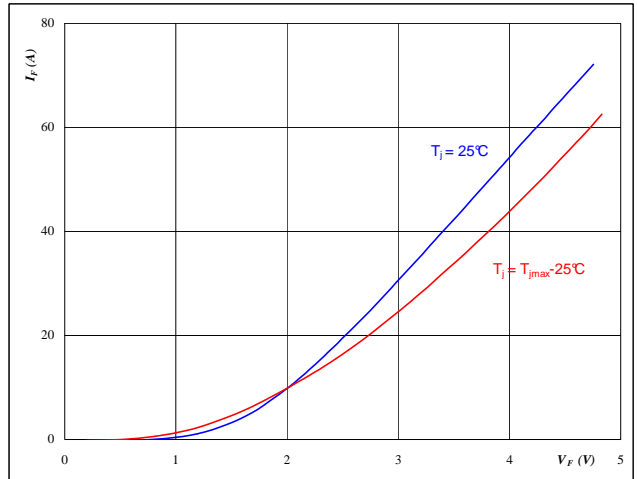
At
 $t_p = 250 \mu s$

Boost

Neutral Point IGBT and Half Bridge FWD

Figure 5 IGBT

Typical switching energy losses
as a function of collector current

$$E = f(I_C)$$

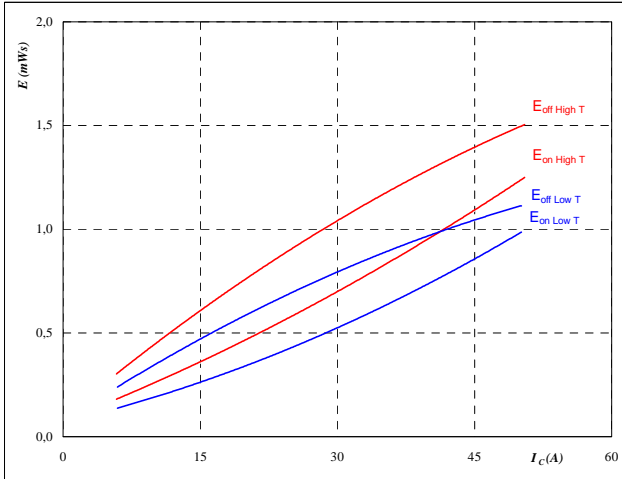

With an inductive load at

$T_J =$	25/125	°C
$V_{CE} =$	350	V
$V_{GE} =$	±15	V
$R_{gon} =$	16	Ω
$R_{goff} =$	16	Ω

Figure 6 IGBT

Typical switching energy losses
as a function of gate resistor

$$E = f(R_G)$$

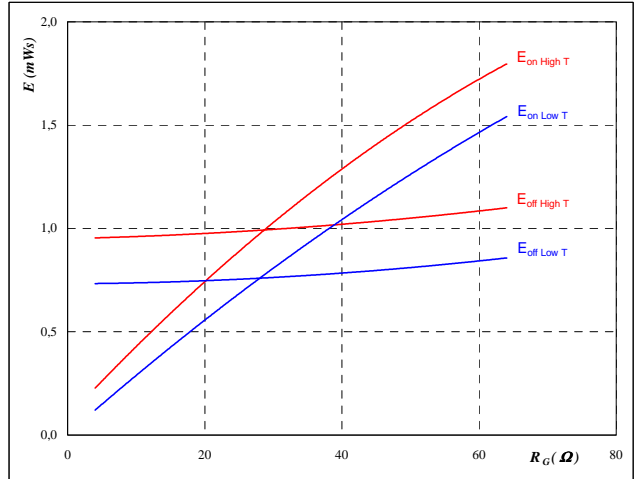

With an inductive load at

$T_J =$	25/125	°C
$V_{CE} =$	350	V
$V_{GE} =$	±15	V
$I_C =$	28	A

Figure 7 FWD

Typical reverse recovery energy loss
as a function of collector current

$$E_{rec} = f(I_C)$$

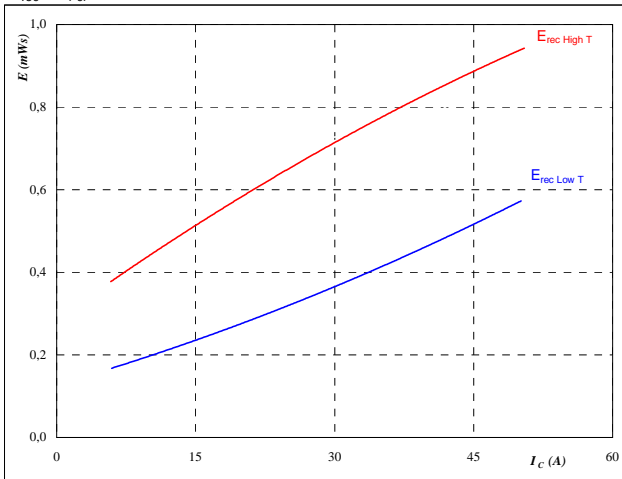

With an inductive load at

$T_J =$	25/125	°C
$V_{CE} =$	350	V
$V_{GE} =$	±15	V
$R_{gon} =$	16	Ω

Figure 8 FWD

Typical reverse recovery energy loss
as a function of gate resistor

$$E_{rec} = f(R_G)$$

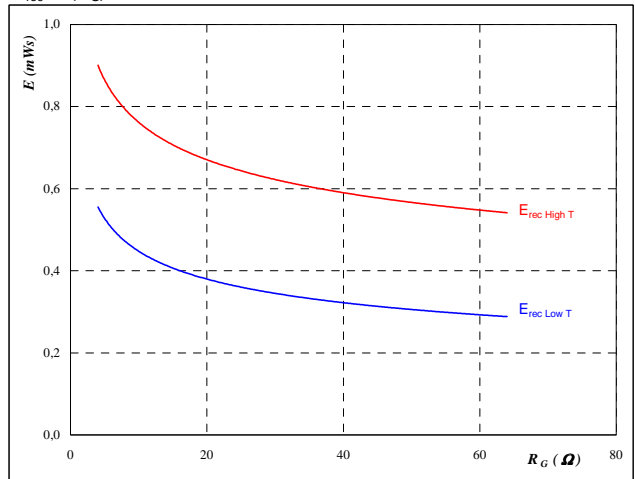

With an inductive load at

$T_J =$	25/125	°C
$V_{CE} =$	350	V
$V_{GE} =$	±15	V
$I_C =$	28	A

Boost

Neutral Point IGBT and Half Bridge FWD

Figure 9 IGBT

Typical switching times as a function of collector current

$$t = f(I_C)$$

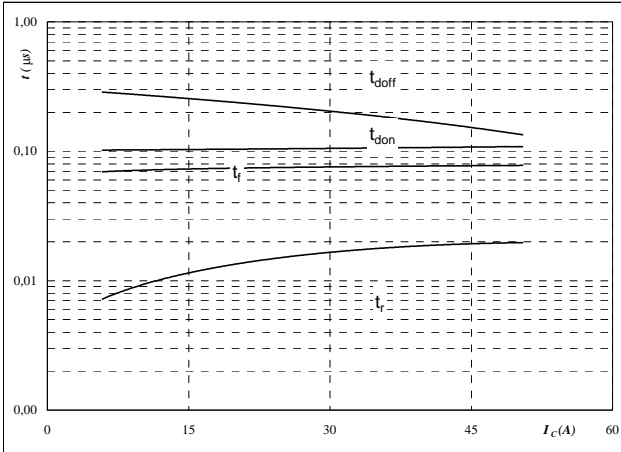

With an inductive load at

$T_j =$	125	°C
$V_{CE} =$	350	V
$V_{GE} =$	±15	V
$R_{gon} =$	16	Ω
$R_{goff} =$	16	Ω

Figure 10 IGBT

Typical switching times as a function of gate resistor

$$t = f(R_G)$$

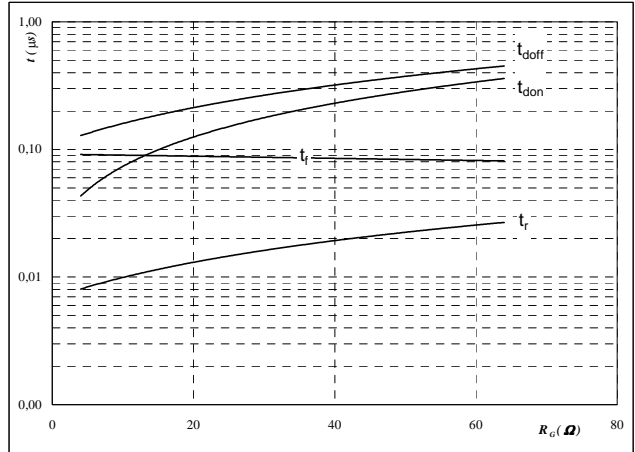

With an inductive load at

$T_j =$	125	°C
$V_{CE} =$	350	V
$V_{GE} =$	±15	V
$I_C =$	28	A

Figure 11 FWD

Typical reverse recovery time as a function of collector current

$$t_{rr} = f(I_C)$$

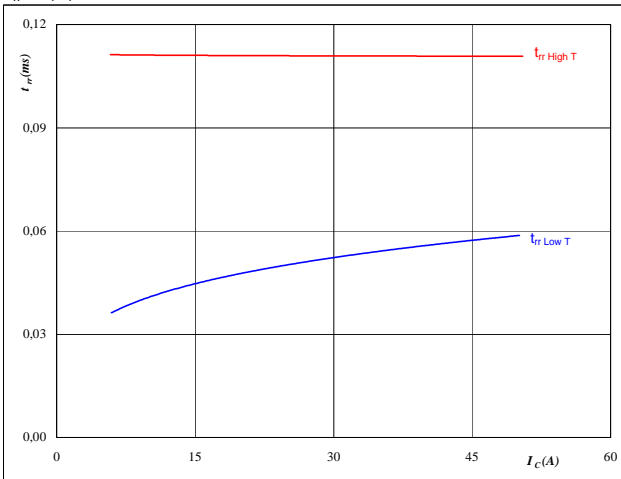

At

$T_j =$	25/125	°C
$V_{CE} =$	350	V
$V_{GE} =$	±15	V
$R_{gon} =$	16	Ω

Figure 12 FWD

Typical reverse recovery time as a function of IGBT turn on gate resistor

$$t_{rr} = f(R_{gon})$$

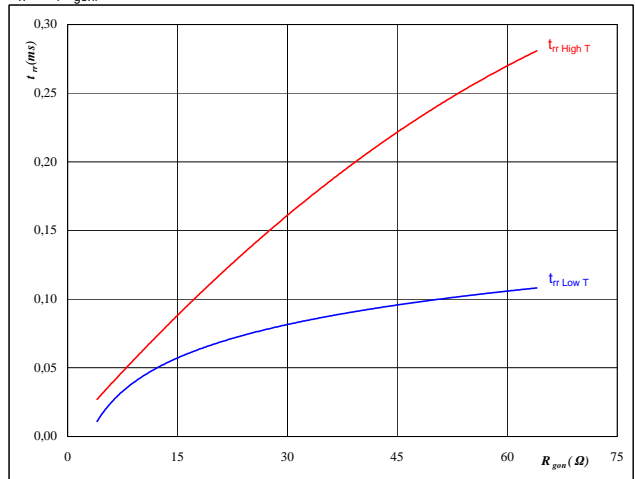

At

$T_j =$	25/125	°C
$V_R =$	350	V
$I_F =$	28	A
$V_{GE} =$	±15	V

Boost

Neutral Point IGBT and Half Bridge FWD

Figure 13 FWD

Typical reverse recovery charge as a function of collector current

$$Q_{rr} = f(I_C)$$

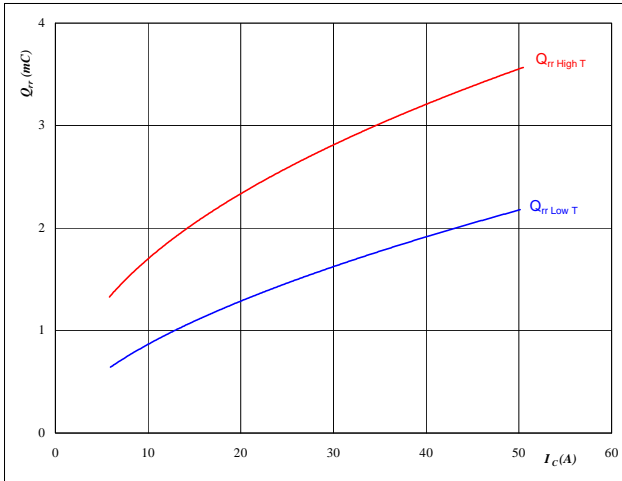

At

$T_j =$	25/125	°C
$V_{CE} =$	350	V
$V_{GE} =$	±15	V
$R_{gon} =$	16	Ω

Figure 14 FWD

Typical reverse recovery charge as a function of IGBT turn on gate resistor

$$Q_{rr} = f(R_{gon})$$

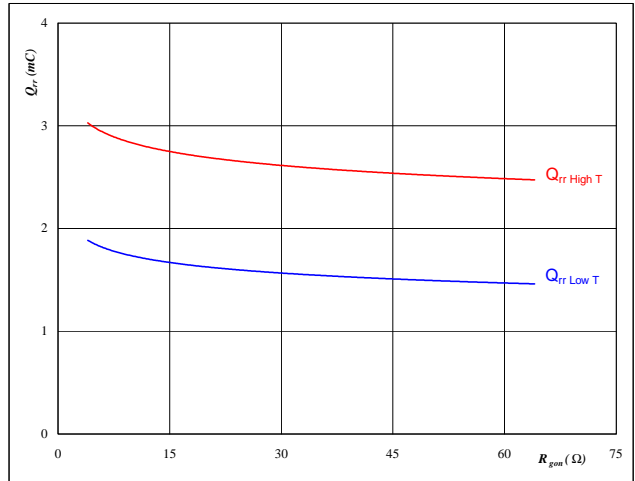

At

$T_j =$	25/125	°C
$V_R =$	350	V
$I_F =$	28	A
$V_{GE} =$	±15	V

Figure 15 FWD

Typical reverse recovery current as a function of collector current

$$I_{RRM} = f(I_C)$$

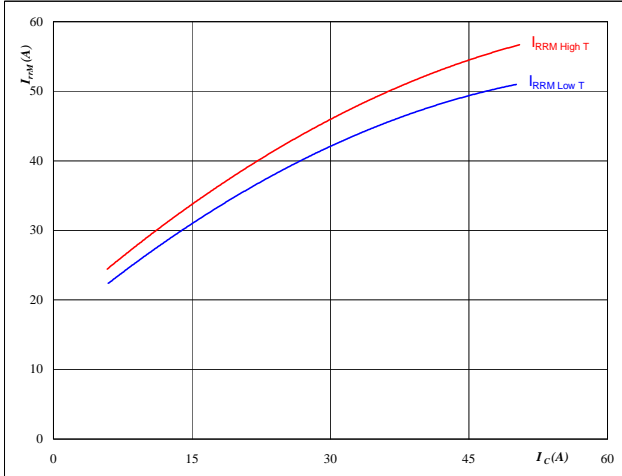

At

$T_j =$	25/125	°C
$V_{CE} =$	350	V
$V_{GE} =$	±15	V
$R_{gon} =$	16	Ω

Figure 16 FWD

Typical reverse recovery current as a function of IGBT turn on gate resistor

$$I_{RRM} = f(R_{gon})$$

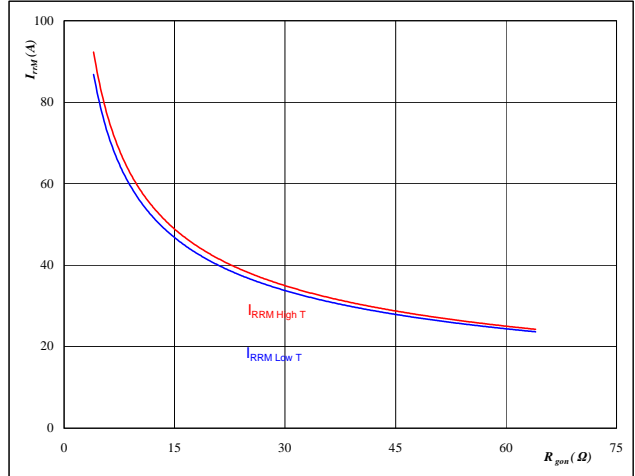

At

$T_j =$	25/125	°C
$V_R =$	350	V
$I_F =$	28	A
$V_{GE} =$	±15	V

Boost

Neutral Point IGBT and Half Bridge FWD

Figure 17 FWD

Typical rate of fall of forward and reverse recovery current as a function of collector current

$$di_o/dt, di_{rec}/dt = f(I_c)$$

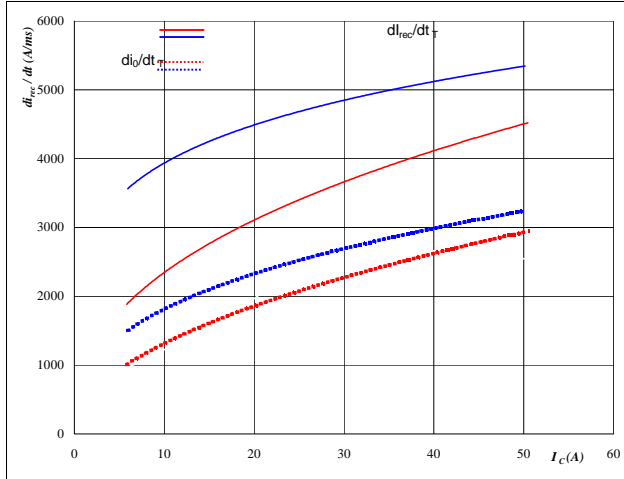

At
 $T_j = 25/125 \text{ } ^\circ\text{C}$
 $V_{CE} = 350 \text{ V}$
 $V_{GE} = \pm 15 \text{ V}$
 $R_{gon} = 16 \text{ } \Omega$

Figure 18 FWD

Typical rate of fall of forward and reverse recovery current as a function of IGBT turn on gate resistor

$$di_o/dt, di_{rec}/dt = f(R_{gon})$$

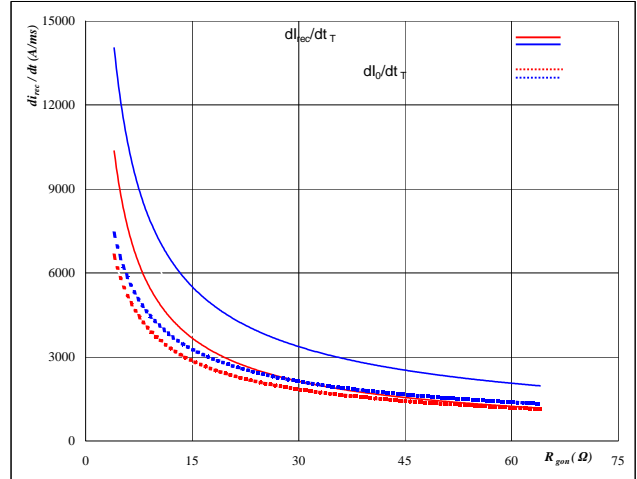

At
 $T_j = 25/125 \text{ } ^\circ\text{C}$
 $V_R = 350 \text{ V}$
 $I_F = 28 \text{ A}$
 $V_{GE} = \pm 15 \text{ V}$

Figure 19 IGBT

IGBT transient thermal impedance as a function of pulse width

$$Z_{thJH} = f(t_p)$$

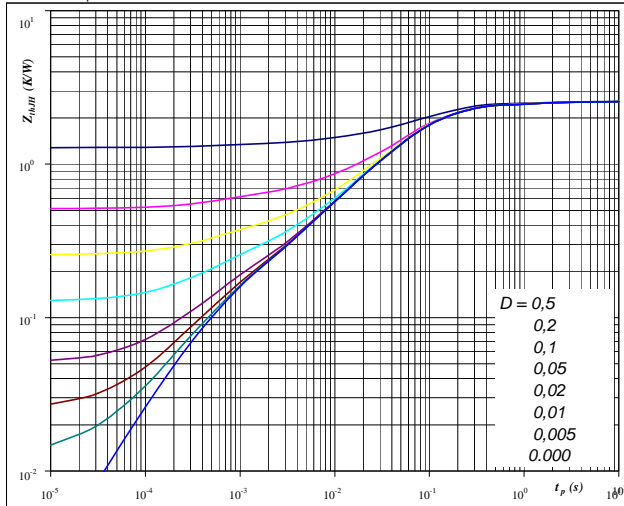

At
 $D = t_p / T$
 $R_{thJH} = 2,56 \text{ K/W}$

IGBT thermal model values

R (C/W)	Tau (s)
0,10	3,0E+00
0,25	4,8E-01
1,64	7,9E-02
0,32	1,9E-02
0,15	4,2E-03
0,11	5,1E-04

Figure 20 FWD

FWD transient thermal impedance as a function of pulse width

$$Z_{thJH} = f(t_p)$$

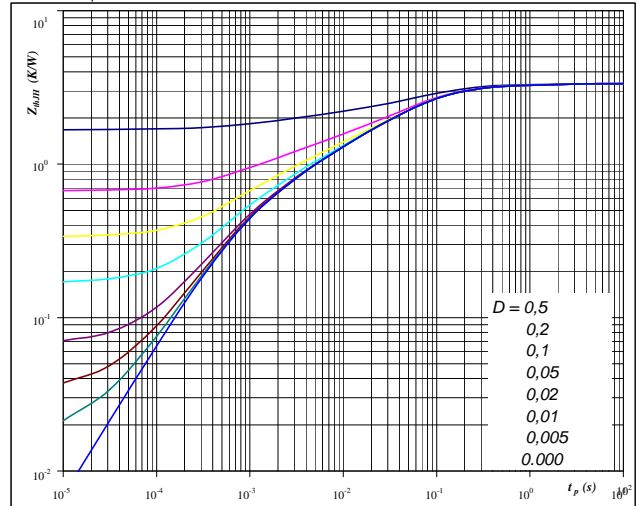

At
 $D = t_p / T$
 $R_{thJH} = 3,36 \text{ K/W}$

FWD thermal model values

R (C/W)	Tau (s)
0,11	2,6E+00
0,25	3,8E-01
1,48	7,2E-02
0,67	1,8E-02
0,50	3,4E-03
0,34	7,0E-04

Boost

Neutral Point IGBT and Half Bridge FWD

Figure 21 IGBT

Power dissipation as a function of heatsink temperature

$$P_{tot} = f(T_h)$$

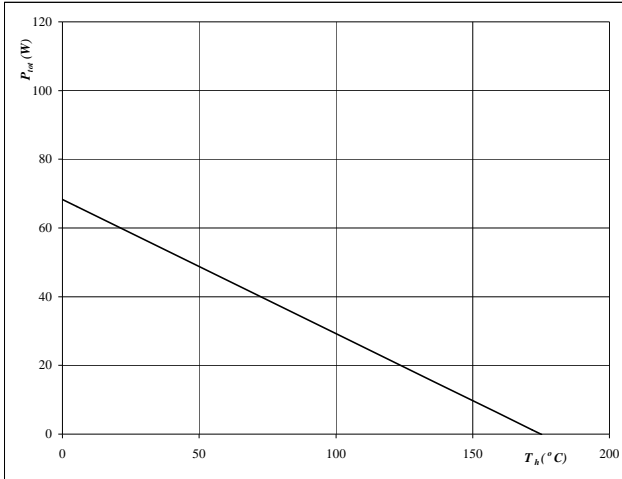

At
 $T_j = 175$ °C

Figure 22 IGBT

Collector current as a function of heatsink temperature

$$I_C = f(T_h)$$

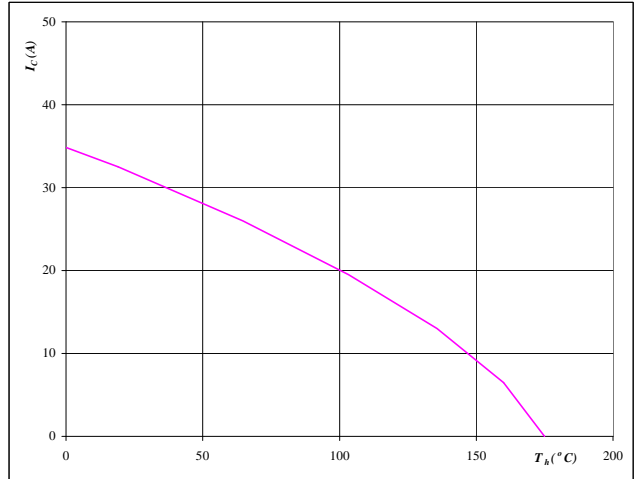

At
 $T_j = 175$ °C
 $V_{GE} = 15$ V

Figure 23 FWD

Power dissipation as a function of heatsink temperature

$$P_{tot} = f(T_h)$$

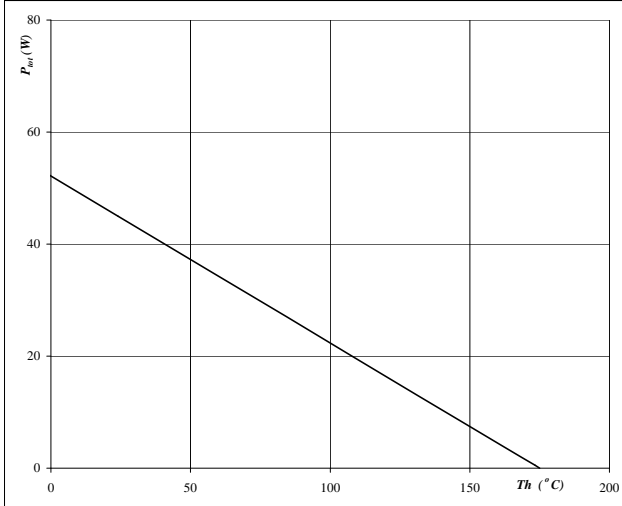

At
 $T_j = 175$ °C

Figure 24 FWD

Forward current as a function of heatsink temperature

$$I_F = f(T_h)$$

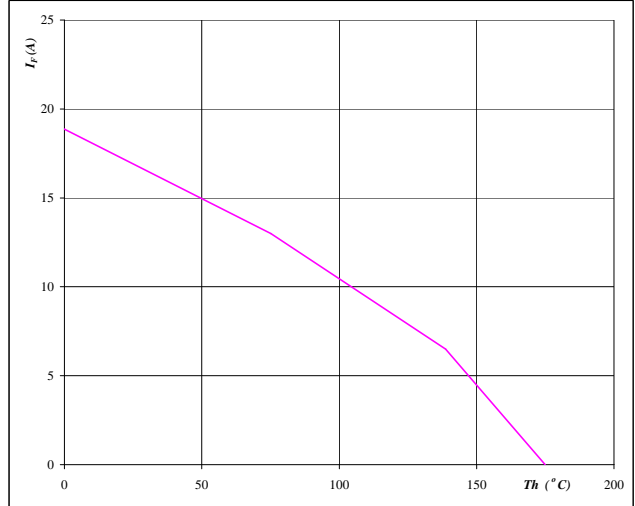

At
 $T_j = 175$ °C

Thermistor

Figure 1 Thermistor

**Typical NTC characteristic
as a function of temperature**

$$R_T = f(T)$$

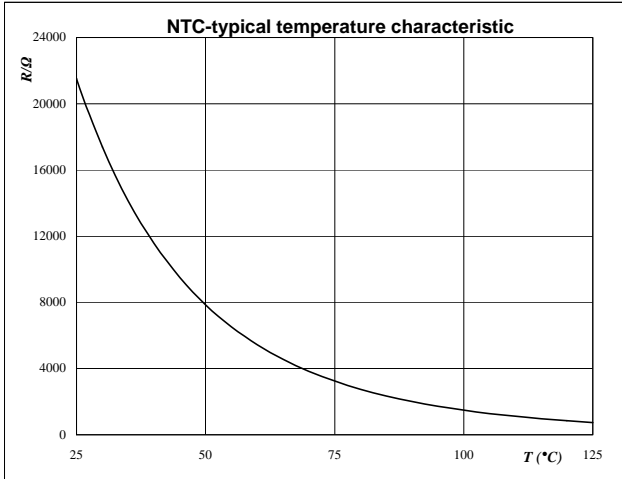

Switching Definitions Neutral Point

General conditions	
T_j	= 125 °C
R_{gon}	= 16 Ω
R_{goff}	= 16 Ω

Figure 1 Boost IGBT

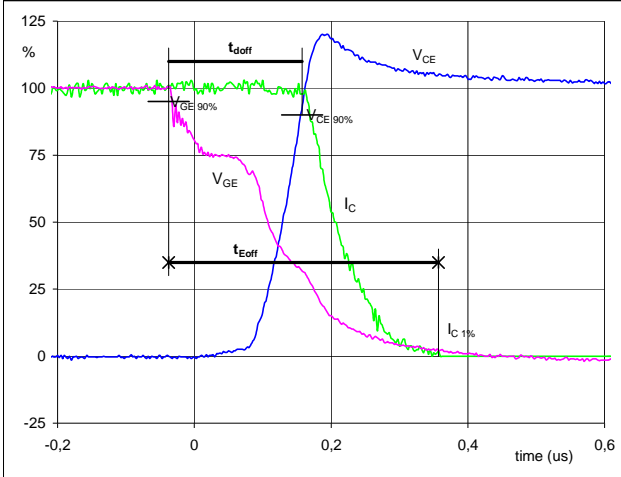
Turn-off Switching Waveforms & definition of t_{doff} , t_{Eoff}
(t_{Eoff} = integrating time for E_{off})

$V_{GE}(0\%) =$	-15	V
$V_{GE}(100\%) =$	15	V
$V_C(100\%) =$	350	V
$I_C(100\%) =$	28	A
$t_{doff} =$	0,19	μs
$t_{Eoff} =$	0,39	μs

Figure 2 Boost IGBT

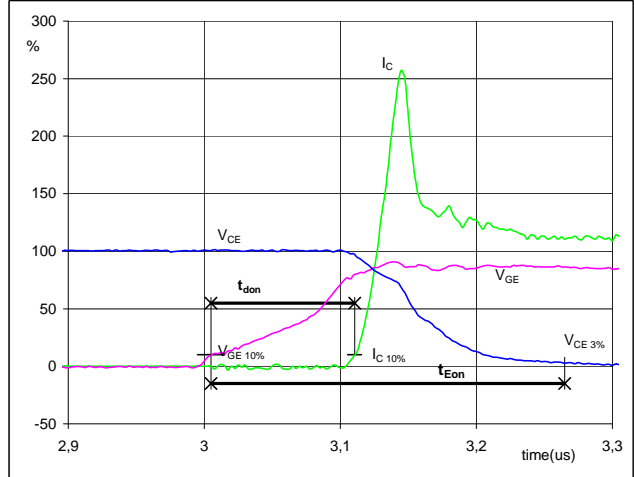
Turn-on Switching Waveforms & definition of t_{don} , t_{Eon}
(t_{Eon} = integrating time for E_{on})

$V_{GE}(0\%) =$	-15	V
$V_{GE}(100\%) =$	15	V
$V_C(100\%) =$	350	V
$I_C(100\%) =$	28	A
$t_{don} =$	0,11	μs
$t_{Eon} =$	0,26	μs

Figure 3 Boost IGBT

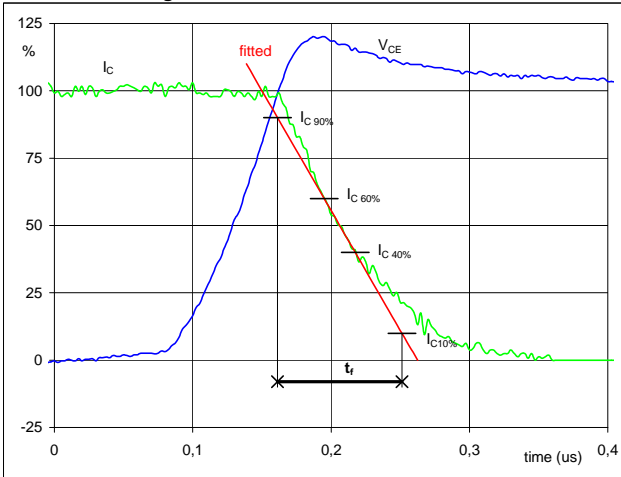
Turn-off Switching Waveforms & definition of t_f

$V_C(100\%) =$	350	V
$I_C(100\%) =$	28	A
$t_f =$	0,09	μs

Figure 4 Boost IGBT

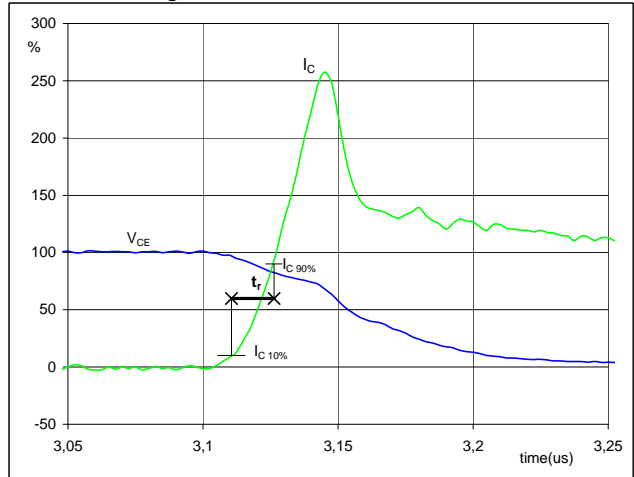
Turn-on Switching Waveforms & definition of t_r

$V_C(100\%) =$	350	V
$I_C(100\%) =$	28	A
$t_r =$	0,02	μs

Switching Definitions Neutral Point

Figure 5 Boost IGBT

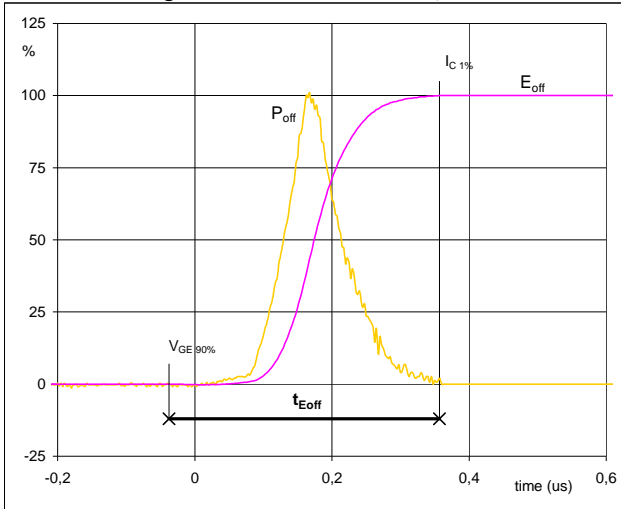
Turn-off Switching Waveforms & definition of t_{Eoff}

$P_{off} (100\%) = 9,70 \text{ kW}$
 $E_{off} (100\%) = 0,98 \text{ mJ}$
 $t_{Eoff} = 0,39 \text{ }\mu\text{s}$

Figure 6 Boost IGBT

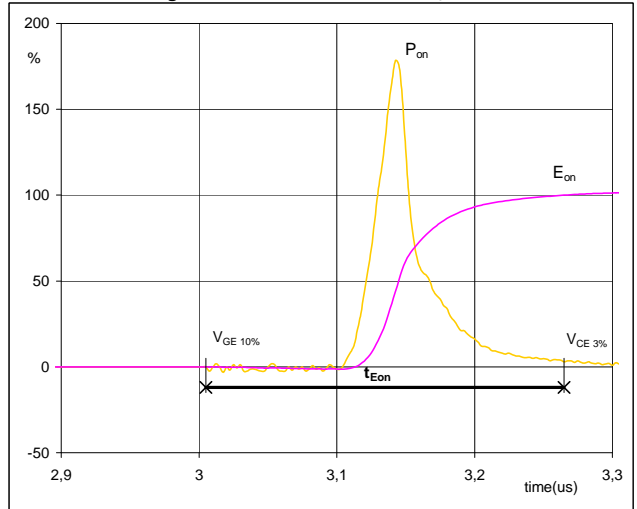
Turn-on Switching Waveforms & definition of t_{Eon}

$P_{on} (100\%) = 9,70 \text{ kW}$
 $E_{on} (100\%) = 0,66 \text{ mJ}$
 $t_{Eon} = 0,26 \text{ }\mu\text{s}$

Figure 7 Boost IGBT

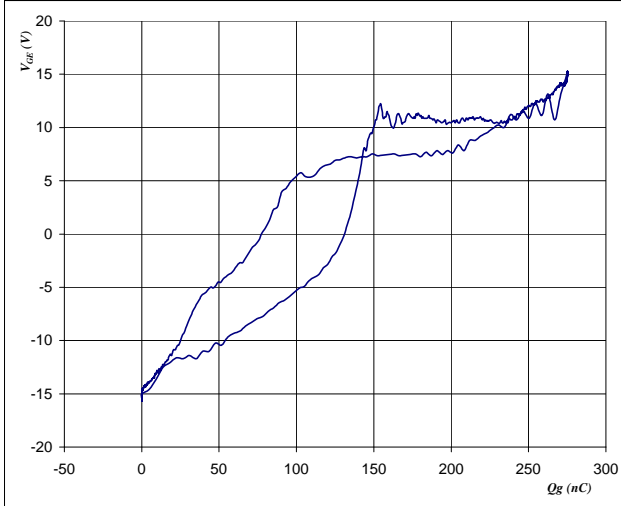
Gate voltage vs Gate charge (measured)

$V_{GEoff} = -15 \text{ V}$
 $V_{GEon} = 15 \text{ V}$
 $V_C (100\%) = 350 \text{ V}$
 $I_C (100\%) = 28 \text{ A}$
 $Q_g = 277 \text{ nC}$

Figure 8 Buck FWD

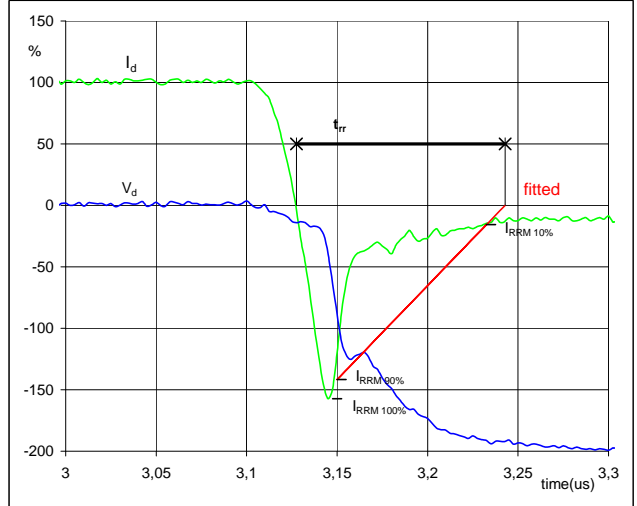
Turn-off Switching Waveforms & definition of t_{rr}

$V_d (100\%) = 350 \text{ V}$
 $I_d (100\%) = 28 \text{ A}$
 $I_{RRM} (100\%) = -44 \text{ A}$
 $t_{rr} = 0,11 \text{ }\mu\text{s}$

Switching Definitions Neutral Point

Figure 9 Boost IGBT

Turn-on Switching Waveforms & definition of t_{Qrr}
 (t_{Qrr} = integrating time for Q_{rr})

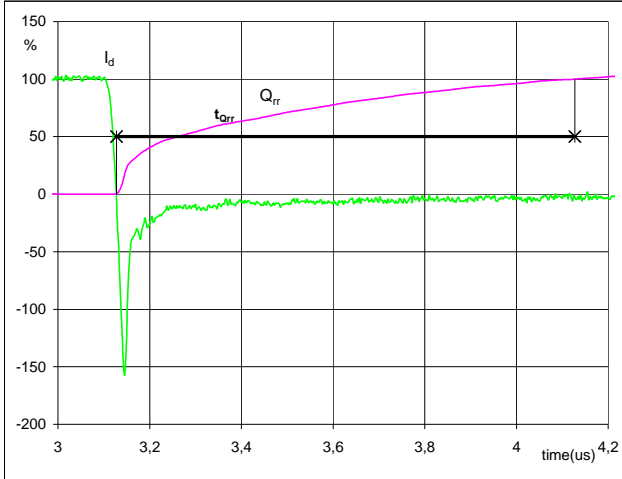

I_d (100%) = 28 A
 Q_{rr} (100%) = 2,73 μ C
 t_{Qrr} = 1,00 μ s

Figure 10 Buck FWD

Turn-on Switching Waveforms & definition of t_{Erec}
 (t_{Erec} = integrating time for E_{rec})

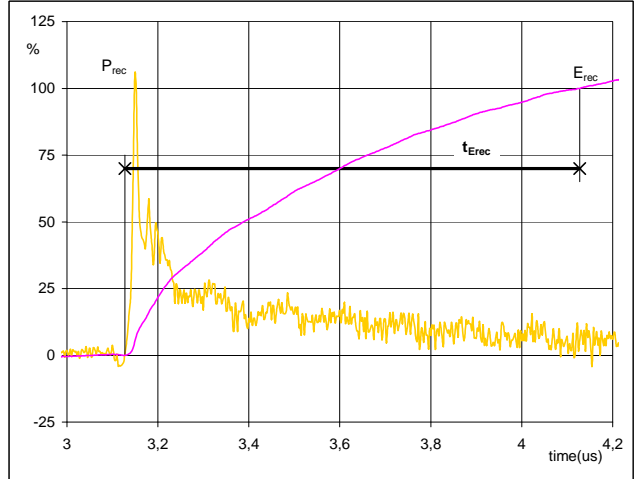

P_{rec} (100%) = 9,70 kW
 E_{rec} (100%) = 0,71 mJ
 t_{Erec} = 1,00 μ s

Measurement circuits

Figure 11

Neutral Point stage switching measurement circuit

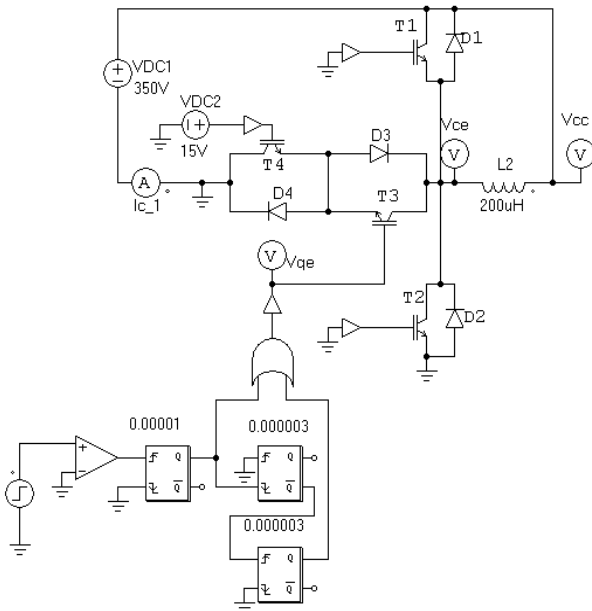

Switching Definitions Half Bridge

General conditions

T_j	=	125 °C
R_{gon}	=	8 Ω
R_{goff}	=	8 Ω

Figure 1 Buck IGBT

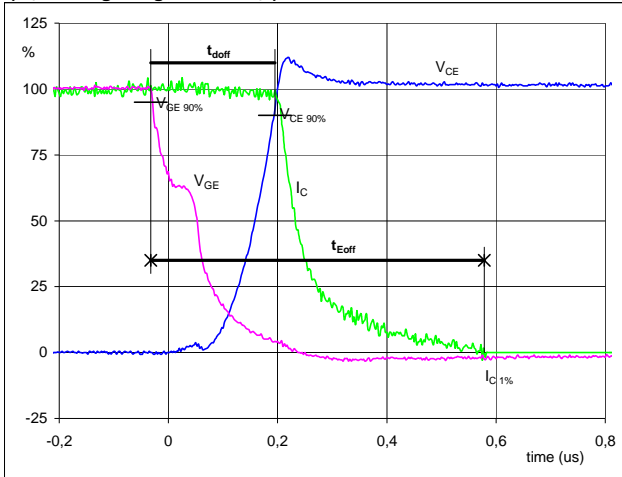
Turn-off Switching Waveforms & definition of t_{doff} , t_{Eoff}
(t_{Eoff} = integrating time for E_{off})

$V_{GE}(0\%) =$	-15	V
$V_{GE}(100\%) =$	15	V
$V_C(100\%) =$	350	V
$I_C(100\%) =$	28	A
$t_{doff} =$	0,22	μs
$t_{Eoff} =$	0,61	μs

Figure 2 Buck IGBT

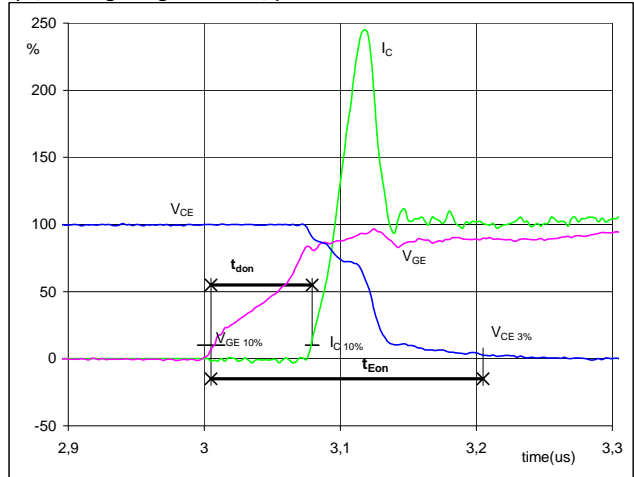
Turn-on Switching Waveforms & definition of t_{don} , t_{Eon}
(t_{Eon} = integrating time for E_{on})

$V_{GE}(0\%) =$	-15	V
$V_{GE}(100\%) =$	15	V
$V_C(100\%) =$	350	V
$I_C(100\%) =$	28	A
$t_{don} =$	0,07	μs
$t_{Eon} =$	0,20	μs

Figure 3 Buck IGBT

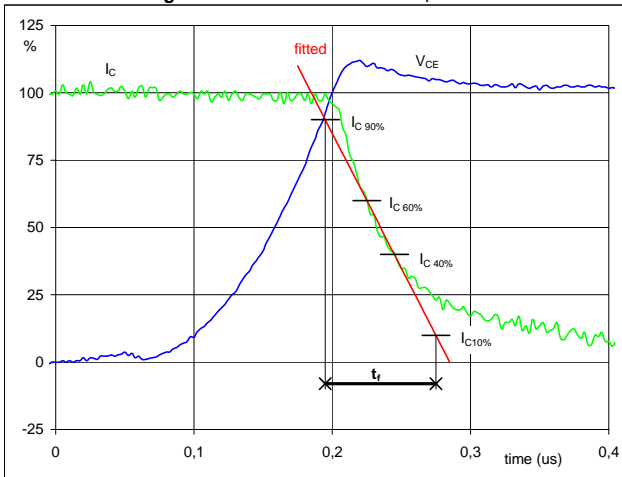
Turn-off Switching Waveforms & definition of t_f

$V_C(100\%) =$	350	V
$I_C(100\%) =$	28	A
$t_f =$	0,08	μs

Figure 4 Buck IGBT

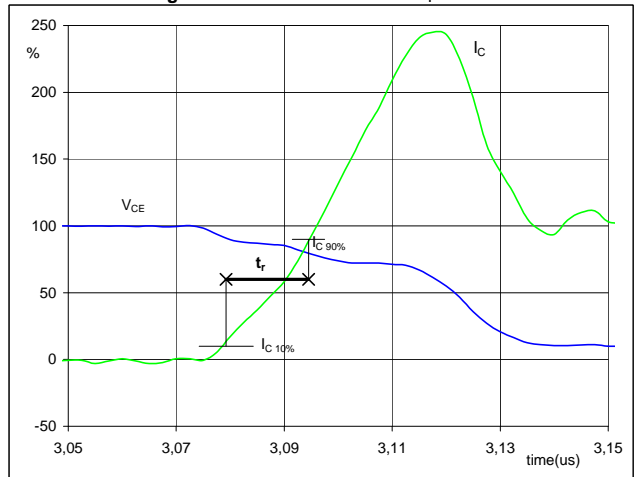
Turn-on Switching Waveforms & definition of t_r

$V_C(100\%) =$	350	V
$I_C(100\%) =$	28	A
$t_r =$	0,02	μs

Switching Definitions Half Bridge

Figure 5 Buck IGBT

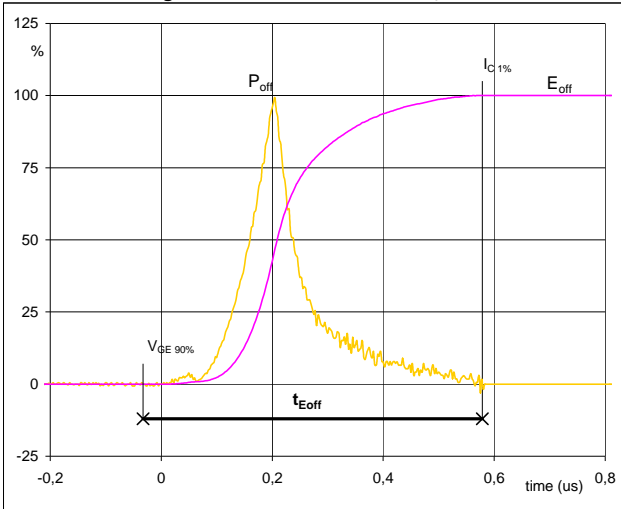
Turn-off Switching Waveforms & definition of t_{Eoff}

$P_{off} (100\%) = 9,75 \text{ kW}$
 $E_{off} (100\%) = 1,16 \text{ mJ}$
 $t_{Eoff} = 0,61 \text{ }\mu\text{s}$

Figure 6 Buck IGBT

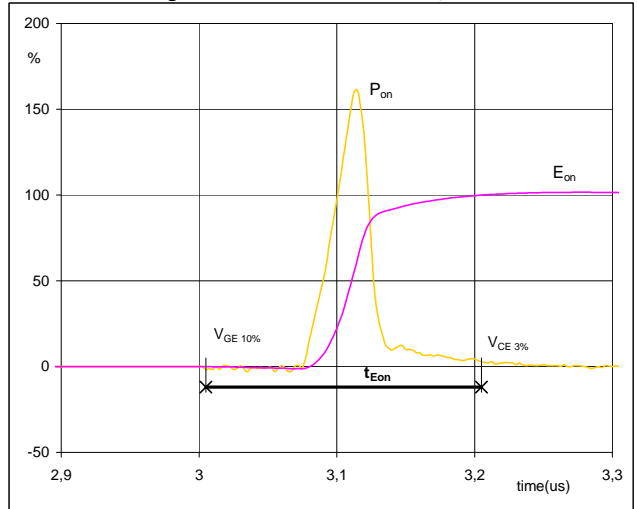
Turn-on Switching Waveforms & definition of t_{Eon}

$P_{on} (100\%) = 9,75 \text{ kW}$
 $E_{on} (100\%) = 0,52 \text{ mJ}$
 $t_{Eon} = 0,20 \text{ }\mu\text{s}$

Figure 7 Buck IGBT

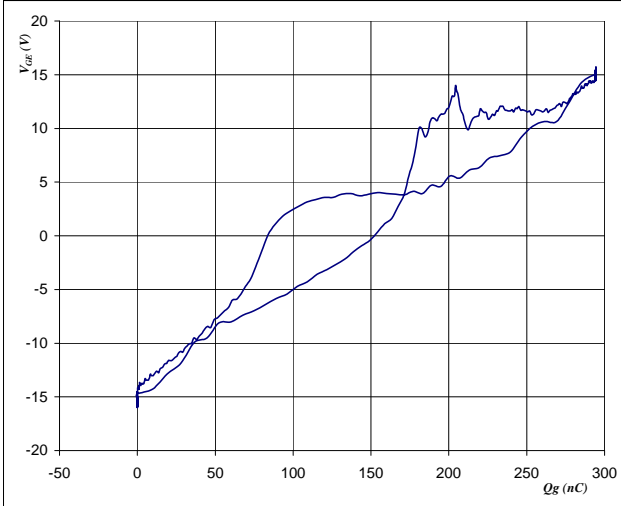
Gate voltage vs Gate charge (measured)

$V_{GEoff} = -15 \text{ V}$
 $V_{GEon} = 15 \text{ V}$
 $V_C (100\%) = 350 \text{ V}$
 $I_C (100\%) = 28 \text{ A}$
 $Q_g = 299,41 \text{ nC}$

Figure 8 Boost FWD

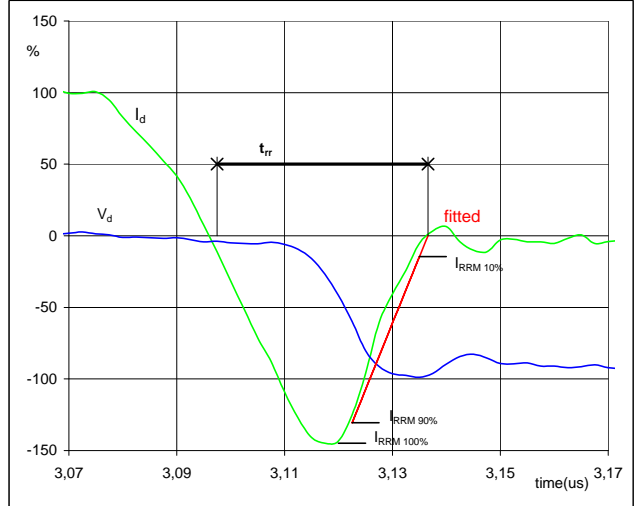
Turn-off Switching Waveforms & definition of t_{rr}

$V_d (100\%) = 350 \text{ V}$
 $I_d (100\%) = 28 \text{ A}$
 $I_{RRM} (100\%) = -41 \text{ A}$
 $t_{rr} = 0,04 \text{ }\mu\text{s}$

Switching Definitions Half Bridge

Figure 9 Buck IGBT

Turn-on Switching Waveforms & definition of t_{Qrr}
 (t_{Qrr} = integrating time for Q_{rr})

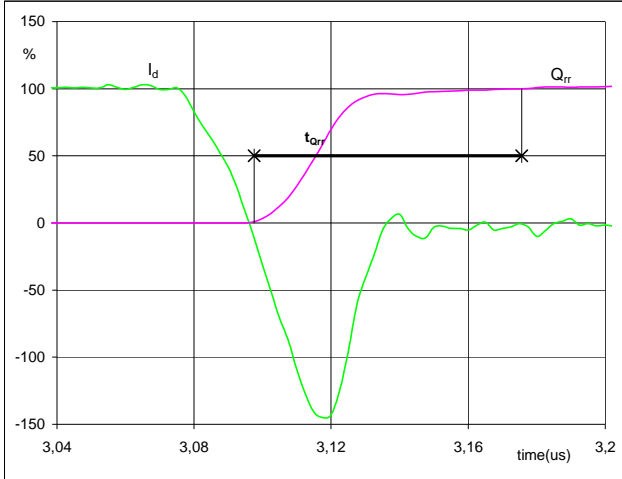

I_d (100%) = 28 A
 Q_{rr} (100%) = 0,92 μ C
 t_{Qrr} = 0,08 μ s

Figure 10 Boost FWD

Turn-on Switching Waveforms & definition of t_{Erec}
 (t_{Erec} = integrating time for E_{rec})

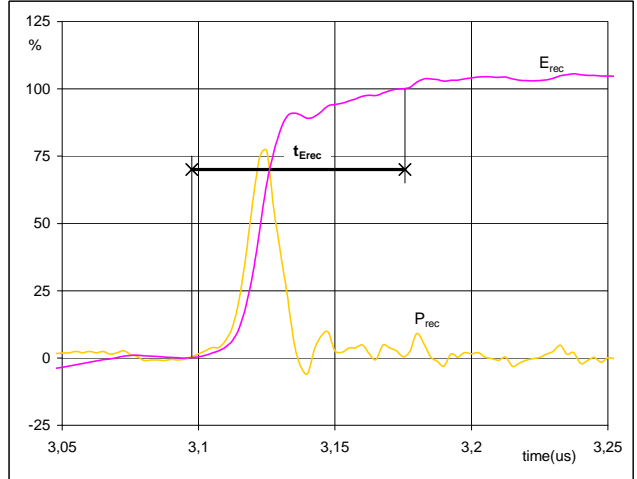

P_{rec} (100%) = 9,75 kW
 E_{rec} (100%) = 0,12 mJ
 t_{Erec} = 0,08 μ s

Measurement circuits

Figure 11

Half Bridge stage switching measurement circuit

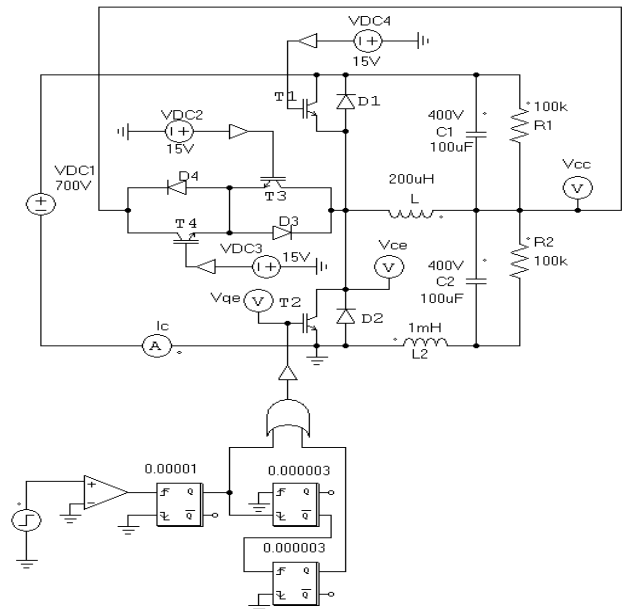

Ordering Code and Marking - Outline - Pinout
Ordering Code & Marking

Version	Ordering Code	in DataMatrix as	in packaging barcode as
without thermal paste 12mm housing	10-FY12M3A040SH-M749F08	M749F08	M749F08
without thermal paste 17mm housing	10-F112M3A040SH-M749F09	M749F09	M749F09

Outline

Pin	X	Y	Pin	X	Y
1	52,2	0	23	21,25	10,7
2	46,2	0	24	21,25	13,7
3	47	3	25	30,4	9,7
4	40,9	0	26	33,4	9,7
5	44	3	27	40,15	11,2
6	34,9	0	28	40,15	8,2
7	34,9	3	29	50,45	10,7
8	28,9	0	30	50,45	13,7
9	25,9	2	31	0	16,35
10	22,9	0	32	0	19,35
11	22,9	3	33	5,45	28,2
12	16,9	0	34	8,25	28,2
13	16,9	3	35	11,25	28,2
14	10,9	0	36	14,25	28,2
15	10,9	3	37	23	28,2
16	6	0	38	26	28,2
17	7,9	3	39	29	28,2
18	0	0	40	31,8	28,2
19	4,75	8,9	41	40,4	28,2
20	1,75	7,9	42	43,2	28,2
21	13,25	13,7	43	46,2	28,2
22	13,25	10,7	44	49,2	28,2

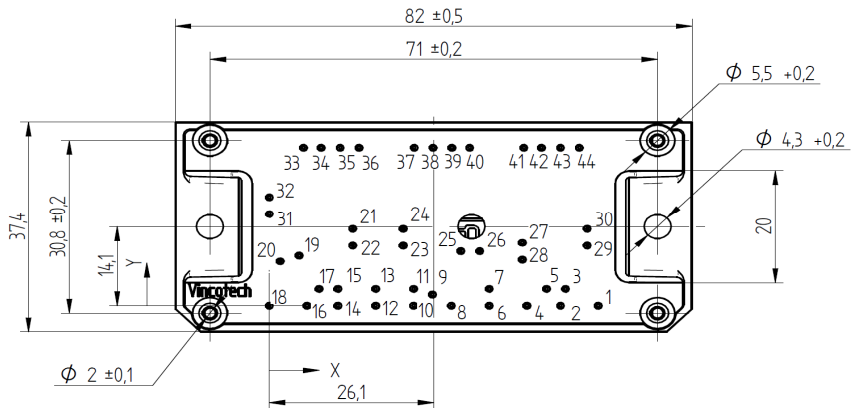
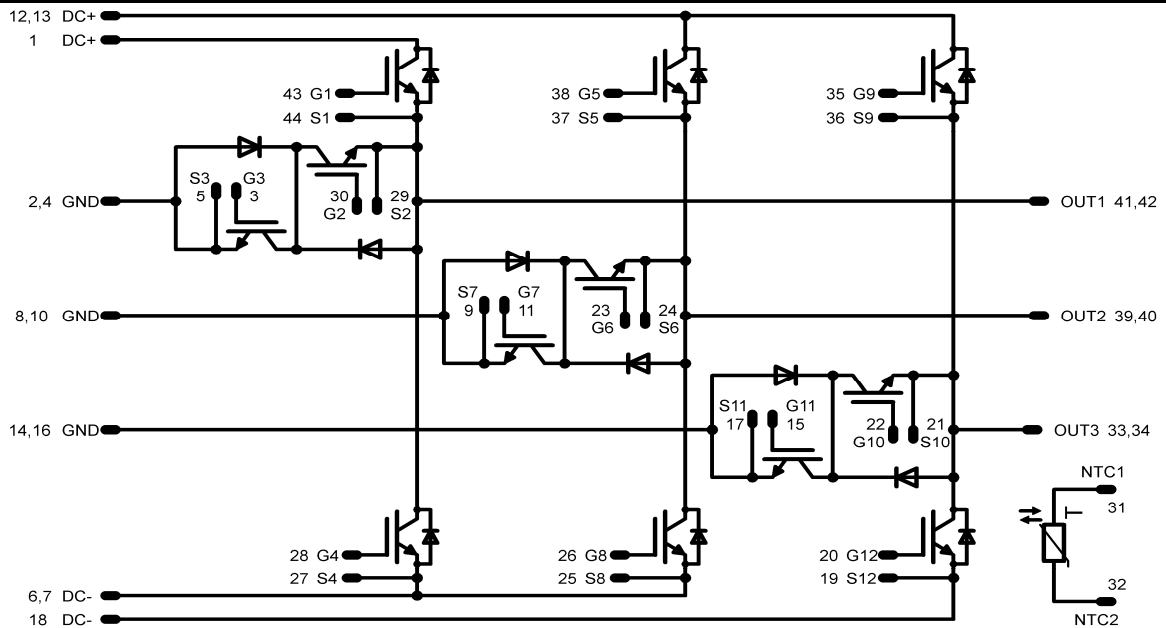
Pinout

DISCLAIMER

The information given in this datasheet describes the type of component and does not represent assured characteristics. For tested values please contact Vincotech. Vincotech reserves the right to make changes without further notice to any products herein to improve reliability, function or design. Vincotech does not assume any liability arising out of the application or use of any product or circuit described herein; neither does it convey any license under its patent rights, nor the rights of others.

LIFE SUPPORT POLICY

Vincotech products are not authorised for use as critical components in life support devices or systems without the express written approval of Vincotech.

As used herein:

1. Life support devices or systems are devices or systems which, (a) are intended for surgical implant into the body, or (b) support or sustain life, or (c) whose failure to perform when properly used in accordance with instructions for use provided in labelling can be reasonably expected to result in significant injury to the user.
2. A critical component is any component of a life support device or system whose failure to perform can be reasonably expected to cause the failure of the life support device or system, or to affect its safety or effectiveness.