

SCIENTIFIC 10-DIGITS LCD CALCULATOR

DESCRIPTION

The SC3442 is the CMOS LSI for a 10-digits display and the complete single chip for scientific calculator with 56 programmed functions.

FEATURES

- * Display
 - 10 display digits plus negative code digits.
 - Scientific and engineering display.
 - 8 mantissa digits plus 2 exponent digits plus 2 negative code digits.

* 14 kinds of special display

M	Memory	GRAD	Gradient
-	Minus	()	Parenthesis
E	Error	BIN	Binary mode
2ndF	2nd Function	OCT	Octal mode
HYP	Hyperbolic	HEX	Hexadecimal mode
DEG	Degree	CMX	Complex number mode
RAD	Radian	STAT	Statistic calculation mode

- * The minus sign of the mantissa is floating minus.
- * The arithmetic key operation has the same sequence as the mathematical equation, 6 pending operations are allowed and () are up to continuous 15 levels.
- * Mutual conversion and calculation in arithmetic among binary, octal, decimal, and hexadecimal numbers.
- * One independent accumulating memory.
- * It is possible to convert and fix the display number system by the F→E key.

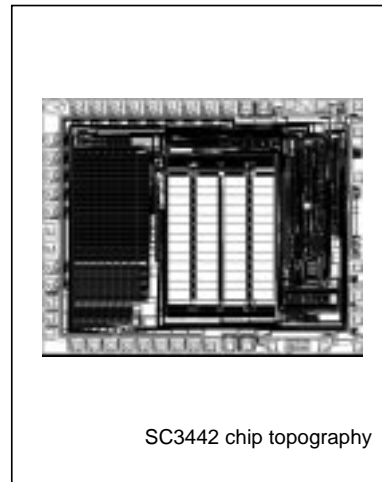

ORDERING INFORMATION

Device	Package	Operating Temperature
SC3442	FL	48 QFP
	RV	
	FW	
SC3442P	Bare Chip	0 ~ +40°C

- * It is possible to specify decimal part digits by the TAB key.
- * Direct drive for LCD (1/3 prebias, 1/4 duty)
- * Automatic power off (about 7.5 minutes)
- * Low power consumption
VDD=3.0V single power supply.
- * 48 QFP and bare chip available

PAD ASSIGNMENT

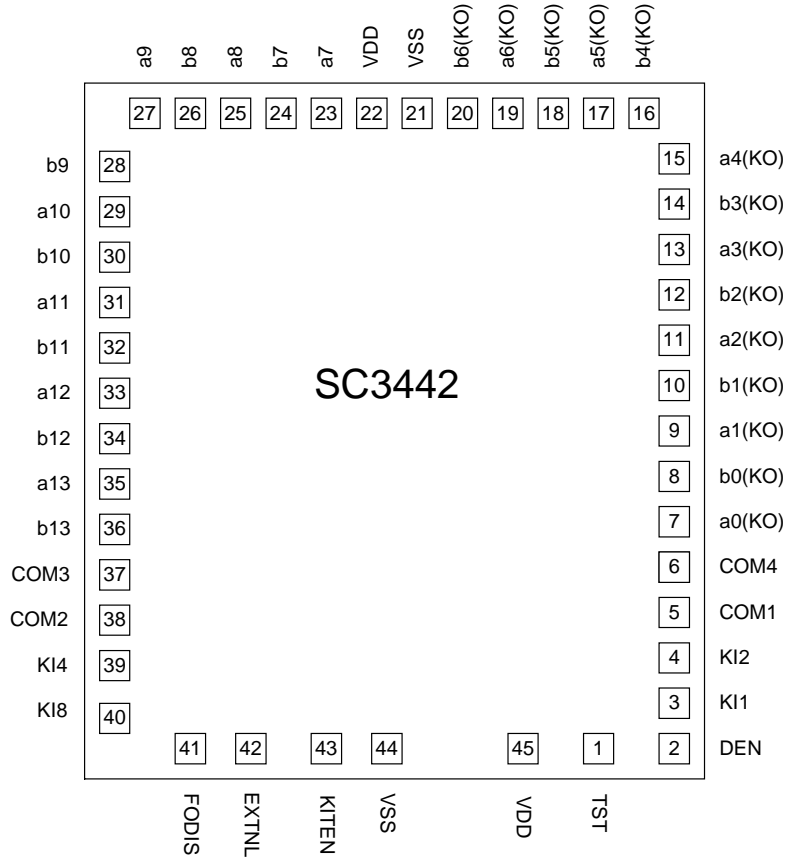

ABSOLUTE MAXIMUM RATINGS

Characteristic	Symbol	Value	Unit
Terminal Voltage	VDD	-0.3 ~ +5.0	V
	VIN	-0.3 ~ VDD+0.3	V
Operating Temperature	Topr	0 ~+40	°C
Storage Temperature	Tstg	-55 ~ +125	°C

ELECTRICAL CHARACTERISTICS (VDD=+3.0V±0.2V, VSS=0V, Tamb=25~70°C)

Parameter	Symbol	Condition	Min	Typ	Max	Unit
Operating Voltage	VDD	--	2.5	3	3.4	V
Supply current	I _{dis}	VDD=3V, Stand by		20	35	μA
	I _{opr}	VDD=3V, Operation		70	120	μA
	I _{off}	VDD=3V, Off		1	3	μA
Osc frequency	F _{dis}	VDD=3V, Stand by	30	45		kHz
	F _{opr}	VDD=3V, Operation		200	280	kHz
Frame frequency	F _f	VDD=3V, Stand by	110	180		Hz
Auto power off	I _{apo}	VDD=3V	300	430	600	Sec
High input voltage (KI8~KI1)	V _{IH}	--	VDD-0.5		VDD	V
Low output voltage (KI8~KI1)	V _{IL}	--	VSS		VSS+0.5	V
High output voltage (KI8, KI4, KI2)	V _{OH}	--	VDD-0.2	VDD	VDD	V
Low output voltage (KI1)	V _{OL}	--	VSS	VSS	VSS+0.2	V
Key pull down resistance (KI1)	F _{pd}	V _{out} =0V	30	50	70	kΩ
Key pull up resistance (KI8, KI4, KI2)	R _{pu}	V _{out} =VDD	30	50	70	kΩ
High output voltage (LCD, COM)	V _{OH}	--	VDD-0.2	VDD	VDD	V
"M" output voltage (LCD, COM)	V _{OM}	--	2/3 VDD -0.2	2/3 VDD	2/3 VDD +0.2	V
"M" output voltage (LCD, COM)	V _{OM}	--	1/3 VDD -0.2	1/3 VDD	1/3 VDD +0.2	V
Low output voltage (LCD, COM)	V _{OL}	--	VSS	VSS	VSS+0.2	V

BASIC SPECIFICATIONS
1. NUMBER OF DISPLAY DIGITS

- 10-digit display and 14 kinds of special displays
- Engineering display
- Max mantissa 8 digits plus exponent 2 digits plus each negative code digit
- Normal display
 - Max. 10 mantissa digits plus 1 negative code 6 digit

2. CLASSIFICATION OF OPERATION MODE

The following 6 types of operation mode are set by the 2ndF key and below keys:

- 2ndF STAT : Statistic calculation mode are set
- 2ndF CPLX : Complex number calculation mode set
- 2ndF - BIN : Binary mode set
- 2ndF - OCT : Octal mode set
- 2ndF - HEX : Hexadecimal mode set
- 2ndF - DEC : Decimal mode set

3. KINDS OF KEYS AND CLASSIFICATION OF THE MULTI-FUNCTIONS FOR ALL 42 TOUCH KEYS

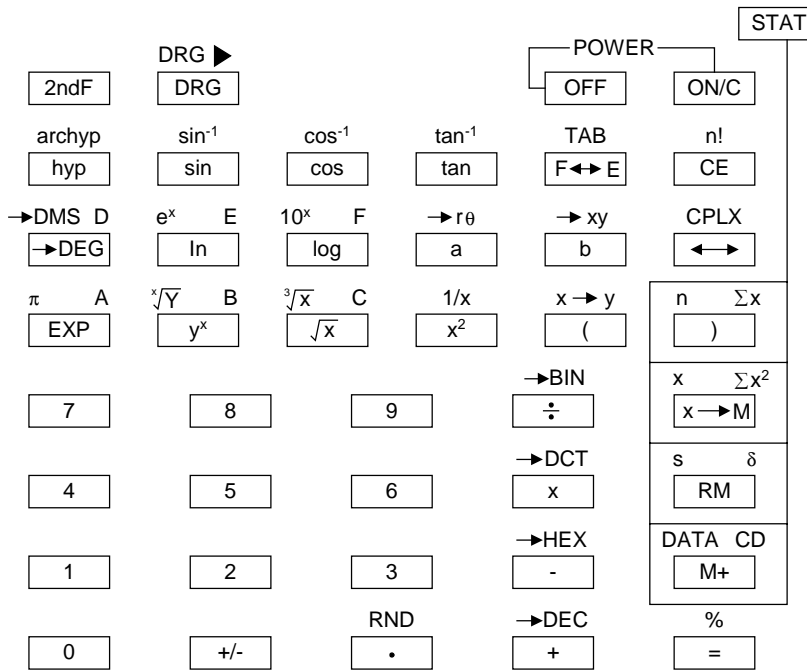

4. THE CONDITION DURING CALCULATION

No key input is allowed and no data is displayed during calculation.

5. DISPLAY METHOD

- a. Set number and result of operation are displayed in the right margin, minus floating.
- b. Display of decimal number operation results.

Display is made according to the display format that has been set by the F↔E key.

• Floating mode

$10^{10} \leq |x| \leq 10^{100}$: Exponent display.

$10^{-99} \leq |x| \leq 10^{-9}$: Exponent display.

0 and $10^{-9} \leq |x| \leq 10^{10}$: Floating display.

• Engineering mode

0 and $10^{-99} \leq |x| \leq 10^{100}$ (all ranges); Exponent display.











The F↔E key also converts the display format of a displayed numerical value simultaneously with the display format setting.

At the same time, the number of digits below the decimal point of the above modes follows the display format assigned by the 2dnF and F↔E keys.

Further, in the same manner as the F↔E key, the conversion is also takes place simultaneously with the display format setting.

When the number of digits is specified, the last digit displayed is a rounded number, and when there is no specification of the number of digits, the last digit displayed is a cut number.

Example:

				0.285714285
	TAB 			0.286
				2.857-01
				2.8571428-01

c. Negative number are not displayed with the minus symbol “-” but are displayed in hexadecimal, octal, and binary two’s complements.

d. Display style and special display

• Display style



• Special display



e. Examples of display

- Floating of -6000 1/x; TAB=7



- Same as above, engineering display



- Error display



6. PROTECTION

a. Memory overflow protection

If the overflow occurs in the memory calculation, the data before the calculation is retained.

b. Statistical overflow protection

If the overflow occurs in the statistical calculation, the data before the calculation is retained.

7. THE NUMBER OF DIGITS OF THE INTERNAL RETAINED DATA.

The number of the digits of the mantissa of the displayed data is a maximum of 10 digits, but the available data for successive calculations is the internally retained data.

The number of digits of the mantissa of internally retained data is as follows:

a. Data input	Maximum	10 digits
b. Arithmetic	Maximum	10 digits
c. Engineering function		
d. Statistical function		
e. Complex number function		
f. Memory calculation		
g. Number of random	Maximum	3 digits

8. AUTO CLEAR

When the power supply is suddenly turned on an auto clear routine is executed to initialize as DEC mode, no TAB, floating, and DEG modes.

9. POWER OFF FUNCTION

a. Auto power off

About 7.5 minutes after operation is ended by pressing the key, the power supply is turned off.

— HANGZHOU SILAN MICROELECTRONICS JOINT-STOCK CO.,LTD —

Rev: 1.0 2000.12.20

b. OFF

Pressing this key will stop the oscillator. (Memory safe guard)

c. ON

Pressing this key will wake the oscillator and initialize.

OPERATION MODE

1. OPERATION MODE

OPERATION		MODE					
		DEC	BIN	OCT	HEX	STAT	CPLX
6 Operation	4 Operation +, -, ×, ÷, =	O	O	O	O	O	O
	Power y^x , $\sqrt[y]{x}$	O	X	X	X	O	X
	Parenthesis ()	O	O	O	O	X	X
	Constant calculation	O	O	O	O	O	X
	Percentage calculation	O	X	X	X	O	X
STAT	Statistical calculation	X	X	X	X	O	X
CPLX	CPLX calculation	X	X	X	X	X	O
	Input a, b	O	X	X	X	X	O
DATA setting	Numeric input 0, 1	O	O	O	O	O	O
	Numeric input (2~7)	O	X	O	O	O	O
	Numeric input 8, 9	O	X	X	O	O	O
	Hex input A~F	X	X	X	O	X	X
	•, Exp	O	X	X	X	O	O
	+/-	O	O	O	O	O	O
	Shit key	O	O	O	O	O	O
CE		O	O	O	O	O	O
Memory	Memory calculation	O	O	O	O	O	O
Display conversion	F←E, TAB	O	X	X	X	X	X
P-R conversion	P→ R→P	O	X	X	X	X	O
Random	RND	O	X	X	X	O	O
Function	1 variable function	O	X	X	X	O	O
Augular conversion	DRG	O	X	X	X	O	O
	DRG▶						

2. The calculation is always shifted to a specified mode by mode keys

A Mode → B Mode

A \ B	DEC	BIN	OCT	HEX	STAT	CPLX
DEC	NOP	DEC Conversion	DEC Conversion	DEC Conversion	DEC Conversion State clear	DEC Conversion State clear
BIN	BIN Conversion	NOP	BIN Conversion	BIN Conversion	BIN Conversion State clear	BIN Conversion State clear
OCT	OCT Conversion	OCT Conversion	NOP	OCT Conversion	OCT Conversion State clear	OCT Conversion State clear
HEX	HEX Conversion	HEX Conversion	HEX Conversion	NOP	HEX Conversion State clear	HEX Conversion State clear
STAT	Display Clear	Display Clear	Display Clear	Display Clear	NOP	Display Clear
CPLX	Display Clear	Display Clear	Display Clear	Display Clear	Display Clear State clear	NOP

NOP: No operation

KEY DEFINITIONS
(1) 2ndF

This is the key for specifying the second function.

When this key is pressed, the special display "2ndF" lights. When this key is pressed twice the second function mode is released.

(2) DRG DRG ►

a. Pressing this key will change the mode of angle sequentially.

► DEG → RAD → GRAD ◻ and display it.

b. Pressing this key will change the mode of the angle and will convert the displayed data.

$$\text{DEG} \rightarrow \text{RAD} \quad : \quad \text{RAD} = \text{DEG} \times \frac{\pi}{180}$$

$$\text{RAD} \rightarrow \text{GRAD} \quad : \quad \text{GRAD} = \text{RAD} \times \frac{200}{\pi}$$

$$\text{GRAD} \rightarrow \text{DEG} \quad : \quad \text{DEG} = \text{GRAD} \times 0.9$$

(3) 0~9

- In setting data in the mantissa section, it is set at the right margin, and the data in more than 11 digits cannot be input.
- At the data input against the exponent, the last two numbers are efficient.

(4) • RND

- The position first pressed has preference, and no input is made to data set in the exponent section.
- When pressed as the first set number, it is regarded as 0 and • keys are pressed.
- Random as a 2ndF
Pressing this key shall display the random numbers.
The range of random numbers is 0.000~0.999.

(5) +/-

- In setting data in the mantissa section, this key reverses the code in the mantissa section.
Similarly, for the exponent section, it reverses the code in the exponent section.
- For the operation result, this key reverse codes in the mantissa section.

(6) + - x ÷ = ()

- When the key operation are performed by these keys according to a numerical expression, a result of the operation is obtained according to mathematical priorities. Priorities discriminated are:
 - 1 Variable function
 - 2 Expression in (); (The most inner expression has priority in case of multiple parentheses)
 - 3) y^x , $\sqrt[x]{y}$
 - 4) x , \div
 - 5) $+$, $-$
- Whenever the key is operated, the calculator discriminates the above priorities and holds the data and operation keys pending as required.
This pending action is possible up to 6 times and 7 or more pending become error.
- (Key is accepted only immediately after CE, +, -, \times , \div , y^{3x} , $\sqrt[x]{y}$, =, (keys and not accepted in all other cases.
When this key is accepted, the displayed data is cleared to 0.
When (key is first accepted, the special display "()" illuminates.
When a parenthesis expression is completed) and = keys or when it is cleared by the ON/C key, etc, or when errors are generated, the special display "()" goes out.
- If it is within the allowable range of pending, (can be input into any place in an expression as many times as desired. However, if the key is pressed continuously 16 times or more, it be comes error.
- From a viewpoint of numerical expression, even when the corresponding C key is not pressed, the operation is not executed if the ")" key is pressed. On the other hand, when the "(" key is pressed and the "=" key is pressed without pressing the corresponding ")" key, the operation is also completed according to the priority.

7. Memory calculation (x→M, RM, M+)

- The memory register "M" used by these keys is a completely independent single memory.
- Display data is added to "M" (memory register) by M+ key.
- Display data is stored in "M" by x→M key.
- Contents of "M" is displayed by MR key.
- When any data except for 0 is stored in "M", the special display "M" illuminates.

8. π

- This key displays a rounded value (3.14592654) of a 12-digit value (3.1459265359) according to the set display format.
- A value that is used in a subsequent operation is the above the 12-digit value.
- The display is cleared by the following 1st numeric key and new data is set.

9. % Calculation

- When any arithmetic functions or constant mod has not been set, the displayed number is converted from a percentage to a decimal.

Example) 61.5%

				Display	
6	1	.	5	%	0.615

- When = key is pressed after % with any arithmetic function

• Add-on

$$a+b \quad \% \quad = \quad \rightarrow a + \frac{axb}{100}$$

• Discount

$$a-b \quad \% \quad = \quad \rightarrow a - \frac{axb}{100}$$

• Percentage

$$axb \quad \% \quad = \quad \rightarrow \frac{axb}{100}$$

$$a \div b \quad \% \quad = \quad \rightarrow \frac{a}{b} \times 100$$

• y^x , $\sqrt[x]{y}$

$$a \ y^x \ b \ \% \ = \ \rightarrow a^t \ (t = \frac{b}{100})$$

$$a \ \sqrt[x]{y} \ b \ \% \ = \ \rightarrow \sqrt[t]{a} \ (t = \frac{b}{100})$$

10. Trigonometric and arctrigonometric functions (1 Variable)

(sin cos tan sin⁻¹ cos⁻¹ tan⁻¹)

These functions are calculated according to respective defined areas and accuracy show in (6), and displayed result of operation can become operators.

11. Hyperbolic and archyperbolic function

(hyp→sin cos tan, archyp→sin cos tan)

Same as trigonometric function.

12. Exponential and logarithmic functions
 $(e^x \ 10^x \ \ln \ \log)$

Same as trigonometric functions

13. Reciprocal, square, square root and cube root.
 $(1/x \ x^2 \ \sqrt{\quad} \ , \ \sqrt[3]{\quad})$

Same as trigonometric function

14. Factorial function (n!)
 $n! = n \times (n-1) \times (n-2) \times \dots \times 2 \times 1$

Same as trigonometric

15. → DEG → DMS

- These keys convert degrees, minutes and seconds into decimal degrees and decimal degrees into degree minutes and seconds.
- On the DMS format, the integer part of display data is regarded as degrees, 2 digits below the decimal point as minutes and the 3rd digit and below as seconds.

	1	59	5999
1.999999999	-DMS	degree	minute second

16. Coordinate conversion (a b → r θ → xy)

- These keys convert the rectangular coordinates into the polar coordinates into the rectangular coordinates. The angle units that have been set by the DRG key follows.
- Respective defined areas and accuracy are as shown in (6), however, the range of θ obtained by R→P in degree is as follows:

1st	Quadrant	0° ≤ θ ≤	90°
2nd	Quadrant	90° ≤ θ ≤	180°
3rd	Quadrant	180° ≤ θ ≤	-90°
4th	Quadrant	-90° ≤ θ ≤	0°

- Input of 2 variables is performed by setting.
x or r by pressing a key and
y or θ by pressing b key.
- The operation result of x or R is obtained in the display register of by pressing a key and y or θ by pressing b key.

	Input Data		Result	
	a	b	a	b
R→P (Rectangular→Polar)	x	y	r	θ
P→R (Polar→Rectangular)	r	θ	x	y

$$(\rightarrow r, \theta) r = \sqrt{x^2 + y^2}, \theta = \tan^{-1} y/x$$

$$(\rightarrow x, y) x = r \cos \theta, y = r \sin \theta$$

e. (R→P Conversion) $([x, y] \rightarrow [r, \theta])$ f. (P→R Conversion) $([r, \theta] \rightarrow [x, y])$

Key operation	Display	Key operation	Display
x	x	θ	θ
a	x	b	θ
y	y	r	r
b	y	a	r
$\rightarrow r\theta$	r	$\rightarrow xy$	x
b	θ	b	y

17. Binary mode (2ndF, →BIN, 0, 1)

- Data input and output are both binary integers in a maximum of 10 digits.
- A negative number is expressed in binary number of two's complement.
- The range of internal operation is as shown below and if the result of the operation exceed the range, it becomes an error (overflow)

	Binary Number	Decimal Number
Outside the operation range	—	$512 \leq \text{DATA}$
Binary Positive Integer	1 1 1 1 1 1 1 1 1 1	511
	1 1 1 1 1 1 1 1 1 0	510
	1 1 1 1 1 1 1 1 0 1	509
	:	:
	:	:
	10	2
	1	1
0	0	
Binary Positive Integer (Complement)	1 1 1 1 1 1 1 1 1 1	-1
	1 1 1 1 1 1 1 1 1 0	-2
	1 1 1 1 1 1 1 1 0 1	-3
	:	:
	:	:
	1 0 0 0 0 0 0 0 0 1	-511
1 0 0 0 0 0 0 0 0 0	-512	
Outside the operation range		$-512 \leq \text{DATA}$

18. Octal mode (2ndF, →OCT, 0~7)

- Data input and output are both octal integers with a maximum of 10 digits.
- A negative number is expressed in the octal number display of two's complement.

c. The range of internal operation is as shown below and if the result of the operation exceeds the rang, it becomes an error (overflow)

	Octal Number	Decimal Number
Outside the operation range	—	5 3 6 8 7 0 9 1 $2 \leq \text{DATA}$
Binary Positive Integer	3 7 7 7 7 7 7 7 7	5 3 6 8 7 0 9 1 1
	3 7 7 7 7 7 7 7 6	5 3 6 8 7 0 9 1 0
	:	:
	:	:
	1 0	1 0
Octal Positive Integer (Complement)	7 7 7 7 7 7 7 7 7	-1
	7 7 7 7 7 7 7 7 6	-2
	1 1 1 1 1 1 1 0 1	:
	:	:
	:	:
	4 0 0 0 0 0 0 0 0 1 4 0 0 0 0 0 0 0 0 0	-5 3 6 8 7 0 9 1 1 -5 3 6 8 7 0 9 1 2
Outside the operation range		-5 3 6 8 7 0 9 1 $3 \leq \text{DATA}$

19. Hexadecimal Mode (2ndF, →HEX, 0~9, A~F)

- Data input and output are both hexadecimal integers with a maximum of 10 digits.
- A negative number is expressed in a hexadecimal number of two's complement.
- The range of internal operation is as shown below and if the result of operation exceeds the range, it becomes an error (overflow)

	Hexadecimal Number	Decimal Number
Outside the operation range	—	$1 \times 10^{10} \leq \text{DATA}$
Hexadecimal Positive Integer	2 5 4 0 B E 3 F F	9 9 9 9 9 9 9 9 9 9
	2 5 4 0 B E 3 F E	9 9 9 9 9 9 9 9 9 8
	:	:
	:	:
	1 0	1 0
Hexadecimal Positive Integer (Complement)	F F F F F F F F F F	-1
	F F F F F F F F F E	-2
	1 1 1 1 1 1 1 0 1	:
	:	:
	:	:
	F D A B F 4 1 C 0 2 F D A B F 4 1 C 0 1	- 9 9 9 9 9 9 9 9 9 8 - 9 9 9 9 9 9 9 9 9 9
Outside the operation range		$-1 \times 10^{10} \geq \text{DATA}$

20. Complex number mode (2ndF, CPLX)

- Pressing these keys shall set the complex number mode.
- Input of 2 parts is performed by setting the real part (X; pressing a key) and the imaginary part (Y; pressing b key)
- The operation result of the real part is obtained by pressing = or a key and the imaginary part by pressing b key.

Item	Input Data 1		Function	Input Data 2		Result	
	Real	Imaginary		Real	Imaginary	Real	Imaginary
	a	b		a	b	a	b
Addition	X1	Y1	+	X2	Y2	X1+X2	Y1+Y2
Subtraction	X1	Y1	-	X2	Y2	X1-X2	Y1-Y2
Multiplication	X1	Y1	X	X2	Y2	X1X2-Y1Y2	Y1X2+X1Y2
Division	X1	Y1	÷	X2	Y2	$\frac{X1X2 + Y1Y2}{X2^2 + Y2^2}$	$\frac{Y1X2 - X1Y2}{X2^2 + Y2^2}$

21. Static calculation mode (2ndF, STAT)

- Pressing these keys shall set the static calculation mode.
- The available number of data is a positive integer, such as $0 \leq n \leq 9999999999$, and when the number of data exceeds this integer, it becomes an error.
- The input range of the data is as follows: $0 \leq |data| \leq 1 \times 10^{50}$
This data exceeds the ranges, it becomes an error.
- $n \sum x \quad \sum x^2$

These keys display the number of data (sample), each sum total of x and sum total of x^2

• Average; $x = \frac{\sum_{i=1}^n x_i}{n} = \frac{\sum x}{n}$

- The standard deviation of the sample

$$s = \sqrt{\frac{\sum_{i=1}^n (x_i - \bar{x})^2}{n-1}} = \sqrt{\frac{\sum x^2 - (\sum x)^2/n}{n-1}}$$

- The standard deviation of the population

$$\delta = \sqrt{\frac{\sum_{i=1}^n (x_i - \bar{x})^2}{n}} = \sqrt{\frac{\sum x^2 - (\sum x)^2/n}{n}}$$

ERROR CONDITIONS

- (1) The result of operation in exponent parts exceed+99
- (2) Entering more than the calculation range (6) of each function.
- (3) Dividing by zero.
- (4) In statistical calculation
 - a. x , s , σ when $n=0$
 - b. s when $n=1$
- (5) The number of pending operations exceeds 3
- (6) The number of the parenthesis in the one level exceeds 15.

OPERATION RANGE AND ACCURACY

Function	Angle Unit	Operation Range	Under Flow Area	Normal Accuracy
sin x	DEG	$0 \leq x \leq 4.499999999 \times 10^{10}$	$0 \leq x \leq 5.729577951 \times 10^{-98}$	10 digits ± 1
	RAD	$0 \leq x \leq 7853981633$	--	
	GARD	$0 \leq x \leq 4.999999999 \times 10^{10}$	$0 \leq x \leq 6.366197723 \times 10^{-98}$	
cos x	DEG	$0 \leq x \leq 4.500000008 \times 10^{10}$	--	
	RAD	$0 \leq x \leq 7853981649$	--	
	GARD	$0 \leq x \leq 5.000000009 \times 10^{10}$	--	
tan x	DEG	Same as sin x	Same as sin x	
	RAD	Same as sin x	Same as sin x	
	GARD	Same as sin x	Same as sin x	
$\sin^{-1} x$	DEG	$0 \leq x \leq 1$	$0 \leq x \leq 1.570796326 \times 10^{-99}$	
	RAD	$0 \leq x \leq 1$	--	
	GARD	$0 \leq x \leq 1$	$0 \leq x \leq 1.570796326 \times 10^{-99}$	
$\cos^{-1} x$	DEG	Same as $\sin^{-1} x$	--	
	RAD	Same as $\sin^{-1} x$	--	
	GARD	Same as $\sin^{-1} x$	--	
$\tan^{-1} x$	DEG	$0 \leq x \leq 9.999999999 \times 10^{99}$	Same as $\sin^{-1} x$	
	RAD	$0 \leq x \leq 9.999999999 \times 10^{99}$	--	
	GARD	$0 \leq x \leq 9.999999999 \times 10^{99}$	Same as $\sin^{-1} x$	
In x		$0 \leq x$	--	
log x		$0 \leq x$	--	

(to be continued)

(continued)

Function	Operation Range	Under Flow Area	Normal Accuracy
e^x	$-9.999999999 \times 10^{99} \leq x \leq 230.2585092$	$-9.999999999 \times 10^{99} \leq x \leq -227.9559243$	10 digits ± 1
10^x	$-9.999999999 \times 10^{99} \leq x \leq 99.99999999$	$-9.999999999 \times 10^{99} \leq x \leq -99.00000001$	
$X!$	$0 \leq x \leq 69$ (integer)	--	
$1/x$	$1 \times 10^{-99} \leq x \leq 9.999999999 \times 10^{99}$	$1.000000001 \times 10^{99} \leq x \leq 9.999999999 \times 10^{99}$	
X^2	$0 \leq x \leq 9.999999999 \times 10^{49}$	$0 \leq x \leq 3.162277660 \times 10^{-50}$	
\sqrt{x}	$0 \leq x \leq 9.999999999 \times 10^{99}$	--	
$\sqrt[3]{x}$	$0 \leq x \leq 9.999999999 \times 10^{99}$	--	
DMS→DEG	$0 \leq x \leq 9.999999999 \times 10^9$	--	
DEG→DMS	$0 \leq x \leq 9.999999999 \times 10^9$	$0 \leq x \leq 2.777777777 \times 10^{99}$	
$\sinh x$	$0 \leq x \leq 230.2585092$	--	
$\cosh x$	$0 \leq x \leq 230.2585092$	--	
$\tanh x$	$0 \leq x \leq 9.999999999 \times 10^{99}$	--	
$\sinh^{-1} x$	$0 \leq x \leq 4.999999999 \times 10^{99}$	--	
$\cosh^{-1} x$	$1 \leq x \leq 4.999999999 \times 10^{99}$	--	
$\tanh^{-1} x$	$0 \leq x \leq 9.999999999 \times 10^{-1}$	--	
R→P(x, y)(r, θ)	$ x , y \leq 9.999999999 \times 10^{49}$ $(x^2 + y^2) \leq 9.999999999 \times 10^{99}$	correspond to the under flow area of tanx	
P→R(r, θ) (x, y)	$0 \leq r \leq 9.999999999 \times 10^{99}$ θ correspond to the operation range of sinx, cosx	θ correspond to the under flow area of sinx, cosx	
DEG→RAD	$0 \leq x \leq 9.999999999 \times 10^{99}$	$0 \leq x \leq 5.729577951 \times 10^{98}$	
RAD→GARD	$0 \leq x \leq 1.570796326 \times 10^{98}$	--	
GARD→DEG	$0 \leq x \leq 9.999999999 \times 10^{99}$	$0 \leq x \leq 1.111111111 \times 10^{99}$	
y^x	$-9.999999999 \times 10^{99} \leq x. \ln y \leq 230.2585092$	$-9.999999999 \times 10^{99} \leq x. \ln y \leq -227.9559243$	
	i) $y > 0$; The above — mentioned operation range ii) $y < 0$; x (integer) or $1/x$ ($x = \text{odd}, x \neq 0$) The above — mentioned operation range iii) $y = 0$; $x > 0$		

(to be continued)

(continued)

Function	Operation Range	Under Flow Area	Normal Accuracy
$\sqrt[y]{x}$	$-9.999999999 \times 10 \leq 1/x$. In $ y \leq 230.2585092$	$-9.999999999 \times 10 \leq 1/x$. In $ y \leq -227.9559243$	10 digits ± 1
	i) $y > 0$; The above — mentioned operation range ii) $y < 0$; x (odd) or $1/x$ (integer, $x \neq 0$) The above — mentioned operation range iii) $y = 0$; $x > 0$		
→DEC	The following operation range after the conversion. $0 \leq x \leq 9999999999$		--
→BIN	The following operation range after the conversion. $1000000000 \leq x \leq 1111111111$, $0 \leq x \leq 1111111111$		--
→OCT	The following operation range after the conversion. $4000000000 \leq x \leq 777777777$, $0 \leq x \leq 377777777$		--
→HEX	The following operation range after the conversion. $FDABF41C01 \leq x \leq FFFFFFFF$, $0 \leq x \leq 2540BE3FF$		--
Complex number calculation	$(X1+Y1i) +, -, \times, \div (X2+Y2i)$ i) Addition and subtraction $ X1+X2 \leq 9.999999999 \times 10^{99}$ $ Y1+Y2 \leq 9.999999999 \times 10^{99}$ ii) Multiplication $ X1X2-Y1Y2 \leq 9.999999999 \times 10^{99}$ $ Y1X2-X1Y2 \leq 9.999999999 \times 10^{99}$ $ X1X2 , Y1Y2 , Y1X2 , X1Y2 \leq 9.999999999 \times 10^{99}$ iii) Division $\left \frac{X1X2 + Y1Y2}{X2^2 + Y2^2} \right , \left \frac{Y1X2 - X1Y2}{X2^2 + Y2^2} \right \leq 9.999999999 \times 10^{99}$ $ X2+Y2 , X2 , Y2 , X1X2+Y1Y2 , Y1X2-X1Y2 , X1X2 , Y1Y2 , Y1X2 , X1Y2 \leq 9.999999999 \times 10^{99}$		10 digits ± 1
Statistical calculation	i) Data; $ x \leq 9.999999999 \times 10$ ii) $ \sum x \leq 9.999999999 \times 10$ iii) $ \sum x^2 \leq 9.999999999 \times 10$ vi) $x; n=0$ v) $s; n=1$ $n=0$ $0 \leq \frac{\sum x^2 - (\sum x)^2 / n}{n^{-1}} \leq 9.999999999 \times 10$ vi) $\sigma; n=0$ $0 \leq \frac{\sum x^2 - (\sum x)^2 / n}{n} \leq 9.999999999 \times 10$		10 digits ± 1

LCD CONNECTION

a. Segment

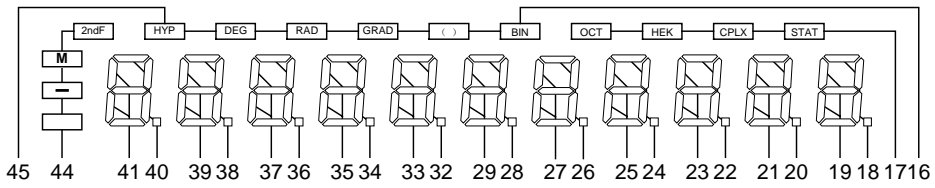

b. Common

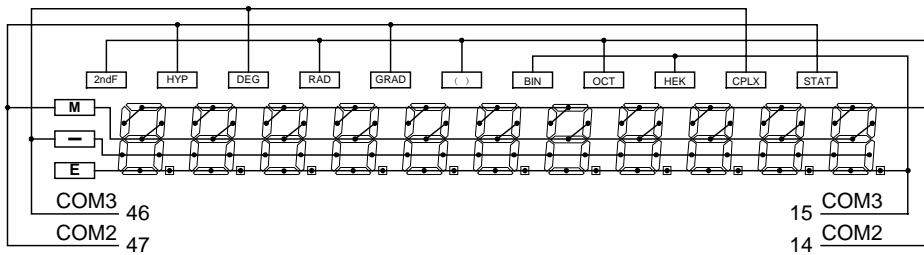

WAVEFORM OF COM

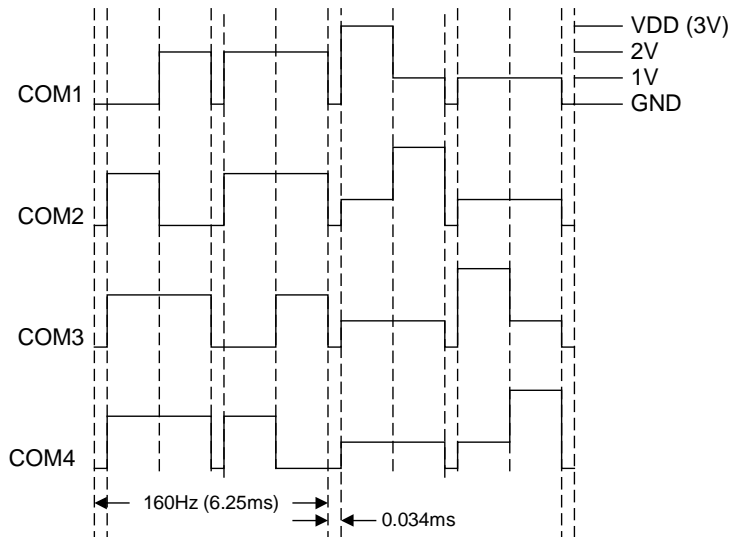

PIN DESCRIPTION

Pin No.	Signal	I/O	Description	Pad No.	Pin No.	Signal	I/O	Description	Pad No.
1	K18	I	Key input 8	40	25	b4(KO)	O	LCD (Key Output)	16
2	FODIS	I	FOSC disable	41	26	a5(KO)	O	LCD (Key Output)	17
3	EXTNL	I	External clock	42	27	b5(KO)	O	LCD (Key Output)	18
4	KITEN	I	Key in test enable	43	28	a6(KO)	O	LCD (Key Output)	19
5	NC				29	b6(KO)	O	LCD (Key Output)	20
6	VSS		VSS Power (GND)	44	30	VSS		VSS Power(GND)	21
7	NC				31	VDD		VDD Power(+3V)	22
8	VDD		VDD Power (+3V)	45	32	a7	O	LCD	23
9	NC				33	b7	O	LCD	24
10	TST	I/O	Test	1	34	a8	O	LCD	25
11	DEN	I	Dump Enable	2	35	b8	O	LCD	26
12	KI1	I	Key Input 1	3	36	a9	O	LCD	27
13	KI2	I	Key Input 2	4	37	b9	O	LCD	28
14	COM1	O	Common Signal 1	5	38	a10	O	LCD	29
15	COM4	O	Common Signal 4	6	39	b10	O	LCD	30
16	a0(KO)	O	LCD (Key Output)	7	40	a11	O	LCD	31
17	b0(KO)	O	LCD (Key Output)	8	41	b11	O	LCD	32
18	a1(KO)	O	LCD (Key Output)	9	42	a12	O	No Connection	33
19	b1(KO)	O	LCD (Key Output)	10	43	b12	O	No Connection	34
20	a2(KO)	O	LCD (Key Output)	11	44	a13	O	LCD	35
21	b2(KO)	O	LCD (Key Output)	12	45	b13	O	LCD	36
22	a3(KO)	O	LCD (Key Output)	13	46	COM3	O	Common Signal 3	37
23	b3(KO)	O	LCD (Key Output)	14	47	COM2	O	Common Signal 2	38
24	a4(KO)	O	LCD (Key Output)	15	48	K14	I	Key Input 4	39

KEY CONNECTIONS

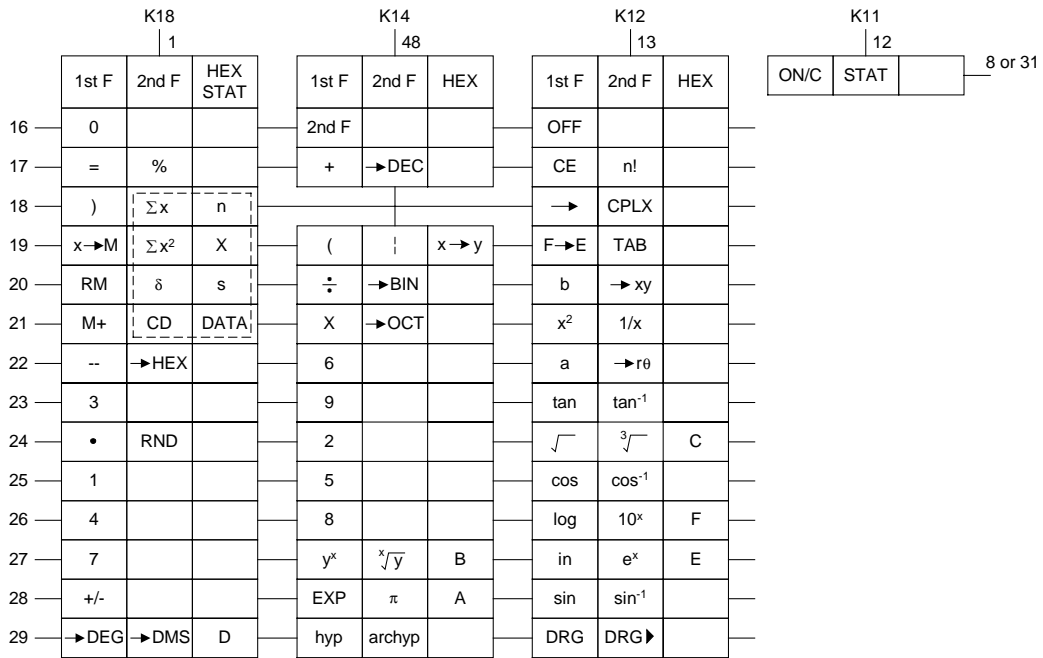

NOTE: =STATISTIC MODE KEYS

APPLICATION CIRCUIT

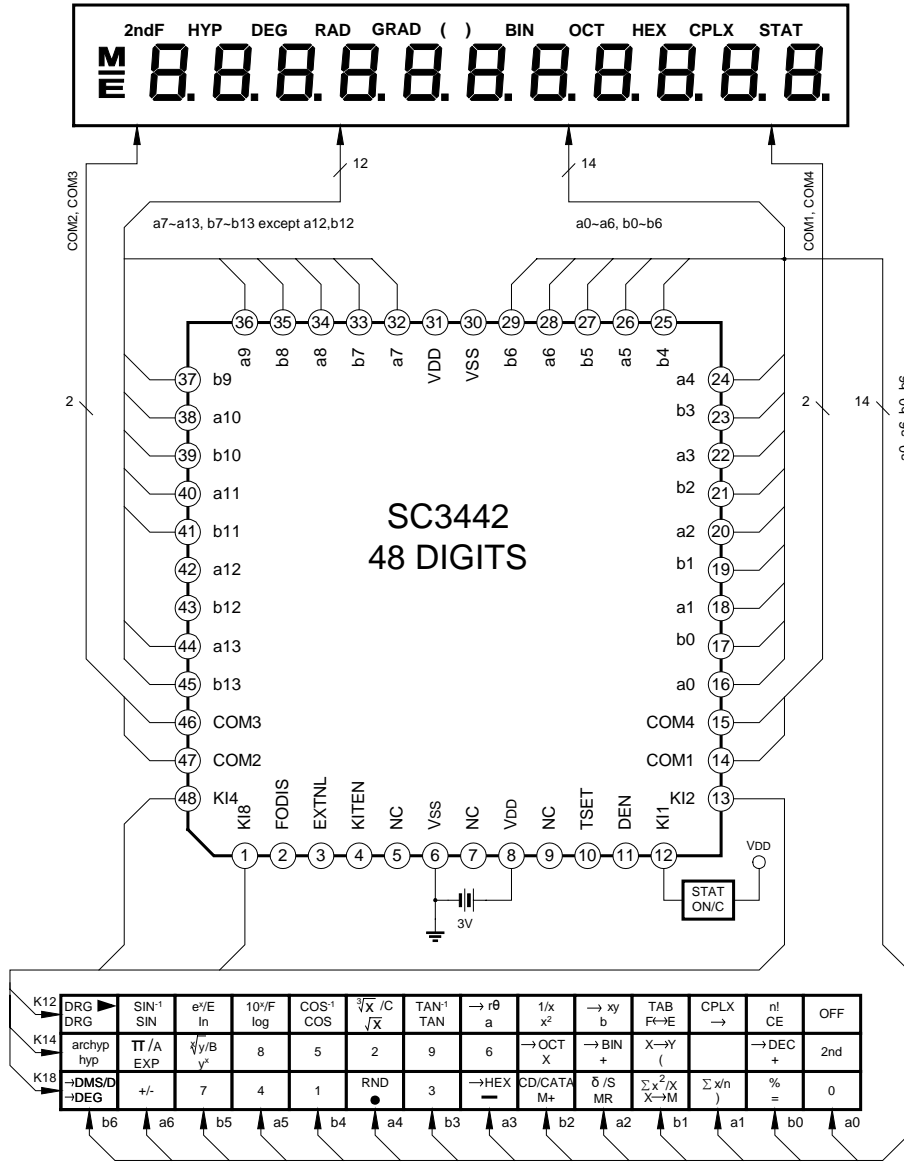

* NOTE

2nd F	2nd F	HEX
1st F	1st F	

* SC3442's substrate (the back side of SC3442's chip) should be connected to the VSS (GND) level.

— HANGZHOU SILAN MICROELECTRONICS JOINT-STOCK CO.,LTD —

Rev: 1.0 2000.12.20

PAD DIAGRAM

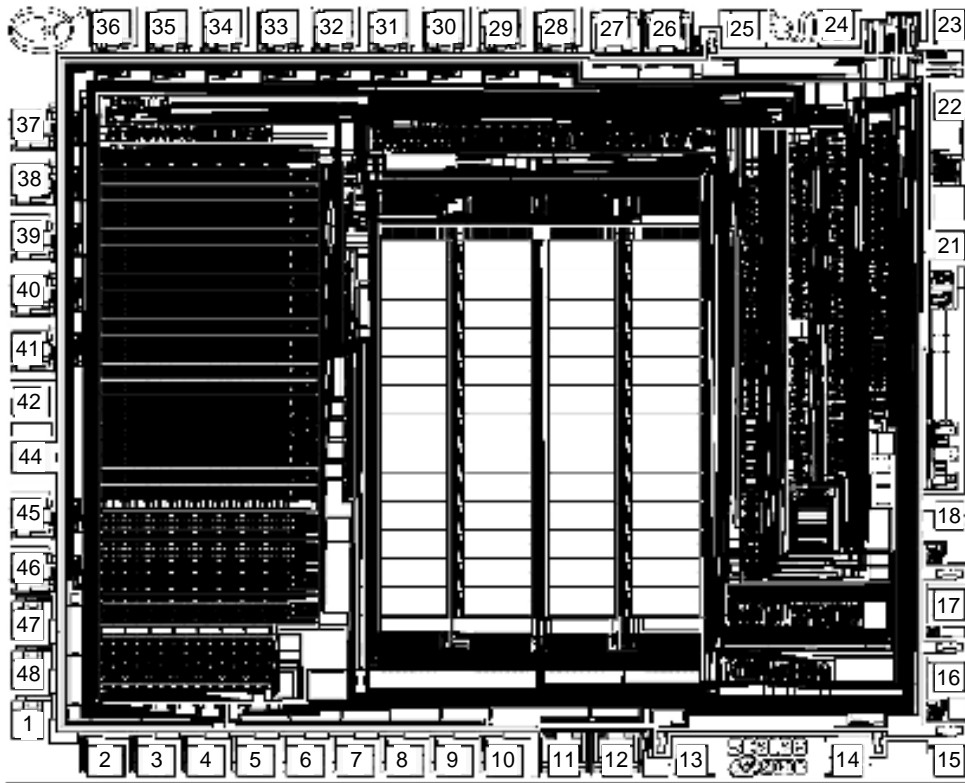

Chip size: 3.50X2.83mm²

PAD COORDINATES

Pad No.	Symbol	X	Y	Pad No.	Symbol	X	Y
1	TST	1266.4	1035.6	25	a8	-1664.0	-834.2
2	DEN	1664.0	1328.8	26	b8	-1644.0	-1014.2
3	KI1	1664.0	1328.8	27	a9	-1664.0	-1194.2
4	KI2	922.0	1328.8	28	b9	-1367.2	-1329.2
5	COM1	646.6	1328.8	29	a10	-1187.2	-1329.2
6	COM4	456.8	1328.8	30	b10	-1007.2	-1329.2
7	a0(KO)	256.8	1328.8	31	a11	-827.2	-1329.2
8	b0(KO)	56.6	1328.8	32	b11	-647.2	-1329.2
9	a1(KO)	-143.4	1328.8	33	a12	-467.2	-1329.2
10	b1(KO)	-343.2	1328.8	34	b12	-287.2	-1329.2
11	a2(KO)	-543.4	1328.8	35	a13	-107.2	-1329.2
12	b2(KO)	-743.8	1328.8	36	b13	72.8	-1329.2
13	a3(KO)	-943.4	1328.8	37	COM3	272.8	-1329.2
14	b3(KO)	-1143.2	1328.8	38	COM2	462.8	-1329.2
15	a4(KO)	-1343.4	1328.8	39	K14	734.4	-1329.2
16	b4(KO)	-1664.0	965.8	40	K18	1294.2	-1329.2
17	a5(KO)	-1664.0	765.8	41	FODIS	1664.0	-1329.2
18	b5(KO)	-1664.0	565.8	42	EXTNL	1664.0	-1028
19	a6(KO)	-1664.0	365.8	43	KITEN	1664.0	-764.2
20	b6(KO)	-1664.0	165.8	44	VSS	1664.0	-445.2
21	VSS	1664.0	-34.2	45	VDD	1664.0	533.2
22	VDD	-1664.0	-234.2				
23	a7	-1664.0	-434.2				
24	b7	-1664.0	-634.2				

Note: The original point of the coordinate is the die center.