

## ● Feature

- 20V/-3A,  $R_{DS(ON)} = 120\text{m}\Omega(\text{MAX}) @V_{GS} = -4.5\text{V}$ .
- $R_{DS(ON)} = 150\text{m}\Omega(\text{MAX}) @V_{GS} = -2.5\text{V}$ .
- Super High dense cell design for extremely low  $R_{DS(ON)}$
- Reliable and Rugged
- SOT-23 for Surface Mount Package

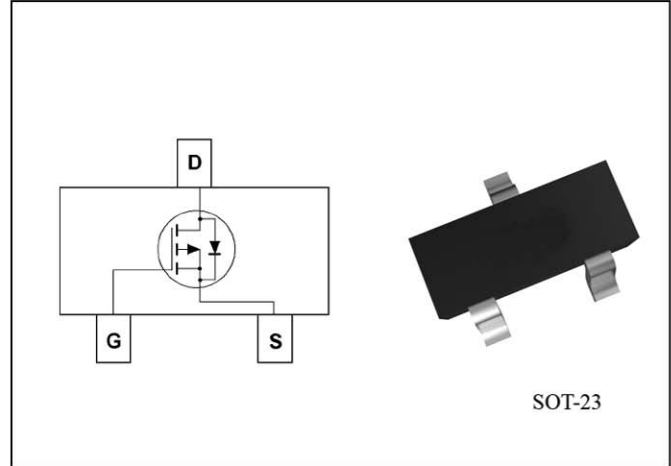

## ● Applications

- Power Management
- Portable Equipment and Battery Powered Systems.

## ● Absolute Maximum Ratings TA=25°C Unless Otherwise noted

Parameter	Symbol	Limit	Units
Drain-Source Voltage	$V_{DS}$	-20	V
Gate-Source Voltage	$V_{GS}$	±10	V
Drain Current-Continuous	$I_D$	-3	A

## ● Electrical Characteristics TA=25°C Unless Otherwise noted

Parameter	Symbol	Test Conditions	Min	Typ.	Max	Units
<b>Off Characteristics</b>						
Drain to Source Breakdown Voltage	BVDSS	$V_{GS}=0\text{V}, I_D=-250\mu\text{A}$	-20	-	-	V
Zero-Gate Voltage Drain Current	$I_{DSS}$	$V_{DS}=-20\text{V}, V_{GS}=0\text{V}$	-	-	-1	$\mu\text{A}$
Gate Body Leakage Current, Forward	$I_{GSSF}$	$V_{GS}=10\text{V}, V_{DS}=0\text{V}$	-	-	100	nA
Gate Body Leakage Current, Reverse	$I_{GSSR}$	$V_{GS}=-10\text{V}, V_{DS}=0\text{V}$	-	-	-100	nA
<b>On Characteristics</b>						
Gate Threshold Voltage	$V_{GS(th)}$	$V_{GS}=V_{DS}, I_D=-250\mu\text{A}$	-0.4	-	-1.0	V
Static Drain-source On-Resistance	$R_{DS(ON)}$	$V_{GS}=-4.5\text{V}, I_D=-3.0\text{A}$	-	--	120	$\text{m}\Omega$
		$V_{GS}=-2.5\text{V}, I_D=-2.0\text{A}$	-	--	150	$\text{m}\Omega$
<b>Drain-Source Diode Characteristics and Maximum Ratings</b>						
Drain-Source Diode Forward Voltage	VSD	$V_{GS}=0\text{V}, I_S=-1.25\text{A}$			-1.2	V

SK MAKE CONSCIOUS PRODUCT

CONSCIOUS PRODUCTS BEGIN WITH CONSCIOUS PEOPLE



## Typical Characteristics

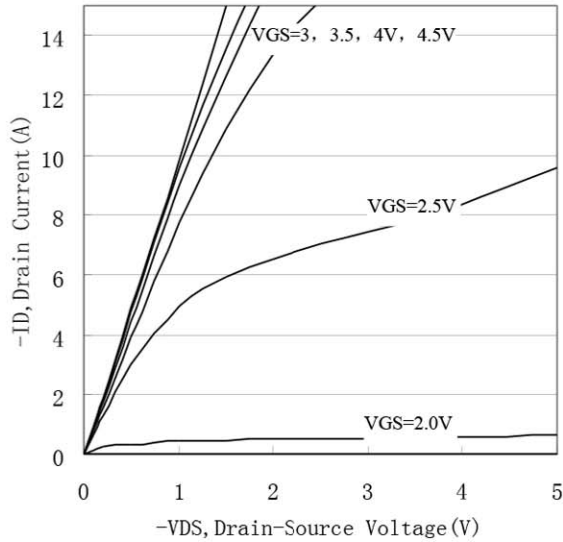

**Figure 1. Output Characteristics**

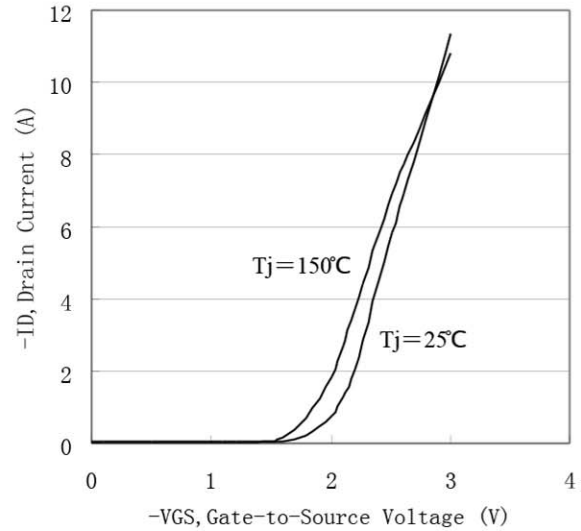

**Figure 2. Transfer Characteristics**

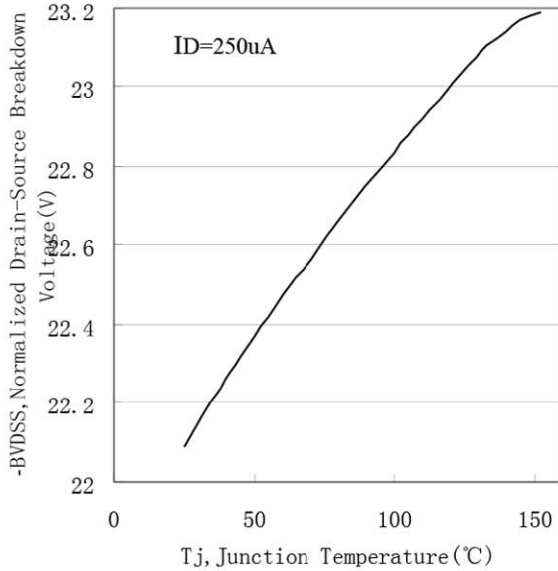

**Figure 3. Breakdown Voltage Variation with Temperature**

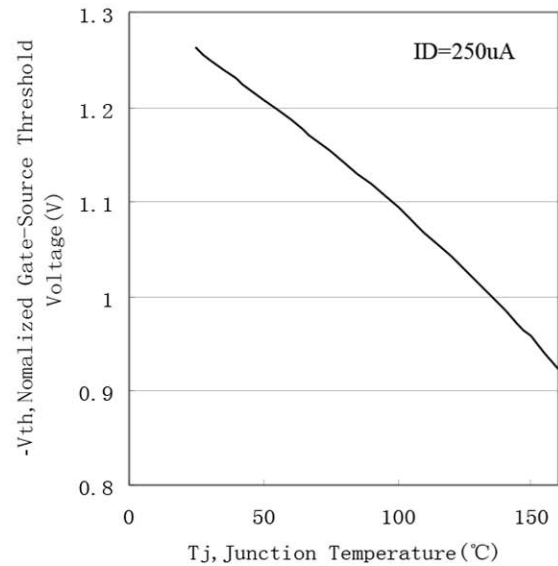

**Figure 4. Gate Threshold Variation with Temperature**



## Typical Characteristics

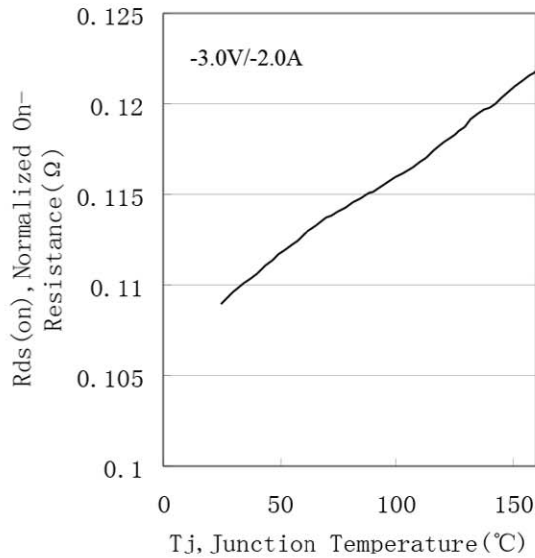

**Figure 5. On-Resistance Variation with Temperature**

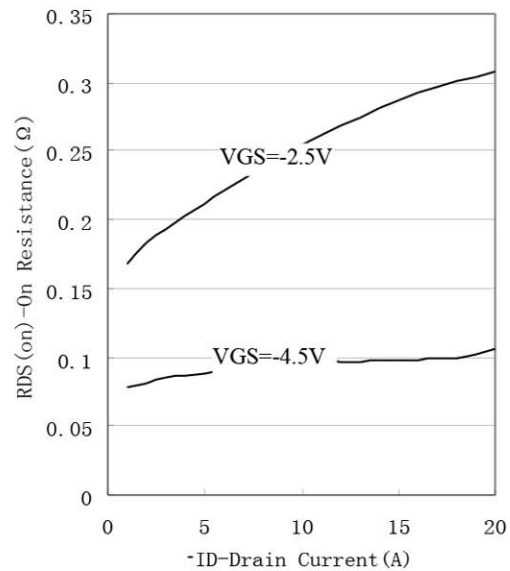

**Figure 6. On-Resistance vs. Drain Current**

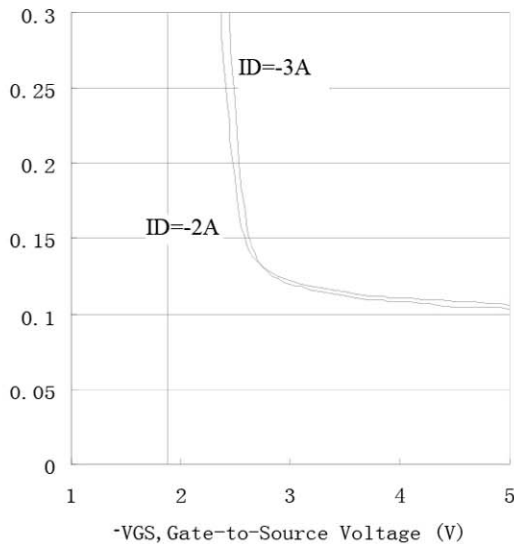

**Figure 7. On-Resistance vs. Gate-to-Source Voltage**

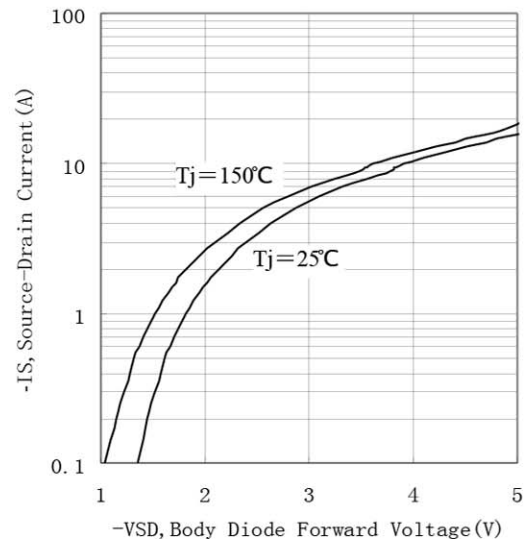

**Figure 8. Source-Drain Diode Forward**

SK MAKE CONSCIOUS PRODUCT

CONSCIOUS PRODUCTS BEGIN WITH CONSCIOUS PEOPLE



## Package Outline Dimensions (UNIT: mm)

### SOT-23

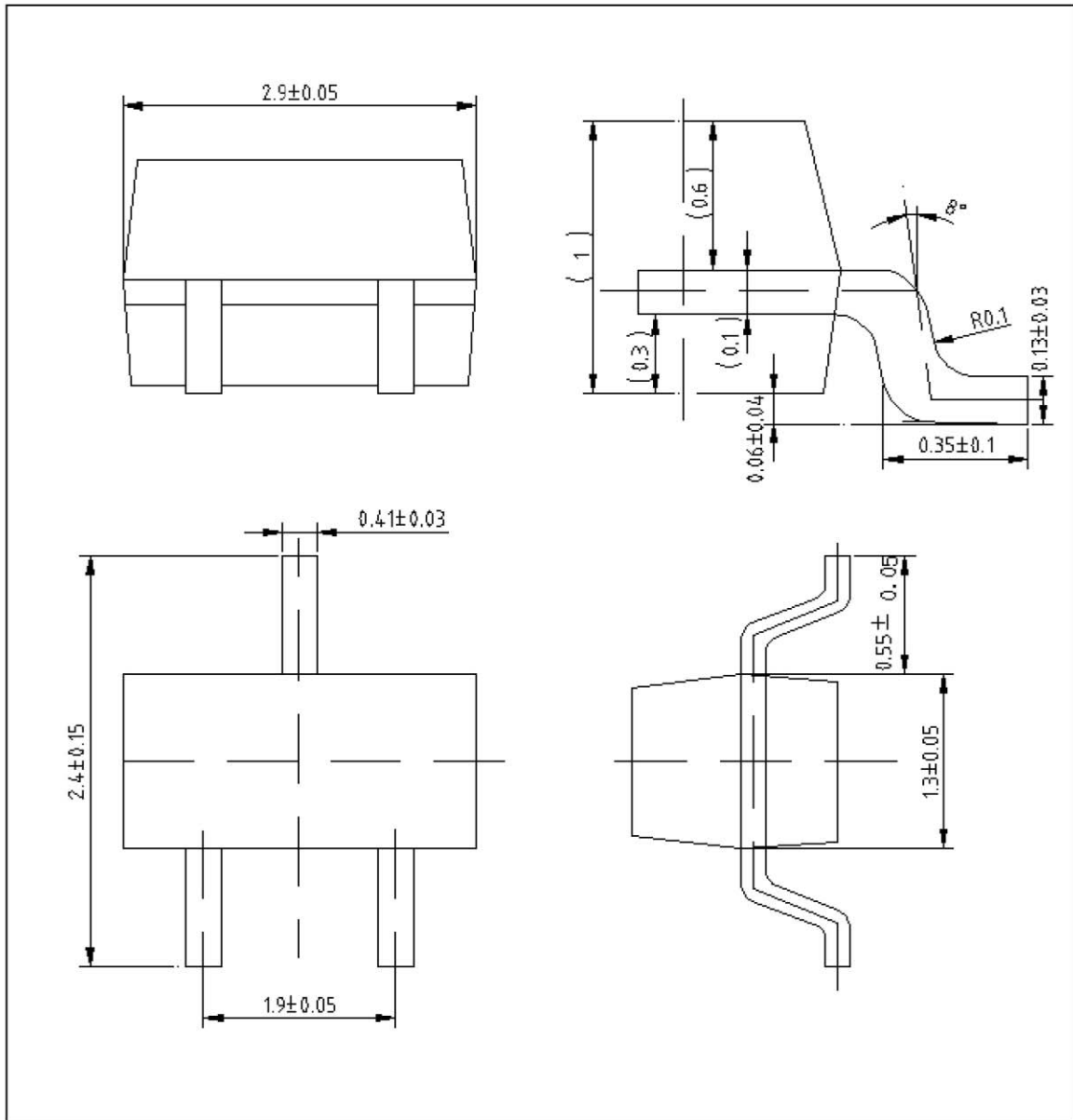

SK MAKE CONSCIOUS PRODUCT

CONSCIOUS PRODUCTS BEGIN WITH CONSCIOUS PEOPLE

