



DL100-23HA2103

Dx100

LONG RANGE DISTANCE SENSORS

SICK
Sensor Intelligence.



Illustration may differ



Ordering information

Type	Part no.
DL100-23HA2103	1052701

Other models and accessories → www.sick.com/Dx100

Detailed technical data

Performance

Measuring range	0.15 m ... 300 m, on reflective tape "Diamond Grade"
Resolution	0.1 mm, 0.125 mm, 1 mm, 10 mm, 100 mm
Repeatability	2 mm ¹⁾
Accuracy	± 3 mm ²⁾
Dead time	2 ms
Output time	Synchronous to PLC request (dependent on interfaces)
Light source	Laser, red ³⁾
Laser class	2 (EN 60825-1 / CDRH)
Typ. light spot size (distance)	5 mm (+ 2 mm x distance in m)
Max. movement speed	30 m/s
Acceleration (max.)	≤ 15 m/s ²
Internal measurement cycle	1 ms
Heating	✓

¹⁾ Statistical error 1 σ, environmental conditions constant, min. warm-up time 10 min.

²⁾ From 150 mm ... 180 mm measuring range the accuracy can reach ± 4 mm.

³⁾ Average service life: 100,000 h at T_U = +25 °C.

Interfaces

Switching output	B (push/pull), MF1, MF2 ¹⁾
Multifunctional input (MF)	1 x MF1 ²⁾
Data interface	RS-422

¹⁾ HIGH > V_S - 3 V / LOW < 2 V.

²⁾ HIGH > 12 V / LOW < 3 V.

Mechanics/electronics

Supply voltage V_s	DC 18 V ... 30 V, limit values
Ripple	5 V _{pp} ¹⁾
Initialization time	Typ. 1.5 s ²⁾
Housing material	Aluminum/zinc die-cast
Connection type	Male connector, M12, SPEEDCON™ compatible
Indication	6 digit 5 x 7 dot matrix display, LEDs
Weight	Approx. 800 g ... 1,600 g ³⁾
Output current I_A	≤ 100 mA ⁴⁾
Current consumption	At 24 V DC < 1,000 mA
Modulation frequency	Fix

¹⁾ May not fall short of or exceed V_s tolerances.

²⁾ After loss of reflector < 40 ms.

³⁾ Without mounting bracket: approx. 800 g, with mounting bracket: approx. 1,600 g.

⁴⁾ Short-circuit protected, overload-protected. Max. 100 nF / 20 mH.

Ambient data

Enclosure rating	IP 65
Protection class	III
Electromagnetic compatibility (EMC)	EN 61000-6-2, EN 61000-6-4 ¹⁾
Ambient temperature	Operation with heating: -40 °C ... +55 °C Operation with cooling case: -40 °C ... +75 °C Storage: -40 °C ... +75 °C
Effect of air pressure	0.3 ppm/hPa
Effect of air temperature	1 ppm/K
Temperature drift	Typ. 0.1 mm/K
Mechanical load	Shock: (EN 600 68-2-27) Sine: (EN 600 68-2-6) Noise: (EN 600 68-2-64)

¹⁾ This is a Class A device. This device can cause radio interference in living quarters.

DL100-23HA2103 | Dx100

LONG RANGE DISTANCE SENSORS

Dimensional drawing (Dimensions in mm (inch))

Dimensional drawing

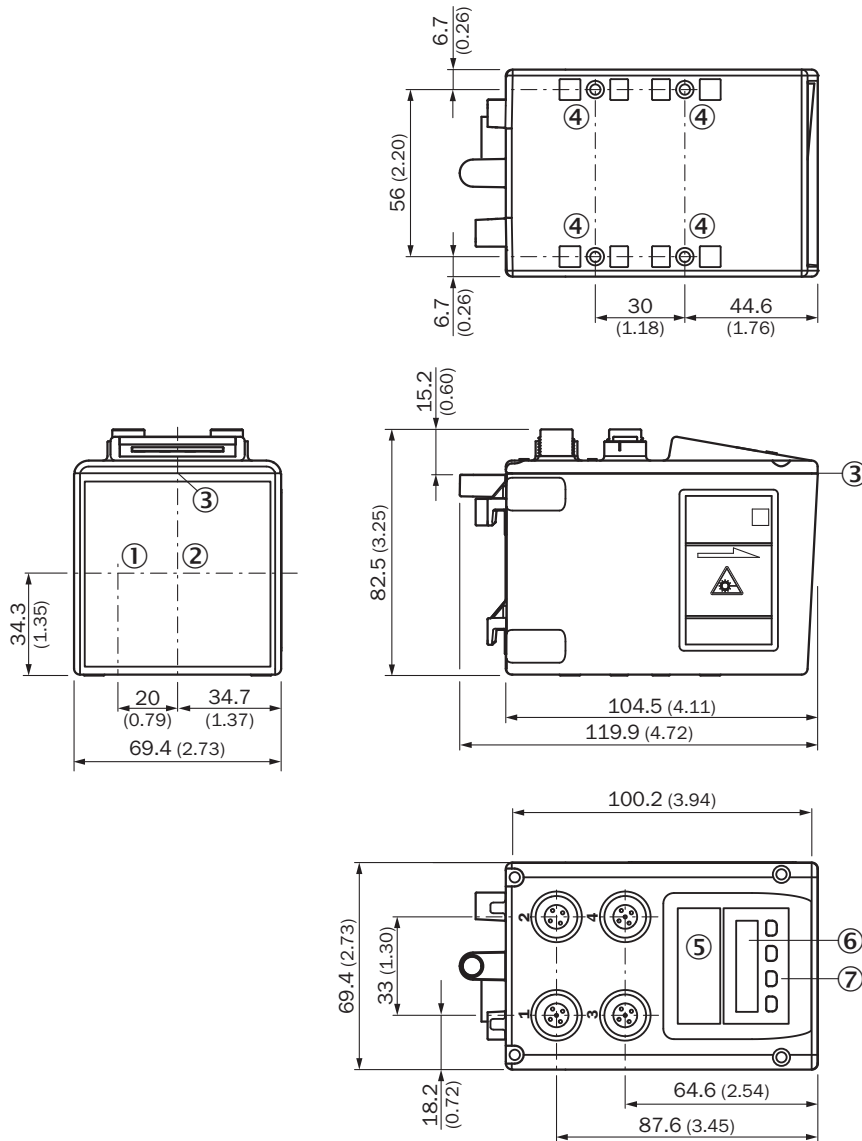

- ① Optical axis, sender
- ② Optical axis, receiver
- ③ Zero level
- ④ Threaded mounting hole M5
- ⑤ Status LED [status]
- ⑥ Display
- ⑦ Operating elements

Connection type

Dx100 Ethernet female connector, M12, 4-pin, D-coded

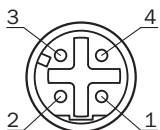

DL100 Pro SSI, M12 male connector, 8-pin, A-coded

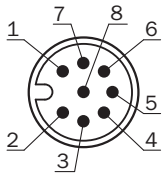

Connection diagram

DL100 Pro RS-422, SSI, M12 male connector, 8-pin

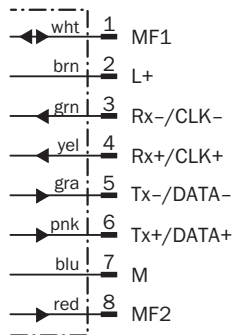

Ethernet M12 female connector, 4-pin

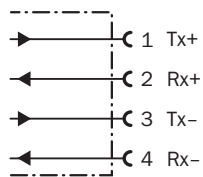

Adjustment possible



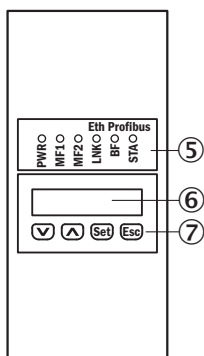



DL100-xxXXxx02



- ⑤ Status LED [status]
- ⑥ Display
- ⑦ Operating elements

Recommended accessories

Other models and accessories → www.sick.com/Dx100

	Brief description	Type	Part no.
Terminal and alignment brackets			
	Alignment unit for Dx100, incl. mounting material, steel, zinc coated	BEF-AH-DX100	2058653
Plug connectors and cables			
	Head A: female connector, M12, 8-pin, straight Head B: cable Cable: drag chain use, PUR, halogen-free, shielded, 5 m	DOL-1208-G05MAH1	6032449
	Head A: male connector, M12, 4-pin, straight, D-coded Head B: male connector, RJ45, 8-pin, straight Cable: PROFINET, drag chain use, PUR, shielded, 5 m CAT 5e	SSL-2J04-G05ME	6035389
Reflectors			
	Reflector plate, reflective tape "Diamond Grade", 665 mm x 665 mm, material base plate: aluminum, screw connection, Screw-on, 4 hole mounting	PL560DG	1016806
Sets and kits			
	Accessory kit for upgrade from DME3000 SSI/RS-422 to Dx100 SSI/RS-422	DME3000 Dx100 SSI/RS-422 upgrade kit	2065223
	Accessory kit for upgrade from DME4000/5000 SSI/RS-422 to Dx100 SSI/RS-422	DME4000/5000 Dx100 SSI/RS-422 upgrade kit	2065221

SICK AT A GLANCE

SICK is one of the leading manufacturers of intelligent sensors and sensor solutions for industrial applications. A unique range of products and services creates the perfect basis for controlling processes securely and efficiently, protecting individuals from accidents and preventing damage to the environment.

We have extensive experience in a wide range of industries and understand their processes and requirements. With intelligent sensors, we can deliver exactly what our customers need. In application centers in Europe, Asia and North America, system solutions are tested and optimized in accordance with customer specifications. All this makes us a reliable supplier and development partner.

Comprehensive services complete our offering: SICK LifeTime Services provide support throughout the machine life cycle and ensure safety and productivity.

For us, that is “Sensor Intelligence.”

WORLDWIDE PRESENCE:

Contacts and other locations –www.sick.com