

FEATURES

- Plastic package has Underwriters Laboratory Flammability Classification 94V-0
- Metal silicon junction ,majority carrier conduction
- Guard ring for overvoltage protection
- Low power loss ,high efficiency
- High current capability ,Low forward voltage drop
- High surge capability
- For use in low voltage ,high frequency inverters, free wheeling ,and polarity protection applications
- Dual rectifier construction
- High temperature soldering guaranteed:250°C/10 seconds, 0.25"(6.35mm)from case

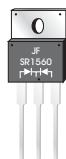

TO-220AB

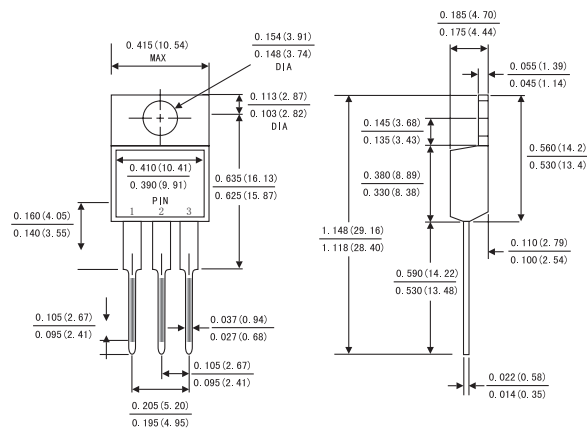

MECHANICAL DATA

- Case: JEDEC TO-220AB molded plastic body
- Terminals: Lead solderable per MIL-STD-750,method 2026
- Polarity: As marked, No suffix indicates Common Cathode, suffix"A" indicates Common Anode
- Mounting Position: Any
- Weight: 0.08ounce, 2.24 grams

Dimensions in inches and (millimeters)

MAXIMUM RATINGS AND ELECTRICAL CHARACTERISTICS

(Ratings at 25°C ambient temperature unless otherwise specified ,Single phase ,half wave ,resistive or inductive load. For capacitive load, derate by 20%.)

	Symbols	SR 1535	SR 1545	SR 1550	SR 1560	Units
Maximum repetitive peak reverse voltage	V_{RRM}	35	45	50	60	Volts
Maximum RMS voltage	V_{RMS}	25	32	35	42	Volts
Maximum DC blocking voltage	V_{DC}	35	45	50	60	Volts
Maximum average forward rectified current at $T_c=105^\circ\text{C}$ per diode/per device	$I(AV)$	7.5 15.0				Amps Amps
Repetitive peak forward current(square wave, 20KHZ) at $T_c=105^\circ\text{C}$ per diode	I_{FRM}	15.0				Amps
Peak forward surge current 8.3ms single half sine-wave superimposed on rated load (JEDEC method)	I_{FSM}	150.0				Amps
Maximum instantaneous forward voltage at 7.5 A(Note 1)	V_F	0.65		0.75		Volts
Maximum instantaneous reverse current at rated DC blocking voltage(Note 1)	$T_a=25^\circ\text{C}$	1.0				mA
	$T_a=125^\circ\text{C}$	15		50		
Typical thermal resistance (Note 2)	$R_{\theta JC}$	2.5				$^\circ\text{C/W}$
Operating junction temperature range	T_J	-65 to +150				$^\circ\text{C}$
Storage temperature range	T_{STG}	-65 to +175				$^\circ\text{C}$

- Notes: 1.Pulse test: 300 μs pulse width,1% duty cycle
2.Thermal resistance from junction to case

RATINGS AND CHARACTERISTIC CURVES SR1535 THRU SR1560

FIG.1-FORWARD CURRENT DERATING CURVE

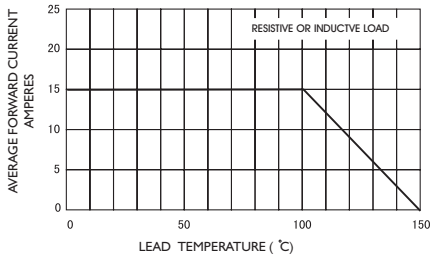

FIG.2-MAXIMUM NON-REPETITIVE PEAK FORWARD SURGE CURRENT

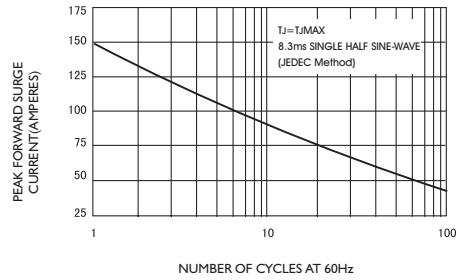

FIG.3-TYPICAL INSTANTANEOUS FORWARD CHARACTERISTICS

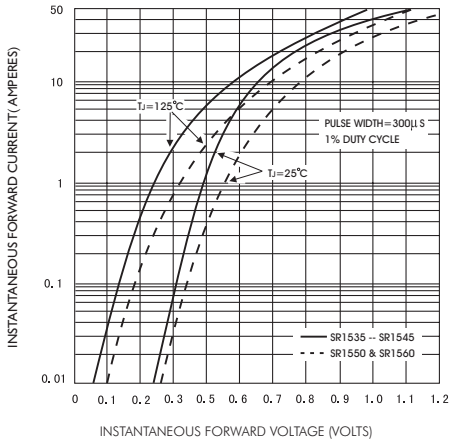

FIG.4-TYPICAL REVERSE CHARACTERISTICS

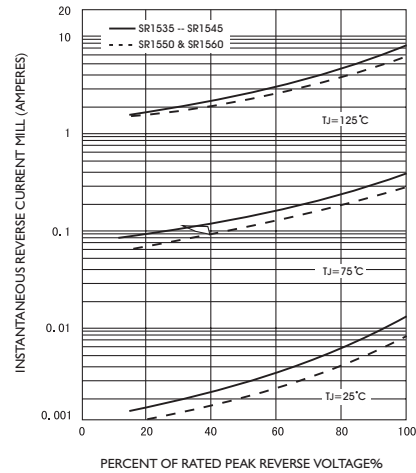

FIG.5-TYPICAL JUNCTION CAPACITANCE

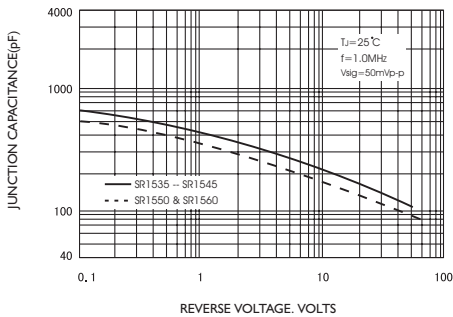

FIG.6-TYPICAL TRANSIENT THERMAL IMPEDANCE

