

POWER MANAGEMENT

Features

- Input Voltage Range – 1.1V to 3.6V
- 500mA Continuous Output Current
- Ultra-Low Ron – 90mΩ
- Automatic Output Discharge Circuit
 - Fast Turn-on Option With No Output Discharge Circuit – SC704
 - Extended Soft Start Option With Automatic Output Discharge Circuit – SC705
- Low Shutdown Quiescent Current
- Hardened ESD Protection 5kV
- Package: CSP – 0.76mm × 0.76mm, 0.4mm Pitch

Description

The SC704/SC705 is a low input voltage, low Ron load switch, designed for use in battery powered applications. Integrated circuitry controls the switch to minimize resistance over a wide range of conditions.

The device provides controlled soft-start to limit inrush current. The SC705 features an automatic discharge circuit which discharges the output when the part is disabled.

The SC704/SC705 is offered in an ultra-small 4-bump 0.76mm×0.76mm Chip Scale Package (CSP) which enables very small board area implementations. The SC704/SC705 has an operating temperature range of -40°C to +85°C.

Applications

- Smart Phones
- Tablet PCs
- GPS devices
- Battery powered equipment
- Other portable Device

Device	Package	Automatic Discharge	Rising Time
SC704	CSP	No	6.7μs(Typ.)
SC705	CSP	Yes	137μs(Typ.)

Typical Application Circuit

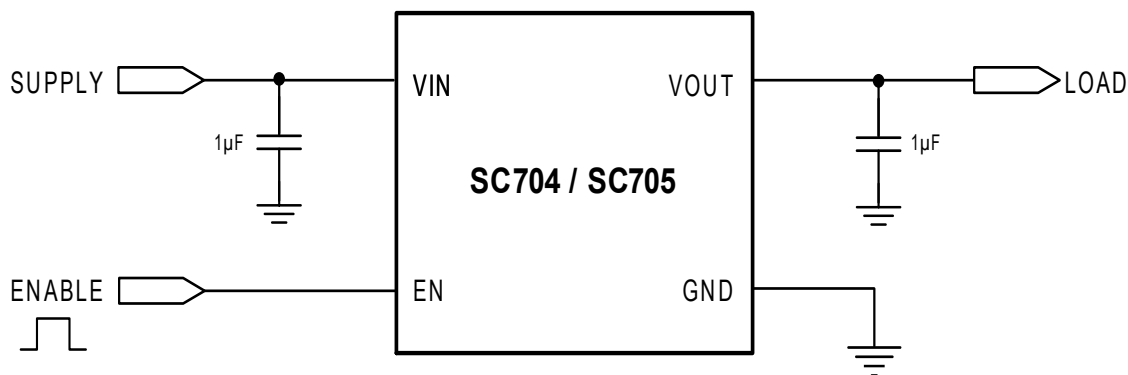

Pin Configuration

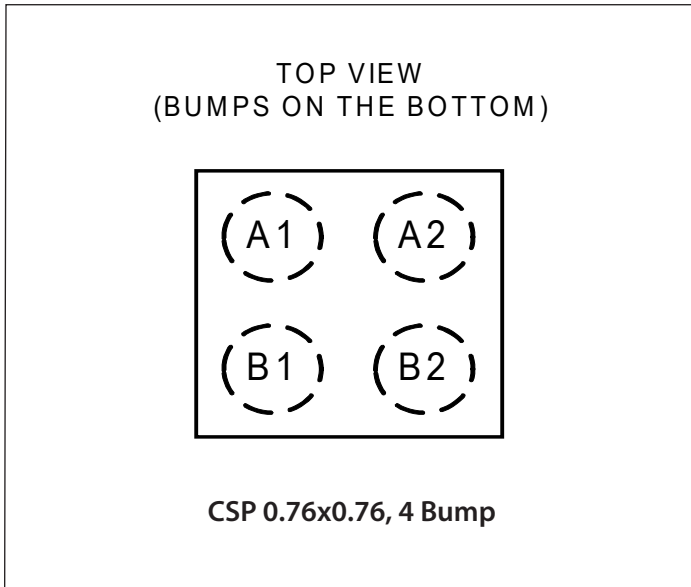

Ordering Information

Device	Package
SC704CSTRT	CSP 0.76mm×0.76mm 4-bump
SC705CSTRT	CSP 0.76mm×0.76mm 4-bump
SC704EVB	Evaluation Board
SC705EVB	Evaluation Board

Notes:

- (1) Available in tape and reel only. A reel contains 5,000 devices.
- (2) Lead-free packaging only. Device is WEEE and RoHS compliant, and halogen free.

Marking Information

SC704

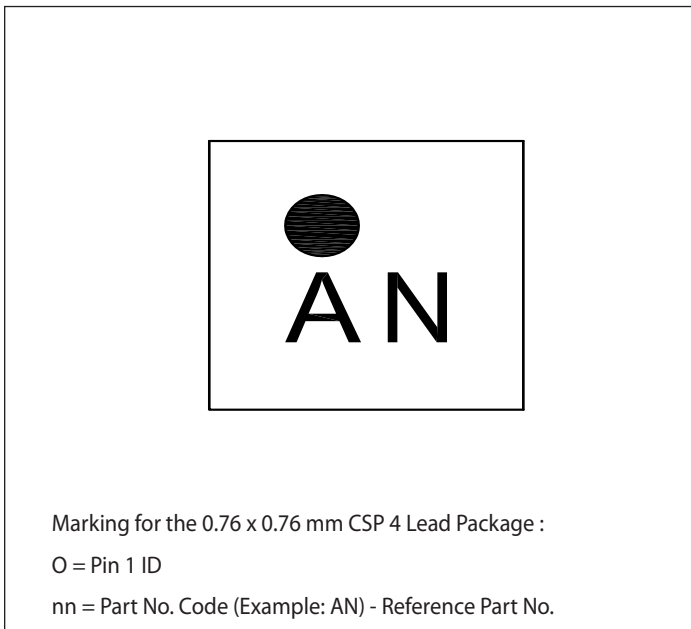

SC705

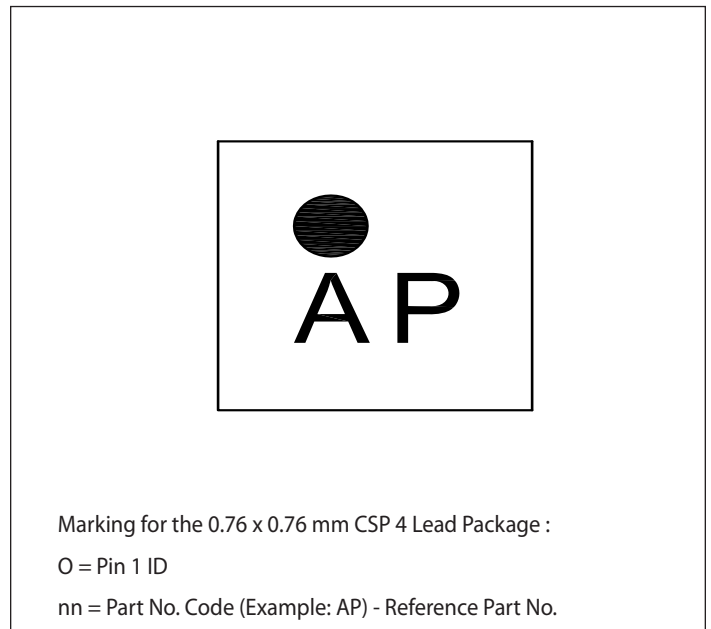

Absolute Maximum Ratings

VIN to GND	-0.3Vto+4.3V
EN to GND	-0.3Vto+4.3V
OUT to GND	-0.3V to +V _{VIN}
ESD Protection Level ⁽¹⁾ (kV)	5

Recommended Operating Conditions

Ambient Temperature Range (°C)	$-40 \leq T_A \leq +85$
V _{VIN} (V).....	1.1 to 3.6
CIN Input Capacitance = 1uF	

Thermal Information

Thermal Resistance, Junction to Ambient ⁽²⁾ (°C/W) ...	160
Maximum Junction Temperature (°C)	+125
Storage Temperature Range (°C).....	-65 to +150
Peak IR Reflow Temperature (10s to 30s) (°C)	+260

Exceeding the above specifications may result in permanent damage to the device or device malfunction. Operation outside of the parameters specified in the Electrical Characteristics section is not recommended.

NOTES:

- (1) Tested according to JEDEC standard JESD22-A114-B.
- (2) Assumes 3 x 4.5 inch, 4 layer FR4 PCB per JESD51 with 4 mil (100 micron) width traces connected to ball pads.

Electrical Characteristics

Unless otherwise noted V_{IN} = 1.8V, C_{IN} = 1μF, C_{OUT} = 1μF, V_{EN} = V_{VIN}, T_A = -40°C to +85°C. Typical values are at T_A = 25°C.

Parameter	Symbol	Conditions	Min	Typ	Max	Units	
Input Supply Voltage Range	V _{IN}		1.1		3.6	V	
Output Voltage	V _{OUT}				V _{IN}	V	
Maximum Output Current	I _{MAX}	Continuous current	500			mA	
On Resistance (Ron)	R _{ON}	V _{IN} =3.6V, I _{OUT} =200mA, V _{EN} =1.5V		64		mΩ	
		V _{IN} =2.5V, I _{OUT} =200mA, V _{EN} =1.5V		72		mΩ	
		V _{IN} =1.8V, I _{OUT} =200mA, V _{EN} =1.5V		90	130	mΩ	
		V _{IN} =1.5V, I _{OUT} =200mA, V _{EN} =1.5V			98		mΩ
		V _{IN} =1.2V, I _{OUT} =200mA, V _{EN} =1.0V			126		mΩ
Shutdown Current	I _{SD}	V _{EN} =0V, V _{OUT} open, T _A = 25°C		0.1		μA	
		V _{EN} =0V, -40°C ≤ T _A ≤ 85°C			2	μA	
Quiescent Current	I _Q ⁽¹⁾	V _{IN} =V _{EN} =3.6V, V _{OUT} open, -40°C ≤ T _A ≤ 85°C			2	μA	
Enable							
EN Input High Threshold	V _{IH}		1.1			V	
ENABLE Input Low Threshold	V _{IL}				0.3	V	

Electrical Characteristics (continued)

Parameter	Symbol	Conditions	Min	Typ	Max	Units
EN Input Pull-Down Resistance	R_{EN}			5		$M\Omega$
SC704						
Turn-on Delay Time	T_{DT}	$V_{IN}=1.8V, I_{OUT}=200mA, V_{EN}=1.5V$		5		μs
		$V_{IN}=3.6V, I_{OUT}=200mA, V_{EN}=1.5V$		1.5		μs
Rising Time	T_{RT}	$V_{IN}=1.8V, I_{OUT}=200mA, V_{EN}=1.5V$		6.7		μs
Falling Time	T_{FT}	$V_{IN}=1.8V, I_{OUT}=500mA, V_{EN}=1.5V$		3.7		μs
SC705						
Turn-on Delay Time	T_{DT}	$V_{IN}=1.8V, I_{OUT}=200mA, V_{EN}=1.5V$		100		μs
		$V_{IN}=3.6V, I_{OUT}=200mA, V_{EN}=1.5V$		50		μs
Rising Time	T_{RT}	$V_{IN}=1.8V, I_{OUT}=200mA, V_{EN}=1.5V$		137		μs
Falling Time	T_{FT}	$V_{IN}=1.8V, I_{OUT}=500mA, V_{EN}=1.5V$		7.2		μs
Output Pull-Down Resistance	R_{PD}	$V_{IN}=1.8V$		220		Ω

Notes:

(1) I_Q current includes EN pull-down current.

Typical Characteristics (SC704)

Start Up by VIN

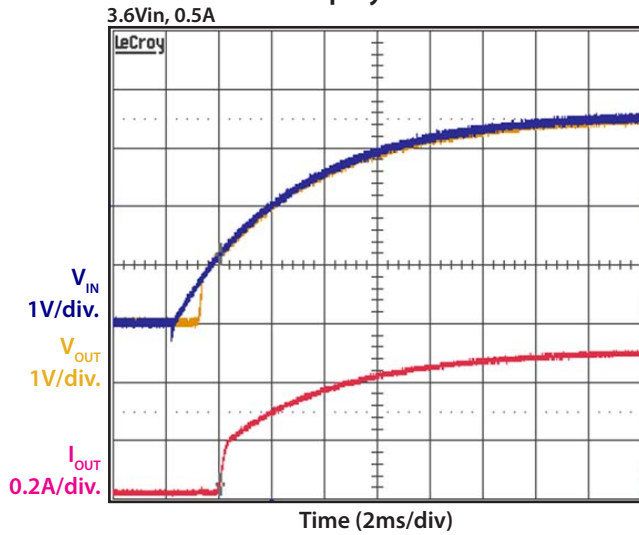

Shutdown by VIN

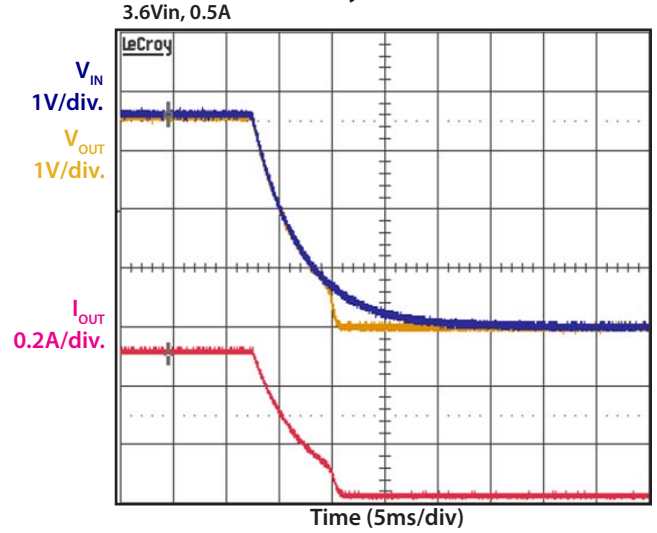

Start up by EN

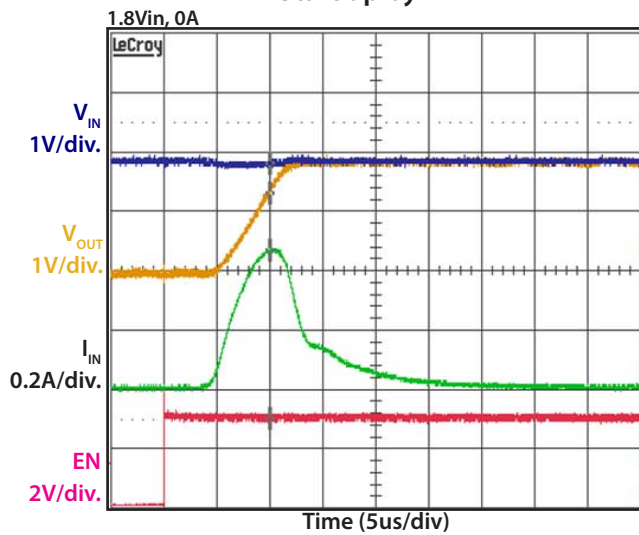

Start up by EN

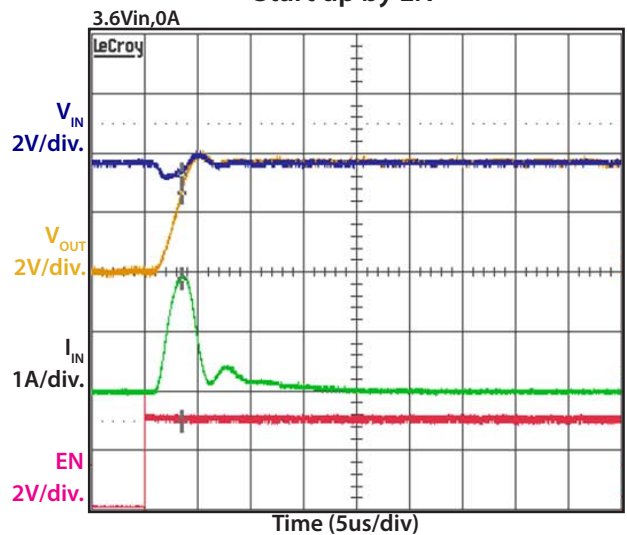

Shutdown by EN

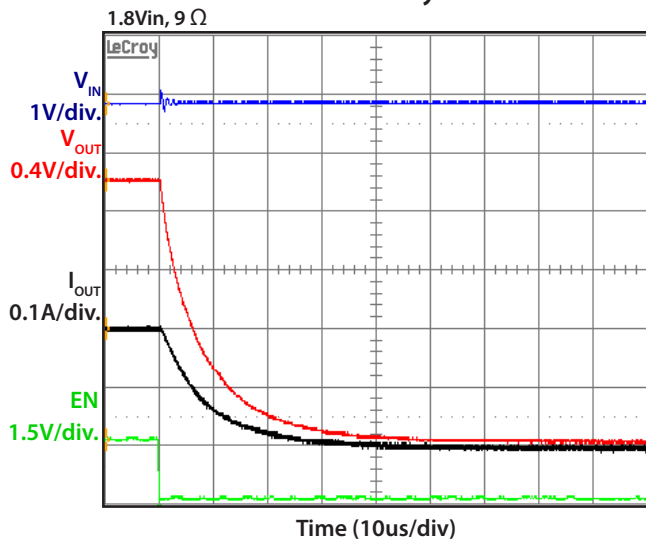

Typical Characteristics (SC705)

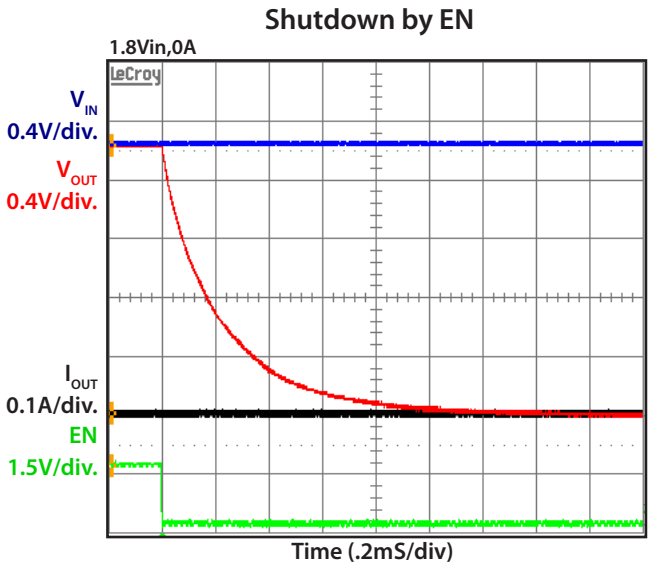
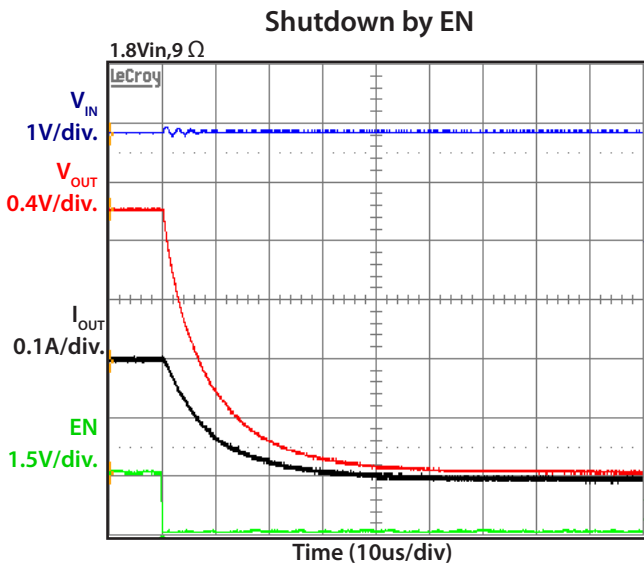
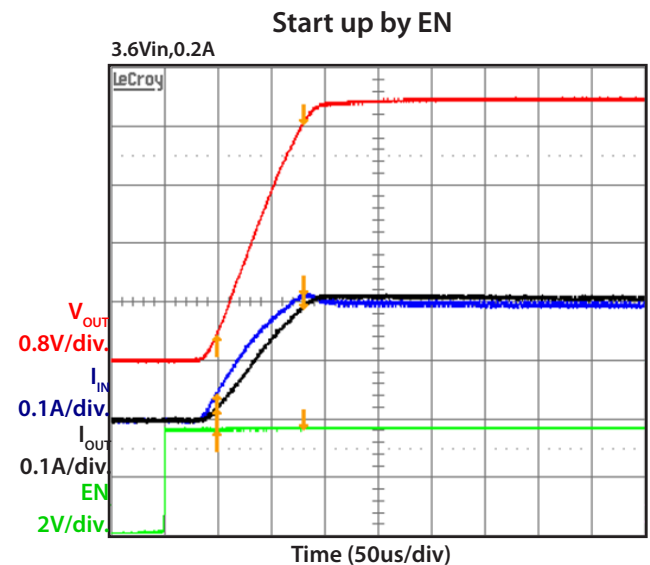
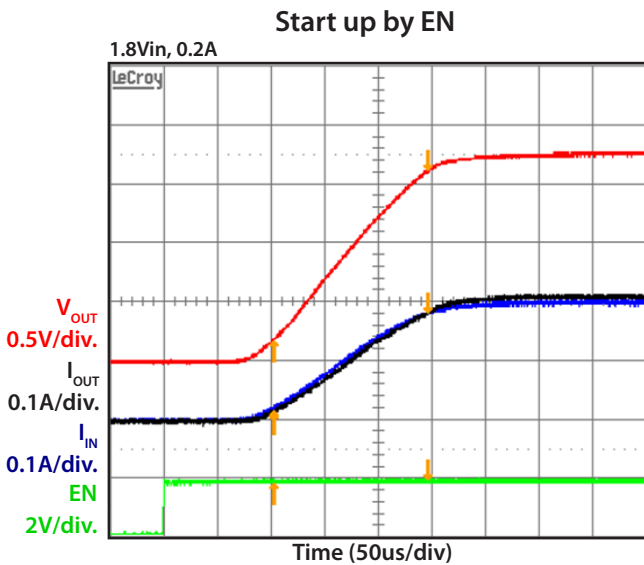
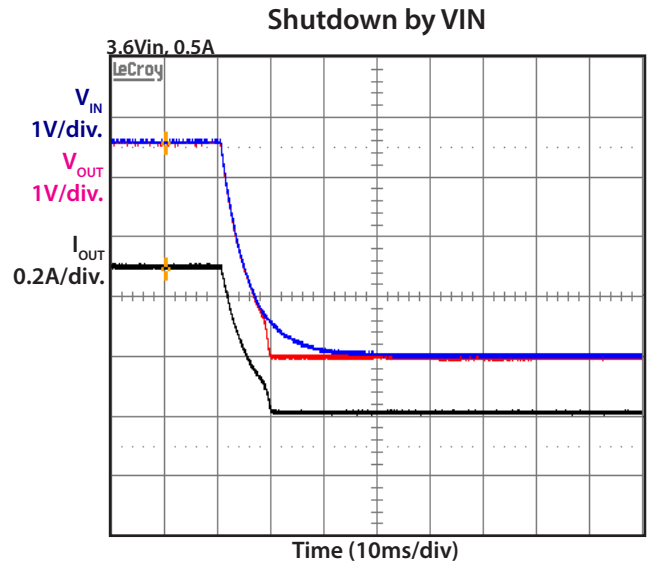
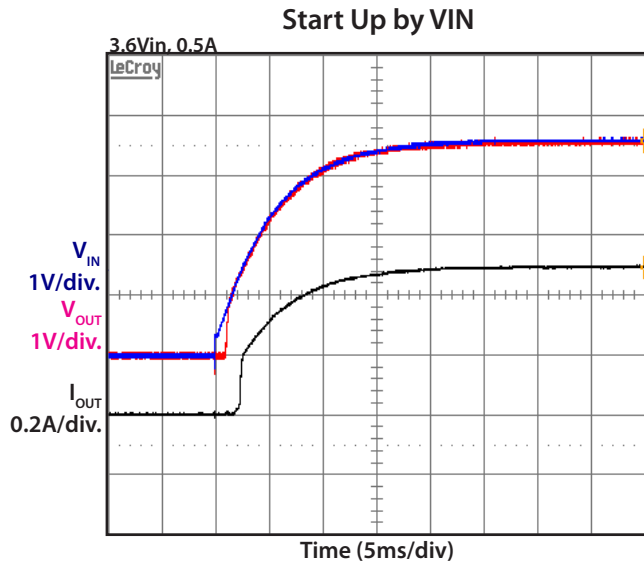

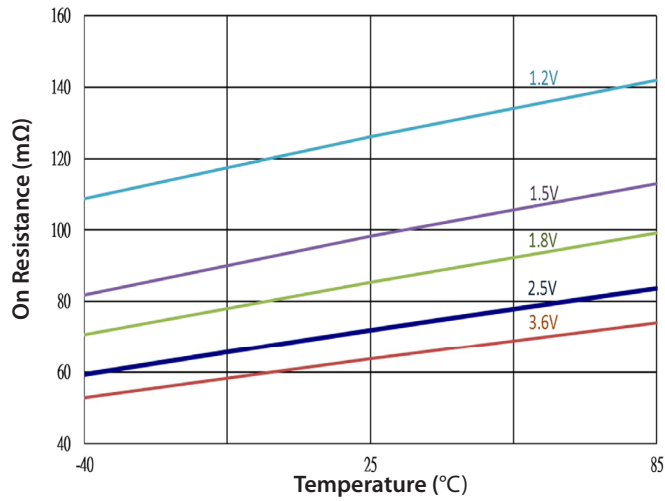
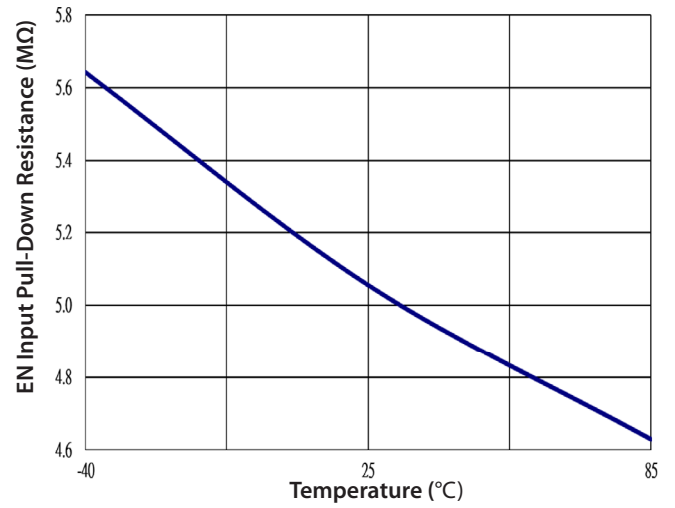
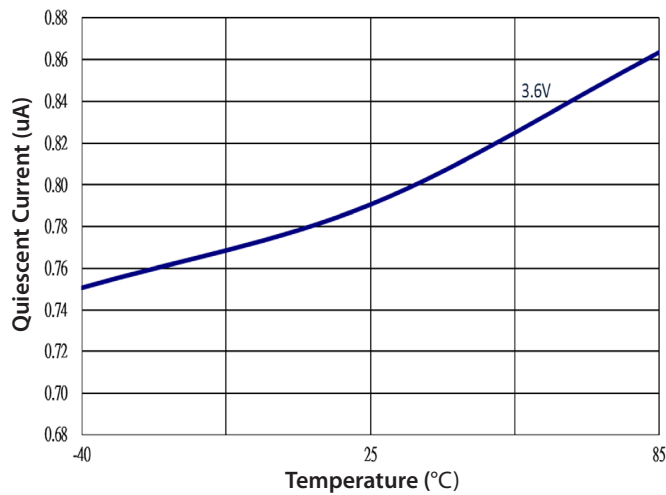
Typical Characteristics, Cont.
On Resistance vs. Temperature

EN Input Pull-Down Resistance vs. Temperature

Quiescent Current vs. Temperature

Pin Descriptions

Pin #	Pin Name	Pin Function
A1	VIN	Input supply voltage.
B1	EN	Enable input. Drive high to turn on the switch; drive low to turn off the switch. Floating is low. A 5MΩ internal resistor is connected to GND. In SC705 the EN input engages the automatic discharge function when the input is at logic Low.
A2	OUT	Output voltage.
B2	GND	Ground.

Timing Diagram

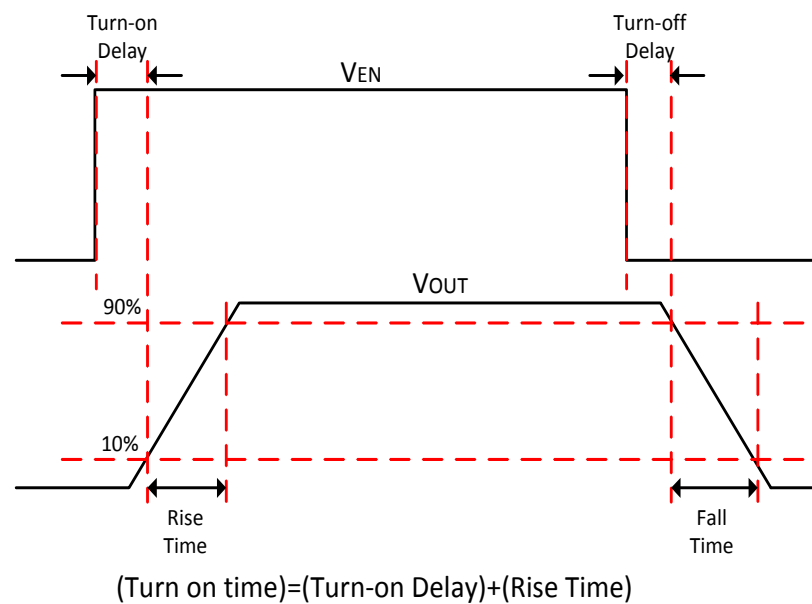
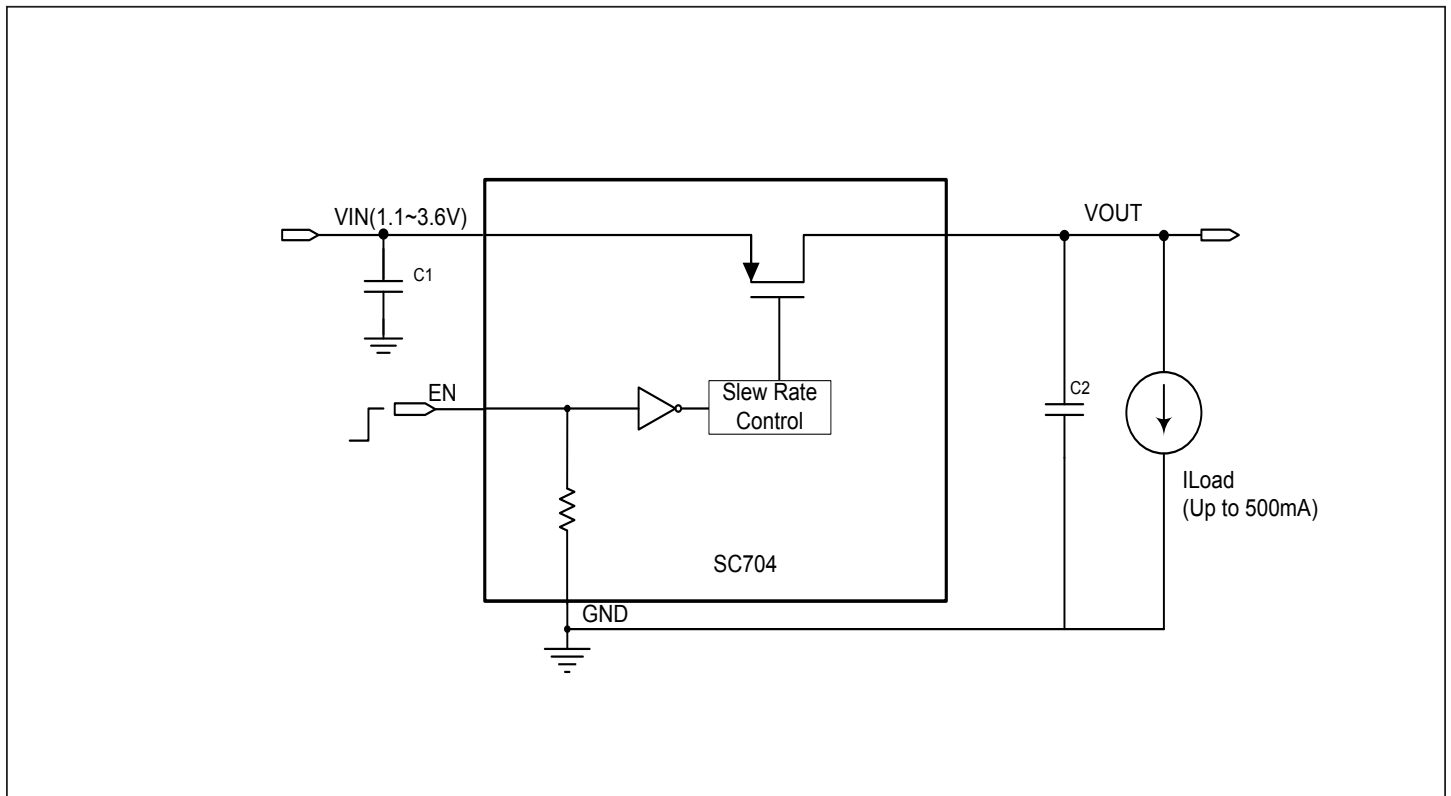
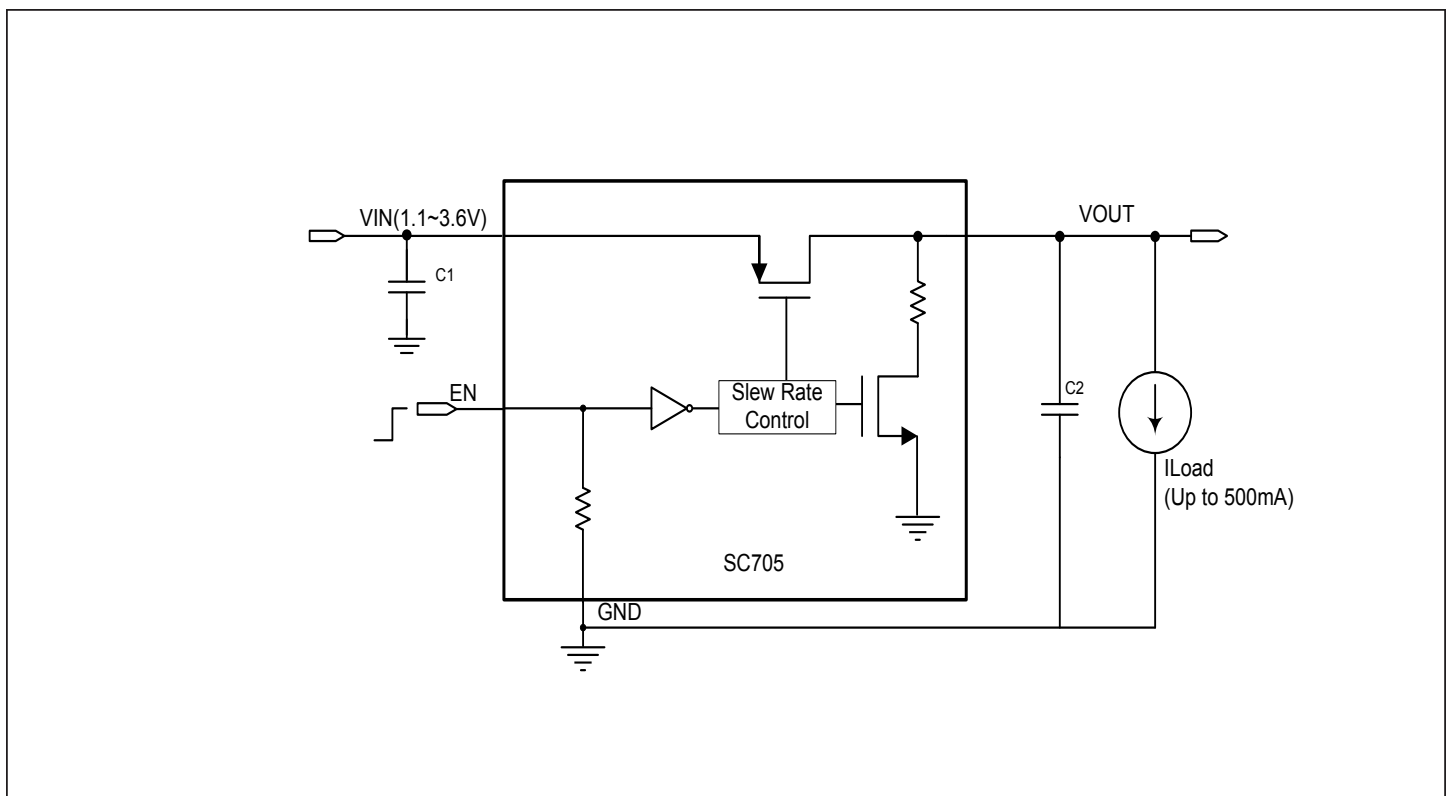

Figure 1

Block Diagram
SC704

SC705



Application Information

Operation

The SC704/SC705 are integrated high-side PMOS load switches that are designed to support up to 500mA continuous output current and operate from an input voltage between 1.1V to 3.6V. The internal PMOS pass element has a very low on resistance of 90m Ω (typical) at 1.8V. The Enable pin incorporates a 5M Ω (typical) pull-down resistor. The SC704/SC705 also provides ultra-low low shutdown and quiescent current for extended battery life during shutdown and light loading conditions.

The SC705 includes an automatic output discharge function which employs a 220 Ω (typical) discharge path to ground when the EN pin is disabled. The SC705 is also designed for longer output rise time to decrease input inrush current during power on.

Enable

The gate of the internal PMOS FET of SC704/SC705 is controlled by EN pin logic circuitry. If the EN pin is floating, the internal switch will be turned off. In SC705 the EN pin also controls the automatic discharge function.

Input Capacitor

In order to improve voltage drop, noise and bounce on VIN pin, a filter/decoupling capacitor between VIN to GND is recommended. A 1 μ f ceramic capacitor will be sufficient for most application conditions. However it should be noted that suppressing bounce on input loop after EN from high to low can require greater capacitor values depending on the particular design being implemented. During certain shutdown conditions, as in the case when input power supply is abruptly removed, the input voltage may tend to drop faster than the output voltage. In this event a reverse current through the body diode of internal PMOS FET from VOUT to VIN can occur. To limit this reverse current, C_{in} should be made greater than C_{out} to sink current from the output.

Output Capacitor

A 1 μ F filter capacitor is added on the VOUT pin to suppress noise on the evaluation board. If a larger output capacitance value is used, then input inrush current should be considered since the power-on transient is dependent on the output capacitor size. It should also be noted that SC705 has longer turn-on delay time and rise

time than SC704 so SC705 will significantly improve input inrush current during power-on application conditions.

Board Layout Considerations

Input capacitor(C1) and output capacitor(C2) should be placed as close to the SC704/SC705 as possible, and all traces should be as short as possible and as wide as possible to minimize the case-to-ambient thermal impedance and parasitic electrical effects.

Evaluation Board Information

Both T1 and T2 test points are Kelvin connections which can be used to minimize R_o. A jumper can be used between VIN and EN on J1 to enable the part. To disable the part the jumper can be connected between EN and GND on J1.

Top Layer

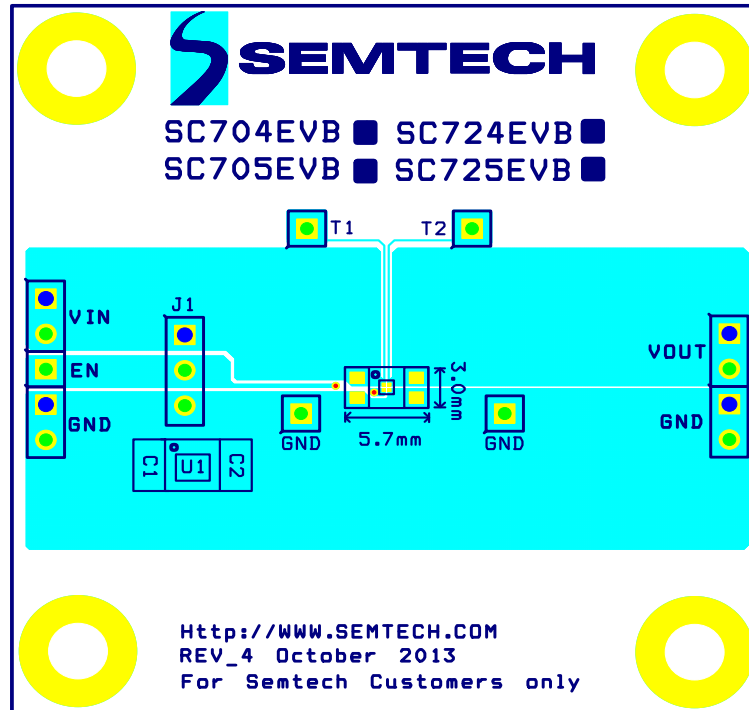

Figure 2

Bottom Layer

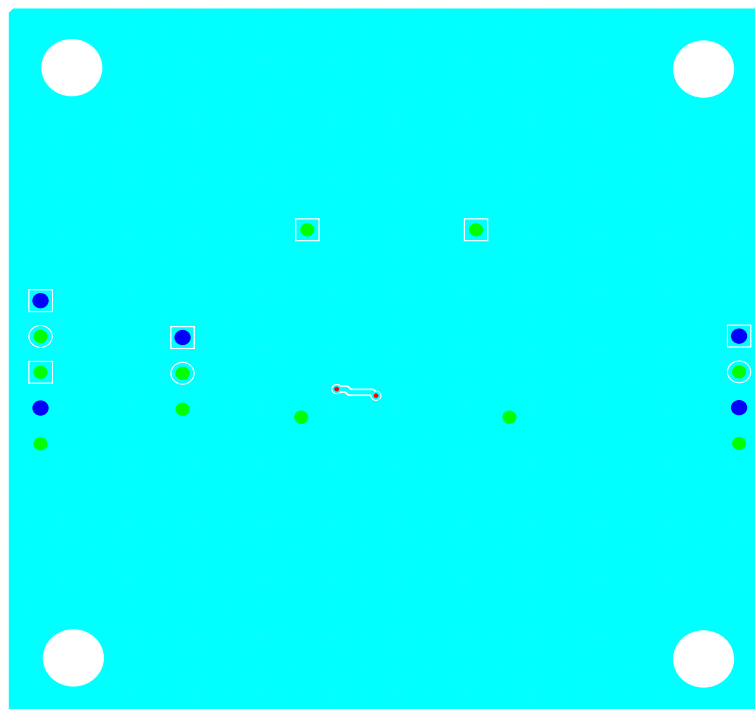
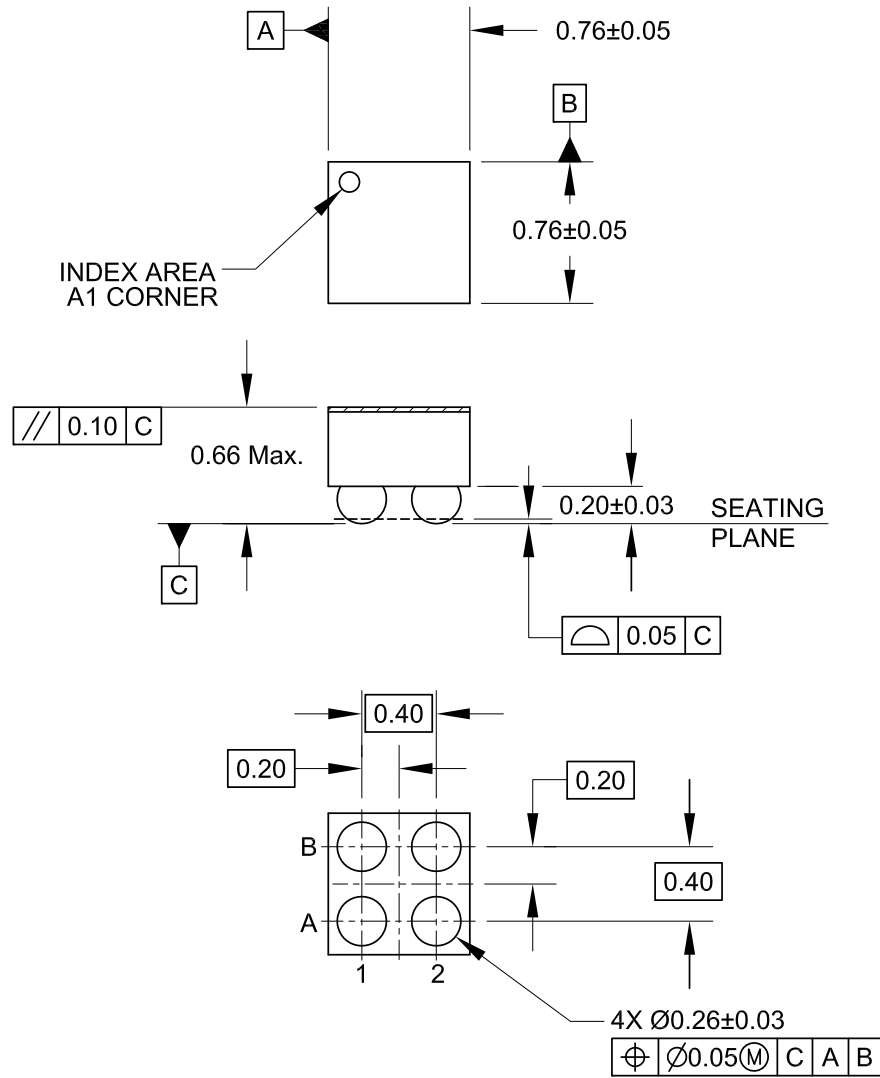
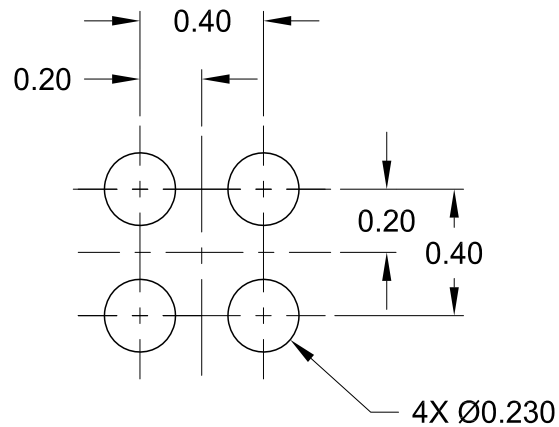

Figure 3

Outline Drawing — CSP 0.76mm X 0.76mm, 4 Lead

NOTES:

1. CONTROLLING DIMENSIONS ARE IN MILLIMETERS

Land Pattern — CSP 0.76mm X 0.76mm, 4 Lead

NOTES:

1. CONTROLLING DIMENSIONS ARE IN MILLIMETERS
2. THIS LAND PATTERN IS FOR REFERENCE PURPOSES ONLY.
CONSULT YOUR MANUFACTURING GROUP TO ENSURE YOUR
COMPANY'S MANUFACTURING GUIDELINES ARE MET.

© Semtech 2015

All rights reserved. Reproduction in whole or in part is prohibited without the prior written consent of the copyright owner. The information presented in this document does not form part of any quotation or contract, is believed to be accurate and reliable and may be changed without notice. No liability will be accepted by the publisher for any consequence of its use. Publication thereof does not convey nor imply any license under patent or other industrial or intellectual property rights. Semtech assumes no responsibility or liability whatsoever for any failure or unexpected operation resulting from misuse, neglect improper installation, repair or improper handling or unusual physical or electrical stress including, but not limited to, exposure to parameters beyond the specified maximum ratings or operation outside the specified range.

SEMTECH PRODUCTS ARE NOT DESIGNED, INTENDED, AUTHORIZED OR WARRANTED TO BE SUITABLE FOR USE IN LIFE-SUPPORT APPLICATIONS, DEVICES OR SYSTEMS OR OTHER CRITICAL APPLICATIONS. INCLUSION OF SEMTECH PRODUCTS IN SUCH APPLICATIONS IS UNDERSTOOD TO BE UNDERTAKEN SOLELY AT THE CUSTOMER'S OWN RISK. Should a customer purchase or use Semtech products for any such unauthorized application, the customer shall indemnify and hold Semtech and its officers, employees, subsidiaries, affiliates, and distributors harmless against all claims, costs damages and attorney fees which could arise.

Notice: All referenced brands, product names, service names and trademarks are the property of their respective owners.

Contact Information

Semtech Corporation
Power Management Products Division
200 Flynn Road, Camarillo, CA 93012
Phone: (805) 498-2111 Fax: (805) 498-3804

www.semtech.com