

Insulated Gate Bipolar Transistor with Ultrafast Soft Recovery Diode

$V_{CES} = 600V$
$I_C = 160A, T_C = 100^\circ C$
$t_{SC} \geq 5\mu s, T_{J(max)} = 175^\circ C$
$V_{CE(ON)} \text{ typ.} = 1.65V @ I_C = 120A$

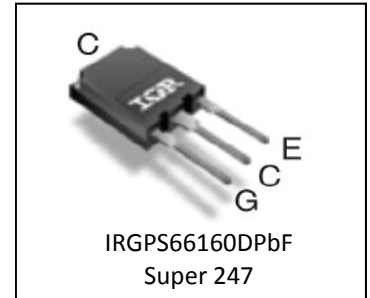
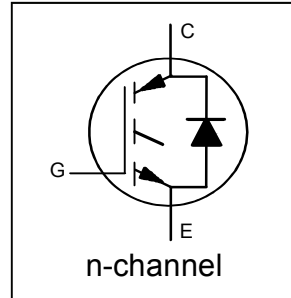

G	C	E
Gate	Collector	Emitter

Applications

- Welding
- H Bridge Converters

Features	Benefits
Low $V_{CE(ON)}$ and Switching Losses	High Efficiency in a Wide Range of Applications
Optimized Diode for Full Bridge Hard Switch Converters	Optimized for Welding and H Bridge Converters
Square RBSOA and Maximum Temperature of $175^\circ C$	Improved Reliability due to Rugged Hard Switching Performance and High Power Capability
$5\mu s$ Short Circuit	Enables Short Circuit Protection Operation
Positive $V_{CE(ON)}$ Temperature Co-efficient	Excellent Current Sharing in Parallel Operation
Lead-free, RoHS compliant	Environmentally friendly

Base part number	Package Type	Standard Pack		Orderable Part Number
		Form	Quantity	
IRGPS66160DPbF	Super 247	Tube	25	IRGPS66160DPbF

Absolute Maximum Ratings

	Parameter	Max.	Units
V_{CES}	Collector-to-Emitter Voltage	600	V
$I_C @ T_C = 25^\circ C$	Continuous Collector Current	240	A
$I_C @ T_C = 100^\circ C$	Continuous Collector Current	160	
I_{CM}	Pulse Collector Current, $V_{GE} = 15V$	360	
I_{LM}	Clamped Inductive Load Current, $V_{GE} = 20V$ ①	480	
$I_{FRM} @ T_C = 100^\circ C$	Diode Repetitive Peak Forward Current④⑥	80	
I_{FM}	Diode Maximum Forward Current ④	480	W
V_{GE}	Continuous Gate-to-Emitter Voltage	± 20	
$P_D @ T_C = 25^\circ C$	Maximum Power Dissipation	750	W
$P_D @ T_C = 100^\circ C$	Maximum Power Dissipation	375	
T_J T_{STG}	Operating Junction and Storage Temperature Range	-40 to +175	$^\circ C$
	Soldering Temperature, for 10 sec.	300 (0.063 in. (1.6mm) from case)	

Thermal Resistance

	Parameter	Min.	Typ.	Max.	Units
$R_{\theta JC}$ (IGBT)	Thermal Resistance Junction-to-Case-(each IGBT) ②	—	—	0.20	$^\circ C/W$
$R_{\theta JC}$ (Diode)	Thermal Resistance Junction-to-Case-(each Diode) ②	—	—	1.37	
$R_{\theta CS}$	Thermal Resistance, Case-to-Sink (flat, greased surface)	—	0.24	—	
$R_{\theta JA}$	Thermal Resistance, Junction-to-Ambient (typical socket mount)	—	—	40	

Electrical Characteristics @ T_J = 25°C (unless otherwise specified)

	Parameter	Min.	Typ.	Max.	Units	Conditions
V _{(BR)CES}	Collector-to-Emitter Breakdown Voltage	600	—	—	V	V _{GE} = 0V, I _C = 100μA ③
ΔV _{(BR)CES} /ΔT _J	Temperature Coeff. of Breakdown Voltage	—	0.54	—	V/°C	V _{GE} = 0V, I _C = 4.0mA (25°C-175°C)
V _{CE(on)}	Collector-to-Emitter Saturation Voltage	—	1.65	1.95	V	I _C = 120A, V _{GE} = 15V, T _J = 25°C
		—	1.95	—		I _C = 120A, V _{GE} = 15V, T _J = 150°C
		—	2.0	—		I _C = 120A, V _{GE} = 15V, T _J = 175°C
V _{GE(th)}	Gate Threshold Voltage	4.0	—	6.5	V	V _{CE} = V _{GE} , I _C = 5.6mA
ΔV _{GE(th)} /ΔT _J	Threshold Voltage Temperature Coeff.	—	-16	—	mV/°C	V _{CE} = V _{GE} , I _C = 5.6mA (25°C-175°C)
g _{fe}	Forward Transconductance	—	86	—	S	V _{CE} = 50V, I _C = 120A, PW = 20μs
I _{CES}	Collector-to-Emitter Leakage Current	—	1.0	150	μA	V _{GE} = 0V, V _{CE} = 600V
		—	2000	—		V _{GE} = 0V, V _{CE} = 600V, T _J = 175°C
I _{GES}	Gate-to-Emitter Leakage Current	—	—	±400	nA	V _{GE} = ±20V
V _F	Diode Forward Voltage Drop	—	1.80	2.60	V	I _F = 24A
		—	1.30	—		I _F = 24A, T _J = 175°C

Switching Characteristics @ T_J = 25°C (unless otherwise specified)

	Parameter	Min.	Typ.	Max	Units	Conditions
Q _g	Total Gate Charge (turn-on)	—	220	—	nC	I _C = 120A V _{GE} = 15V V _{CC} = 400V
Q _{ge}	Gate-to-Emitter Charge (turn-on)	—	60	—		
Q _{gc}	Gate-to-Collector Charge (turn-on)	—	90	—		
E _{on}	Turn-On Switching Loss	—	4470	—	μJ	I _C = 120A, V _{CC} = 400V, V _{GE} =15V R _G = 4.7Ω, L = 66μH, T _J = 25°C
E _{off}	Turn-Off Switching Loss	—	3430	—		
E _{total}	Total Switching Loss	—	7900	—		
t _{d(on)}	Turn-On delay time	—	80	—	ns	Energy losses include tail & diode reverse recovery ⑤
t _r	Rise time	—	75	—		
t _{d(off)}	Turn-Off delay time	—	190	—		
t _f	Fall time	—	40	—		
E _{on}	Turn-On Switching Loss	—	5360	—		
E _{off}	Turn-Off Switching Loss	—	4390	—	μJ	I _C = 120A, V _{CC} = 400V, V _{GE} =15V R _G = 4.7Ω, L = 66μH, T _J = 175°C
E _{total}	Total Switching Loss	—	9750	—		
t _{d(on)}	Turn-On delay time	—	80	—		
t _r	Rise time	—	130	—	ns	Energy losses include tail & diode reverse recovery ⑤
t _{d(off)}	Turn-Off delay time	—	260	—		
t _f	Fall time	—	90	—		
C _{ies}	Input Capacitance	—	7660	—	pF	V _{GE} = 0V V _{CC} = 30V f = 1.0MHz
C _{oes}	Output Capacitance	—	470	—		
C _{res}	Reverse Transfer Capacitance	—	250	—		
RBSOA	Reverse Bias Safe Operating Area	FULL SQUARE				T _J = 175°C, I _C = 480A V _{CC} = 480V, V _p ≤ 600V V _{GE} = +20V to 0V
SCSOA	Short Circuit Safe Operating Area	5	—	—	μs	T _J = 150°C, V _{CC} = 400V, V _p ≤ 600V V _{GE} = +15V to 0V
E _{rec}	Reverse Recovery Energy of the Diode	—	420	—	μJ	T _J = 175°C
t _{rr}	Diode Reverse Recovery Time	—	95	—	ns	V _{CC} = 400V, I _F = 24A, V _{GE} = 15V
I _{rr}	Peak Reverse Recovery Current	—	34	—	A	R _g = 4.7Ω, L=200μH, L _s =150nH

Notes:

- ① V_{CC} = 80% (V_{CES}), V_{GE} = 20V, R_G = 4.7Ω, L=66μH.
- ② R_θ is measured at T_J of approximately 90°C.
- ③ Refer to AN-1086 for guidelines for measuring V_{(BR)CES} safely.
- ④ Pulse width limited by max. junction temperature.
- ⑤ Values influenced by parasitic L and C in measurement.
- ⑥ f_{sw} = 40KHz, refer to figure 26.

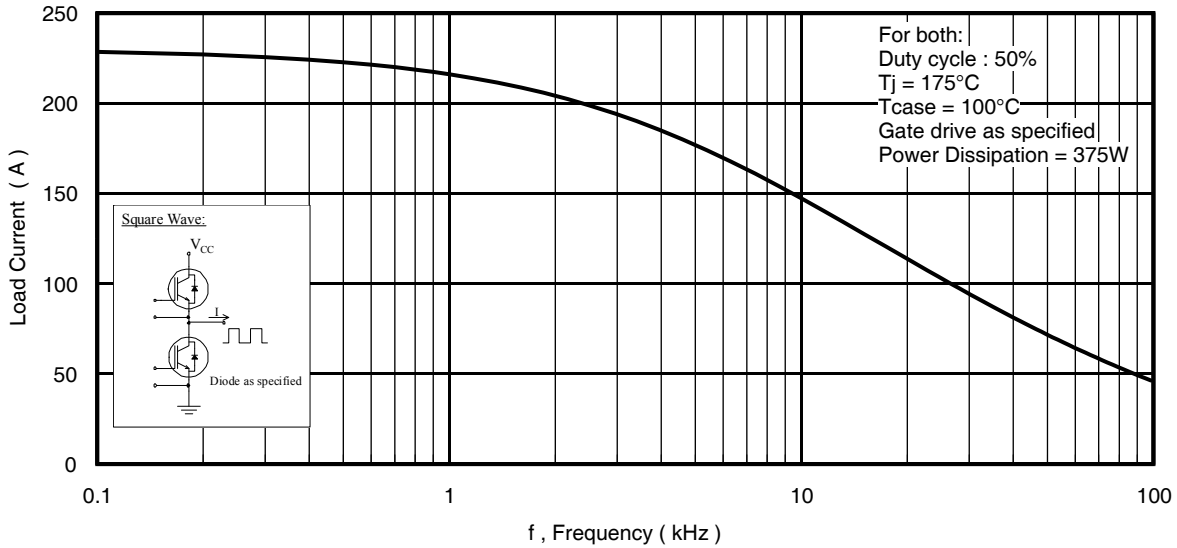

Fig. 1 - Typical Load Current vs. Frequency
(Load Current = I_{RMS} of fundamental)

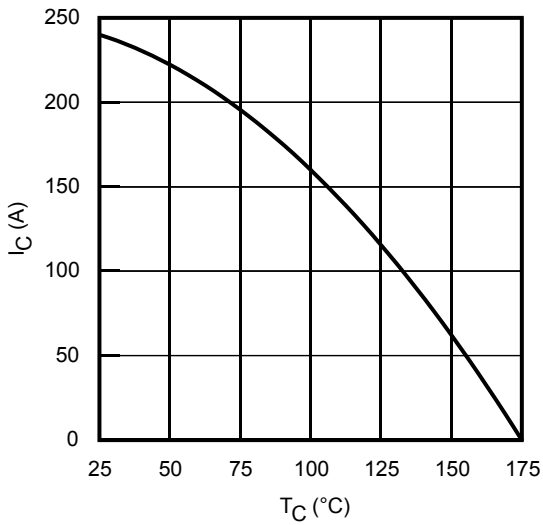

Fig. 2 - Maximum DC Collector Current vs. Case Temperature

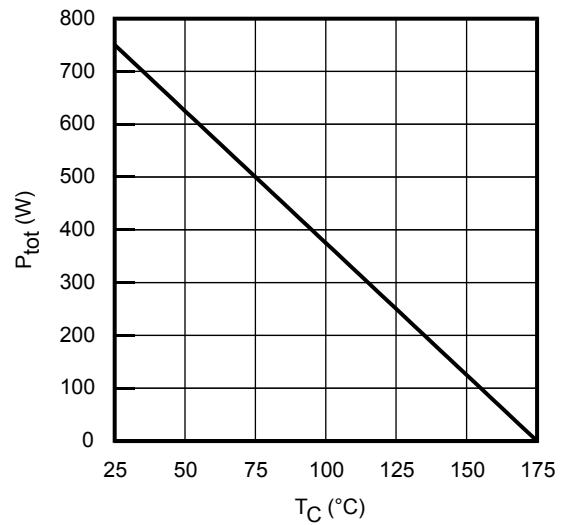

Fig. 3 - Power Dissipation vs. Case Temperature

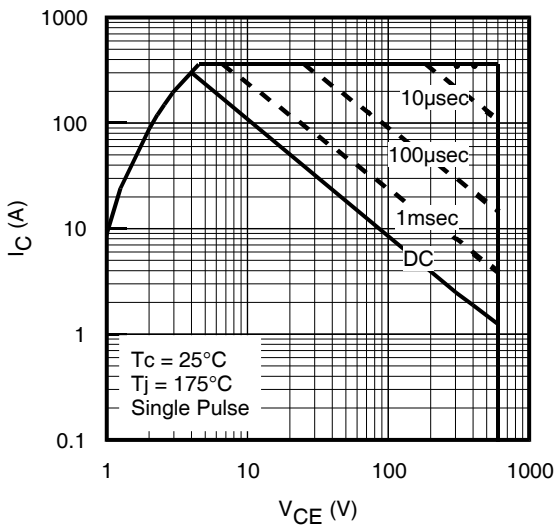

Fig. 4 - Forward SOA
 $T_C = 25^\circ\text{C}; T_J \leq 175^\circ\text{C}; V_{GE} = 15\text{V}$

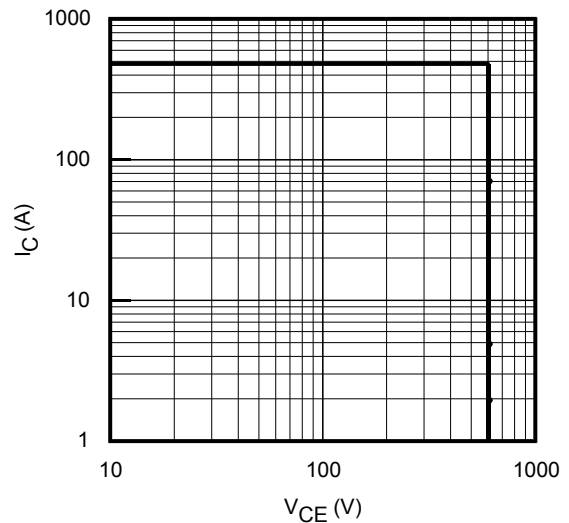

Fig. 5 - Reverse Bias SOA
 $T_J = 175^\circ\text{C}; V_{GE} = 20\text{V}$

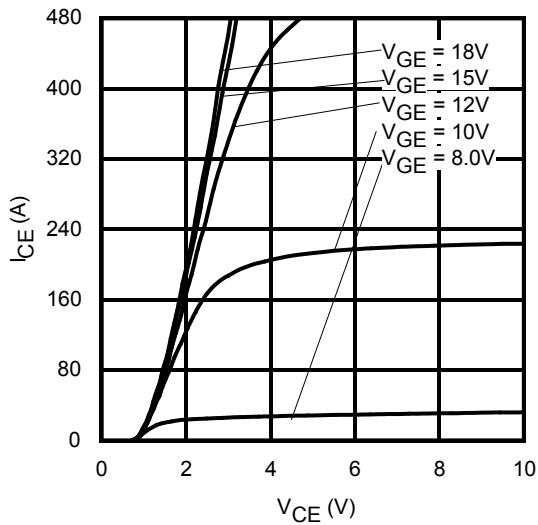

Fig. 6 - Typ. IGBT Output Characteristics
 $T_J = -40^\circ\text{C}; t_p = 20\mu\text{s}$

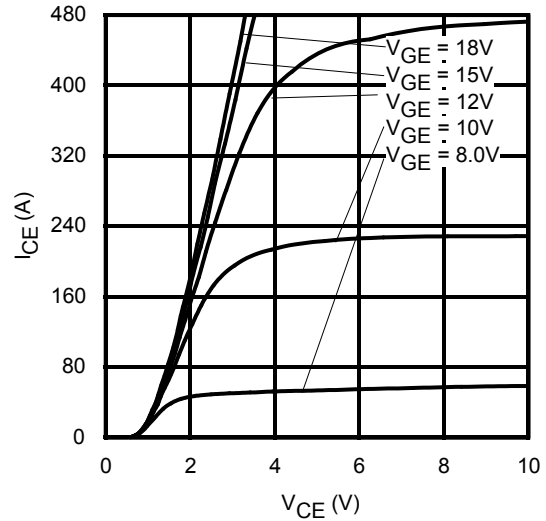

Fig. 7 - Typ. IGBT Output Characteristics
 $T_J = 25^\circ\text{C}; t_p = 20\mu\text{s}$

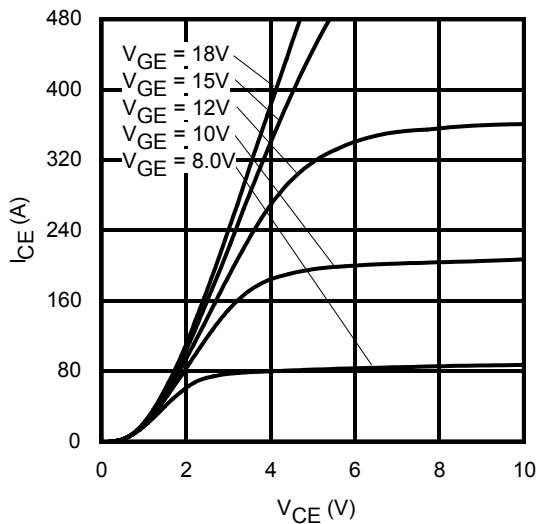

Fig. 8 - Typ. IGBT Output Characteristics
 $T_J = 175^\circ\text{C}; t_p = 20\mu\text{s}$

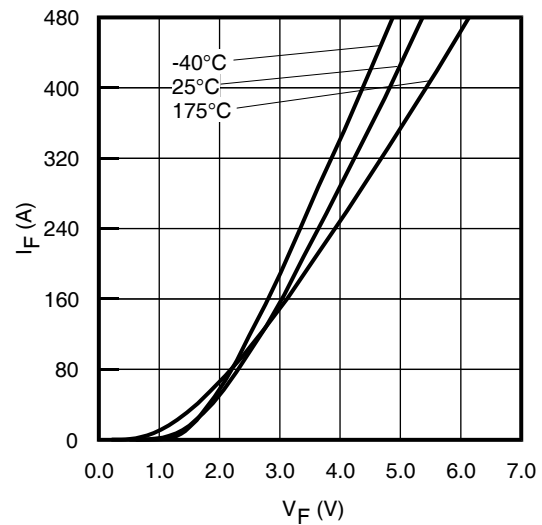

Fig. 9 - Typ. Diode Forward Voltage Drop Characteristics

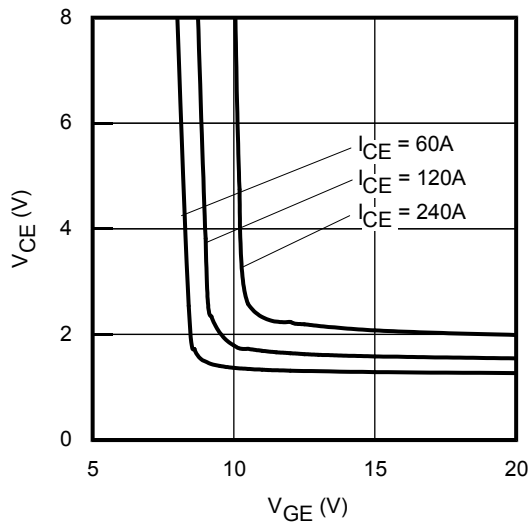

Fig. 10 - Typical V_{CE} vs. V_{GE}
 $T_J = -40^\circ\text{C}$

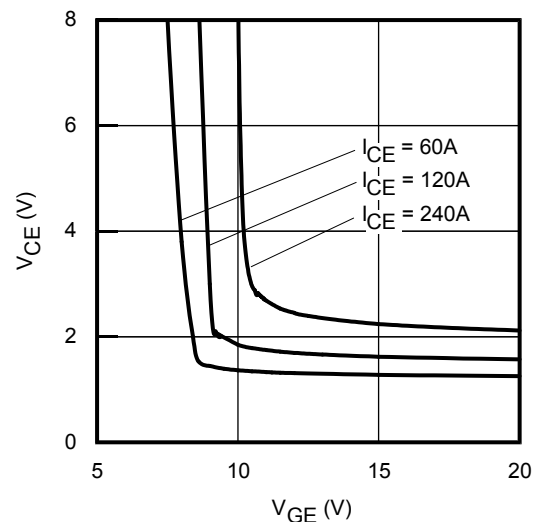

Fig. 11 - Typical V_{CE} vs. V_{GE}
 $T_J = 25^\circ\text{C}$

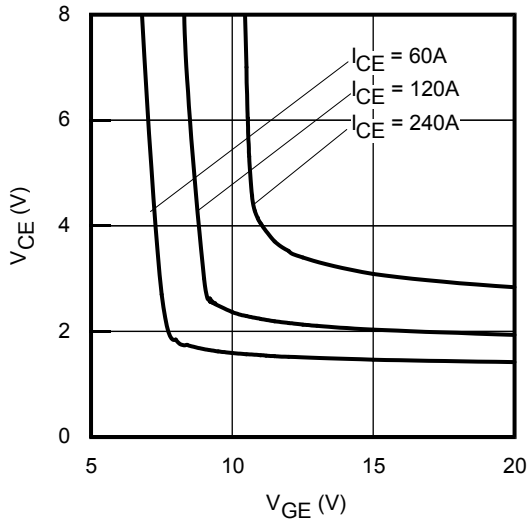

Fig. 12 - Typical V_{CE} vs. V_{GE}
 $T_J = 175^\circ\text{C}$

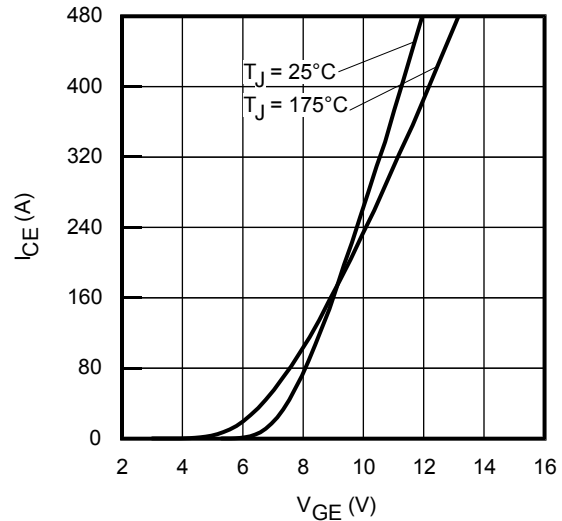

Fig. 13 - Typ. Transfer Characteristics
 $V_{CE} = 50\text{V}$; $t_p = 20\mu\text{s}$

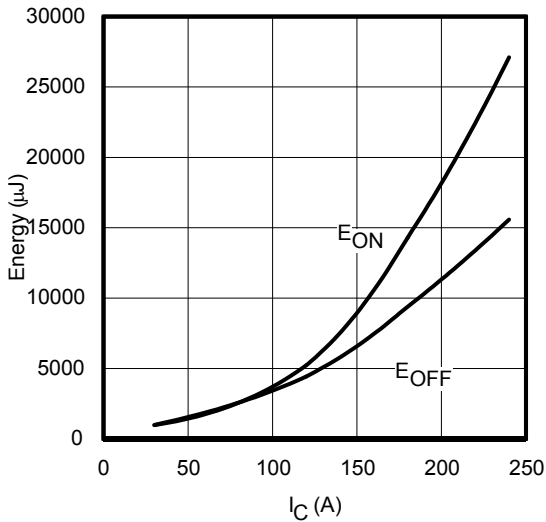

Fig. 14 - Typ. Energy Loss vs. I_C
 $T_J = 175^\circ\text{C}$; $V_{CE} = 400\text{V}$, $R_G = 4.7\ \Omega$; $V_{GE} = 15\text{V}$

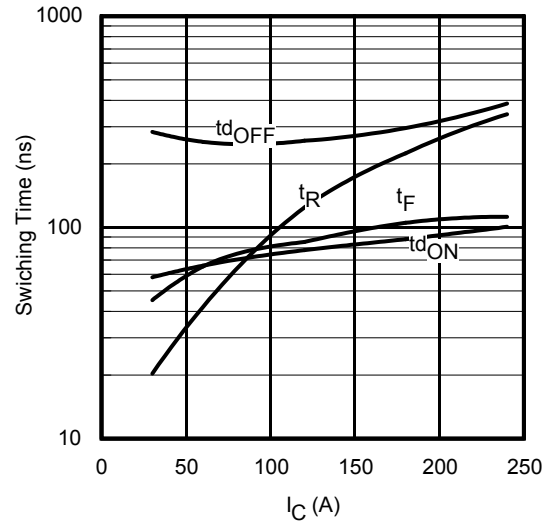

Fig. 15 - Typ. Switching Time vs. I_C
 $T_J = 175^\circ\text{C}$; $V_{CE} = 400\text{V}$, $R_G = 4.7\ \Omega$; $V_{GE} = 15\text{V}$

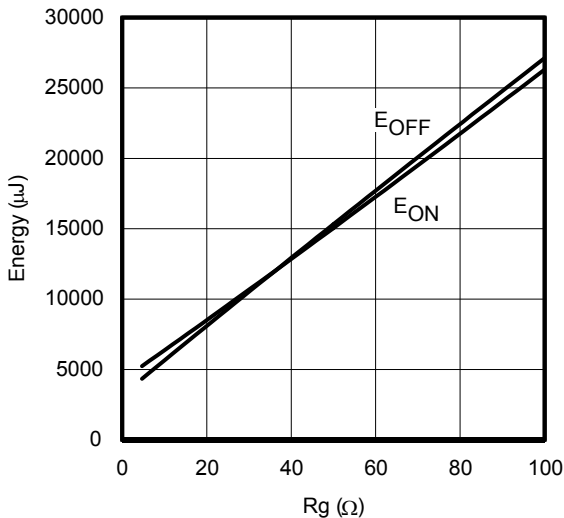

Fig. 16 - Typ. Energy Loss vs. R_G
 $T_J = 175^\circ\text{C}$; $V_{CE} = 400\text{V}$, $I_{CE} = 120\text{A}$; $V_{GE} = 15\text{V}$

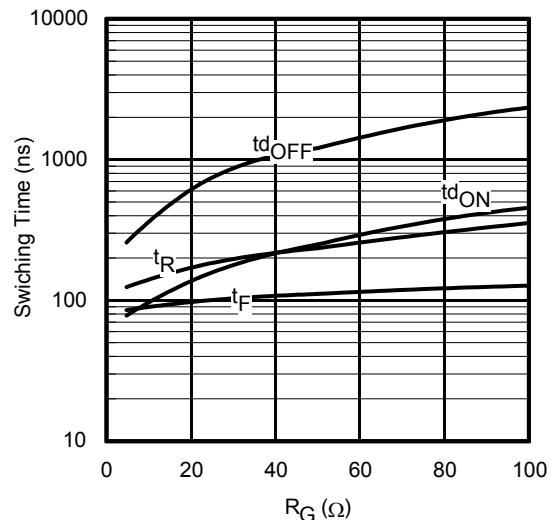

Fig. 17 - Typ. Switching Time vs. R_G
 $T_J = 175^\circ\text{C}$; $V_{CE} = 400\text{V}$, $I_{CE} = 120\text{A}$; $V_{GE} = 15\text{V}$

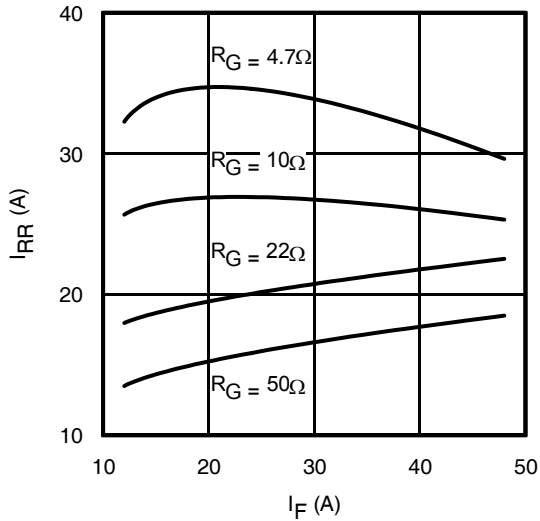

Fig. 18 - Typ. Diode I_{RR} vs. I_F
 $T_J = 175^\circ\text{C}$

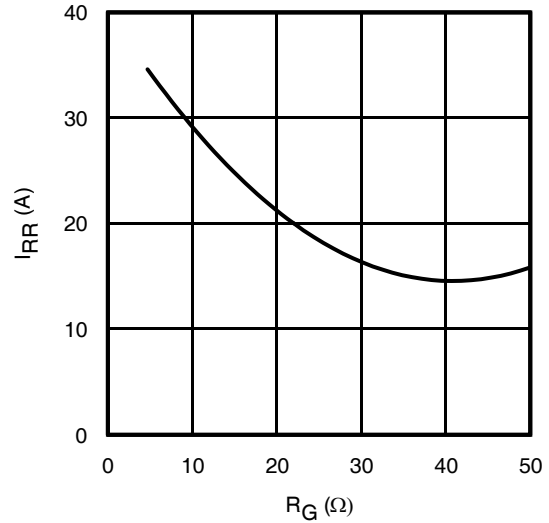

Fig. 19 - Typ. Diode I_{RR} vs. R_G
 $T_J = 175^\circ\text{C}$

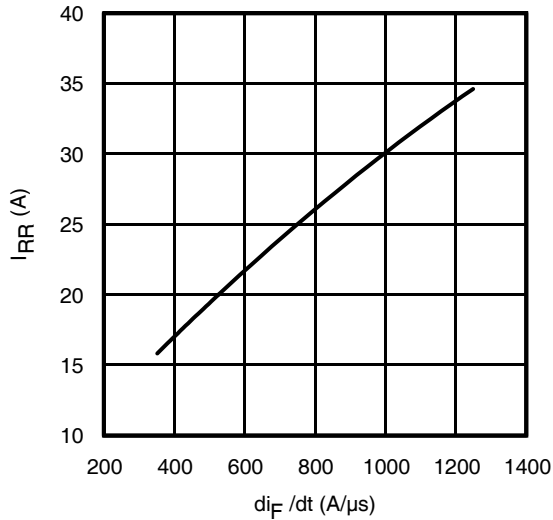

Fig. 20 - Typ. Diode I_{RR} vs. di_F/dt
 $V_{CC} = 400\text{V}; V_{GE} = 15\text{V}; I_F = 24\text{A}; T_J = 175^\circ\text{C}$

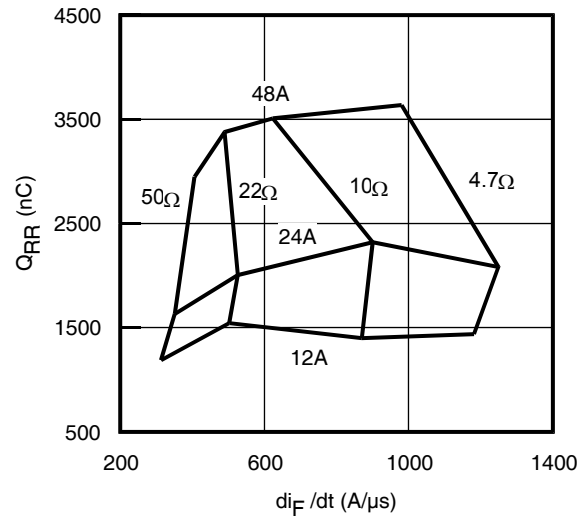

Fig. 21 - Typ. Diode Q_{RR} vs. di_F/dt
 $V_{CC} = 400\text{V}; V_{GE} = 15\text{V}; T_J = 175^\circ\text{C}$

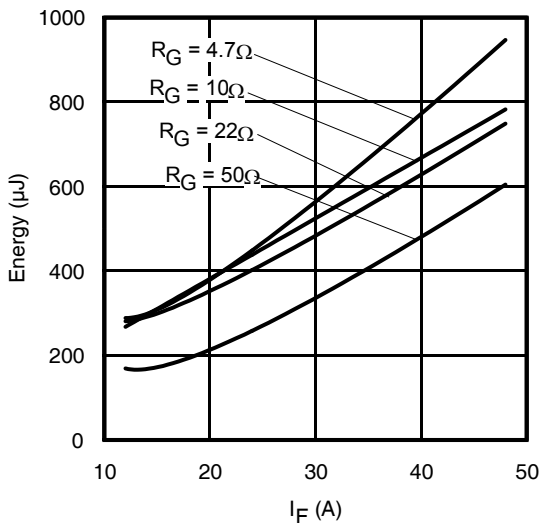

Fig. 22 - Typ. Diode E_{RR} vs. I_F
 $T_J = 175^\circ\text{C}$

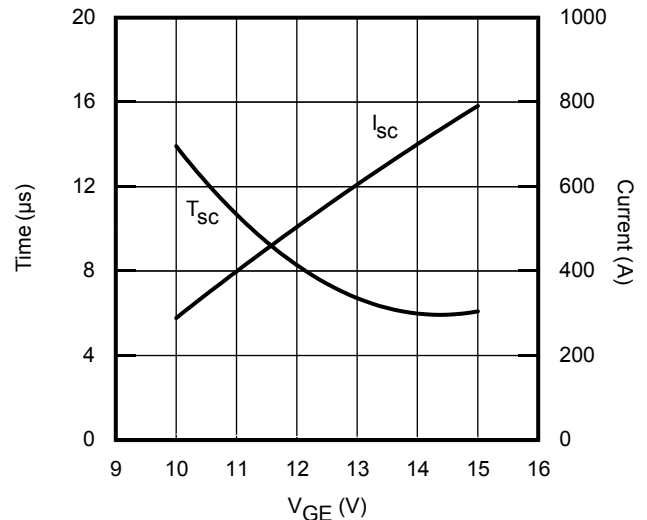

Fig. 23 - V_{GE} vs. Short Circuit Time
 $V_{CC} = 400\text{V}; T_C = 150^\circ\text{C}$

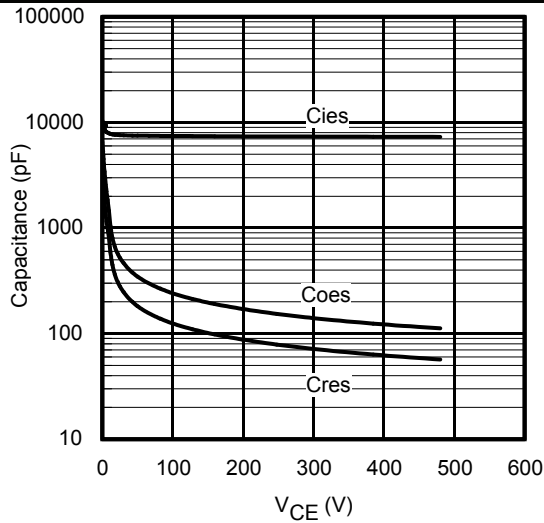

Fig. 24 - Typ. Capacitance vs. V_{CE}
 $V_{GE} = 0V$; $f = 1MHz$

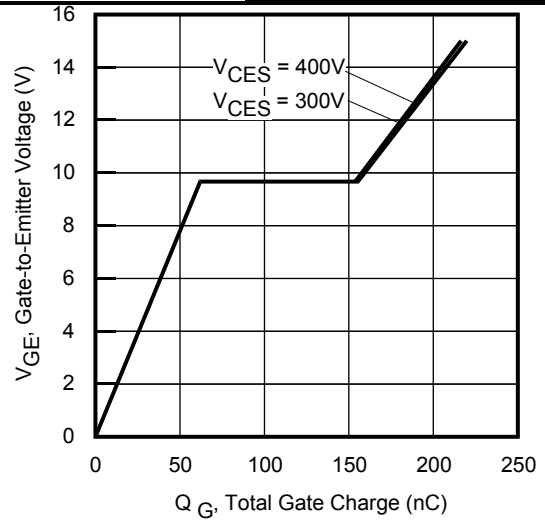

Fig. 25 - Typical Gate Charge vs. V_{GE}
 $I_{CE} = 120A$

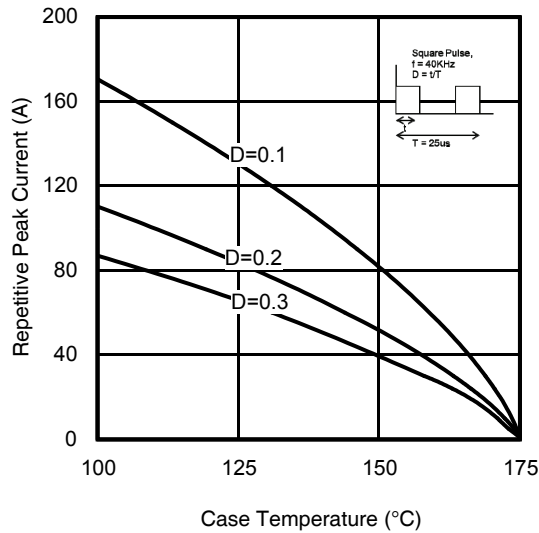

Fig 26. Maximum Diode Repetitive Forward Peak Current vs. Case Temperature

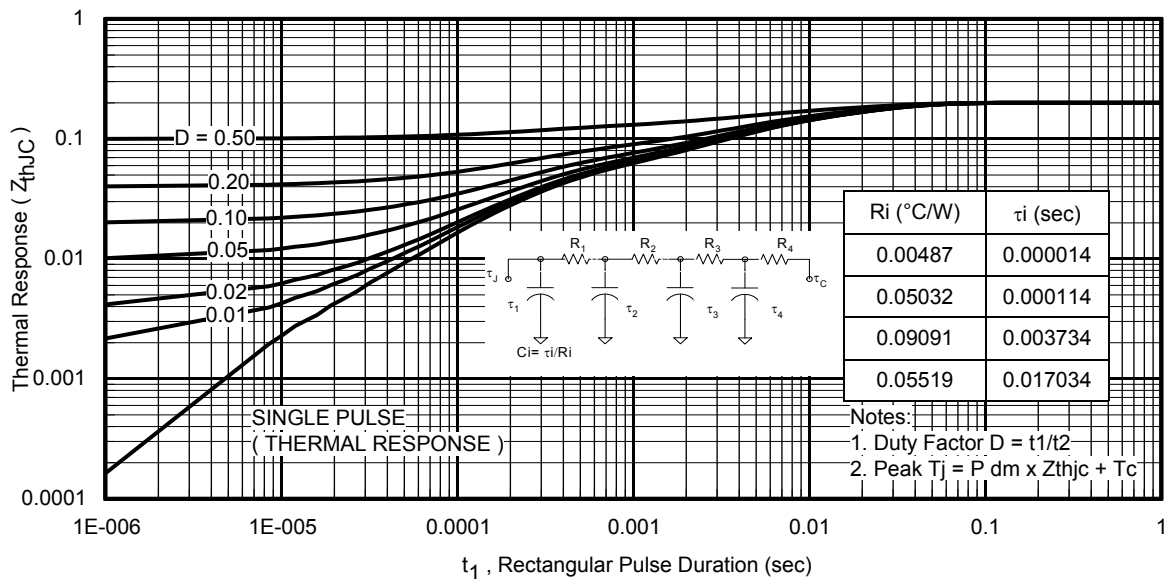

Fig. 27 - Maximum Transient Thermal Impedance, Junction-to-Case (IGBT)

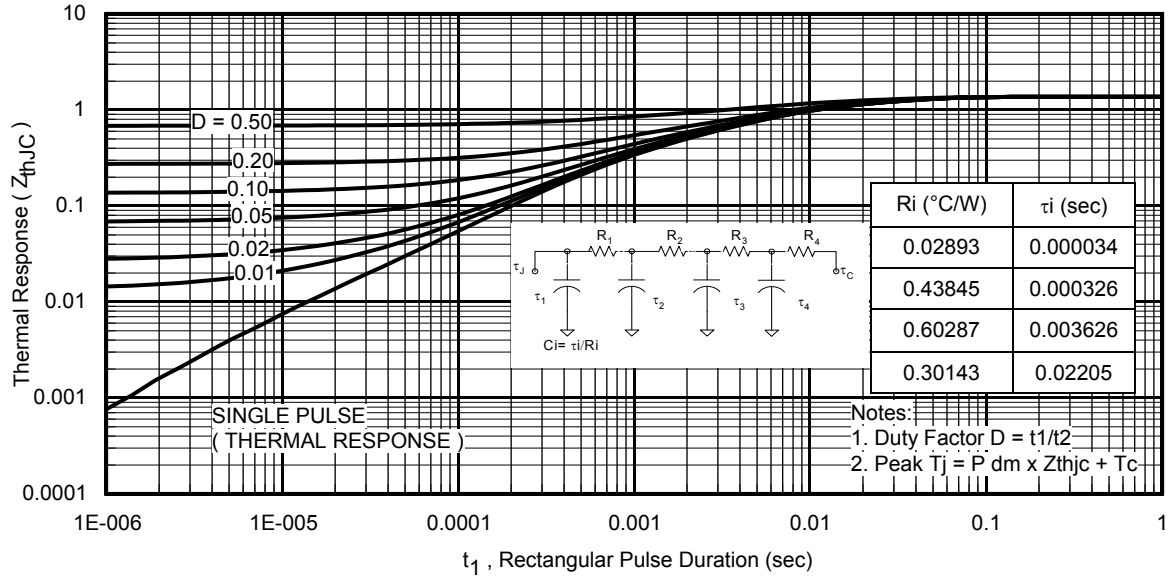

Fig. 28 - Maximum Transient Thermal Impedance, Junction-to-Case (DIODE)

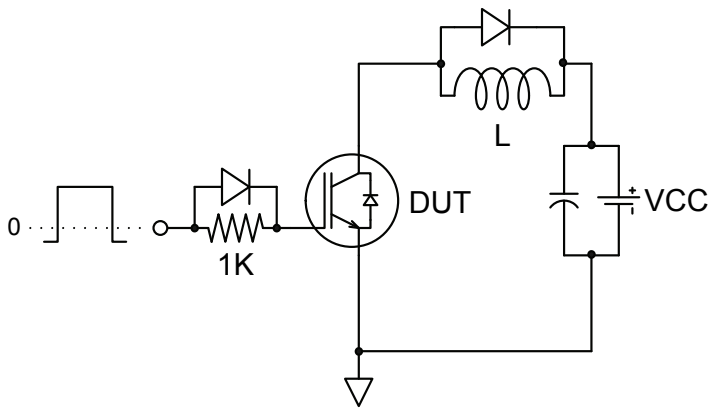

Fig.C.T.1 - Gate Charge Circuit (turn-off)

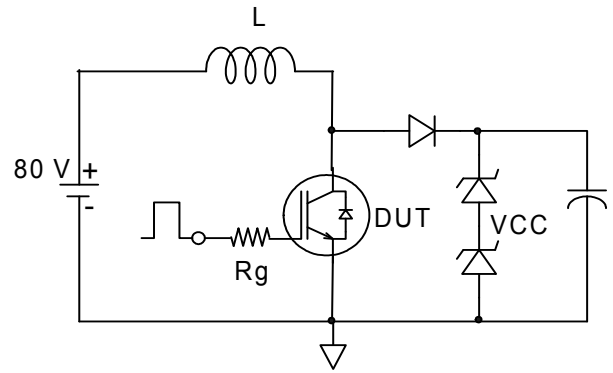

Fig.C.T.2 - RBSOA Circuit

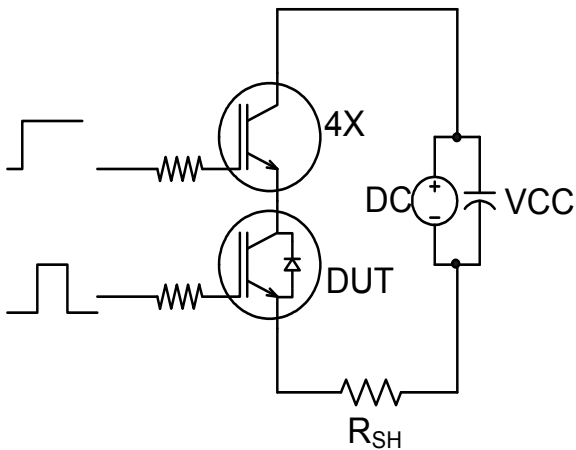

Fig.C.T.3 - S.C. SOA Circuit

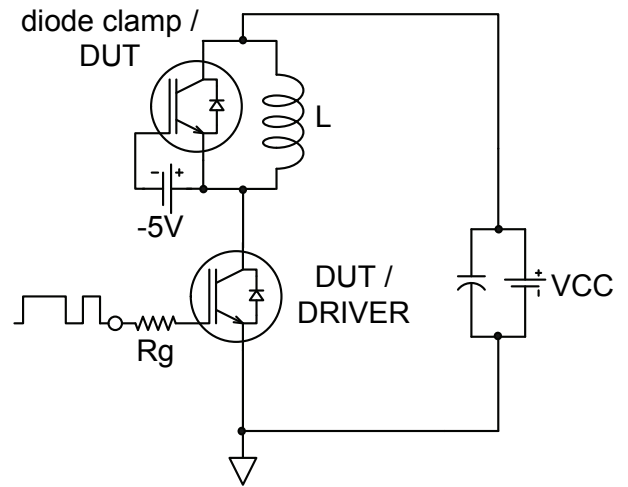

Fig.C.T.4 - Switching Loss Circuit



Fig.C.T.5 - Resistive Load Circuit



Fig.C.T.6 - BVCES Filter Circuit

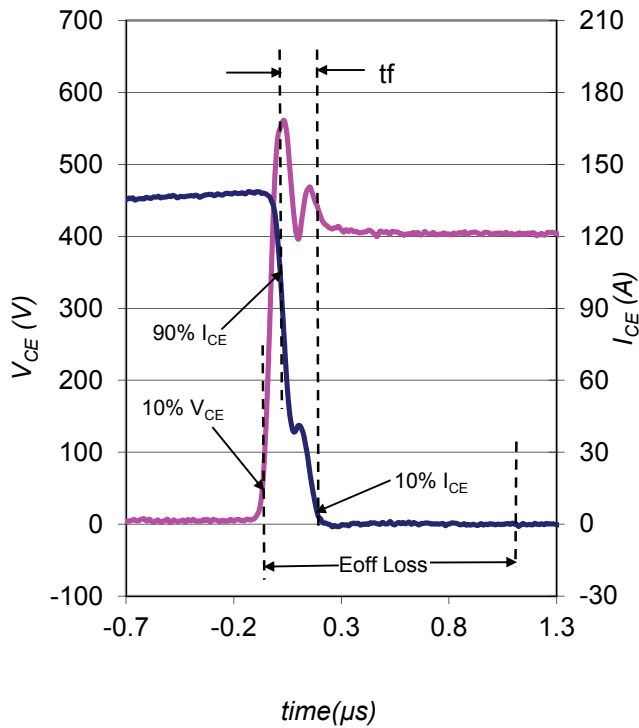

Fig. WF1 - Typ. Turn-off Loss Waveform
@ $T_J = 175^\circ\text{C}$ using Fig. CT.4

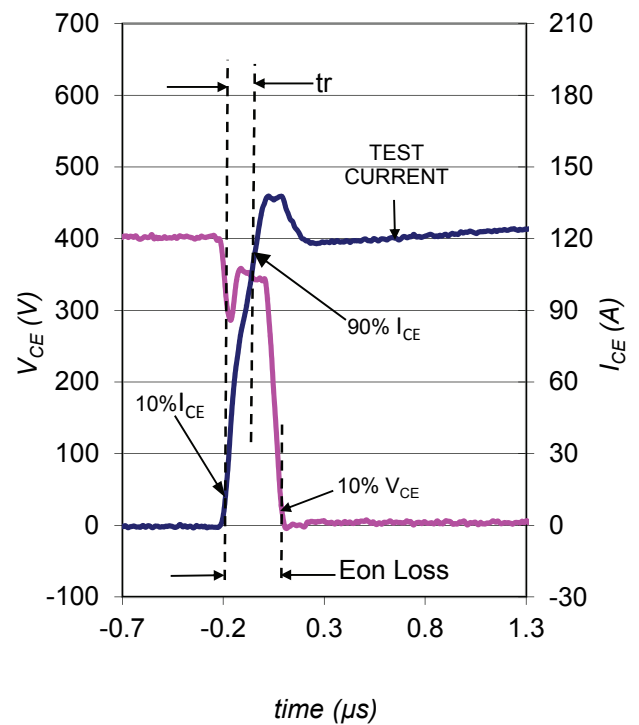

Fig. WF2 - Typ. Turn-on Loss Waveform
@ $T_J = 175^\circ\text{C}$ using Fig. CT.4

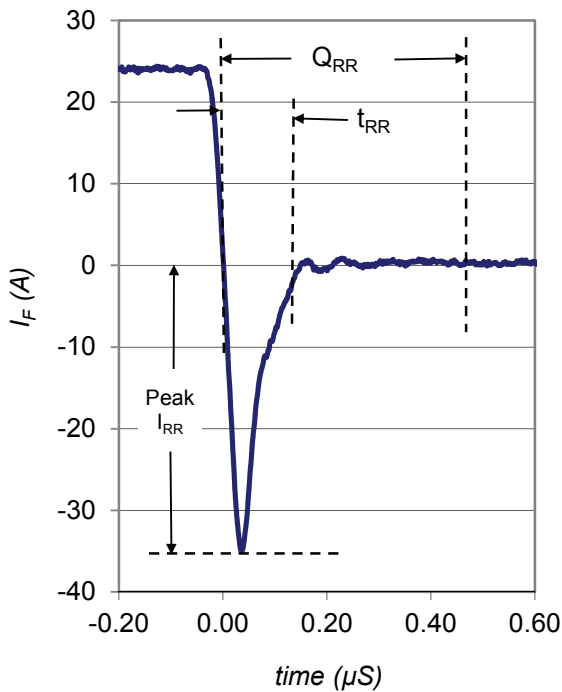

Fig. WF3 - Typ. Diode Recovery Waveform
@ $T_J = 175^\circ\text{C}$ using Fig. CT.4

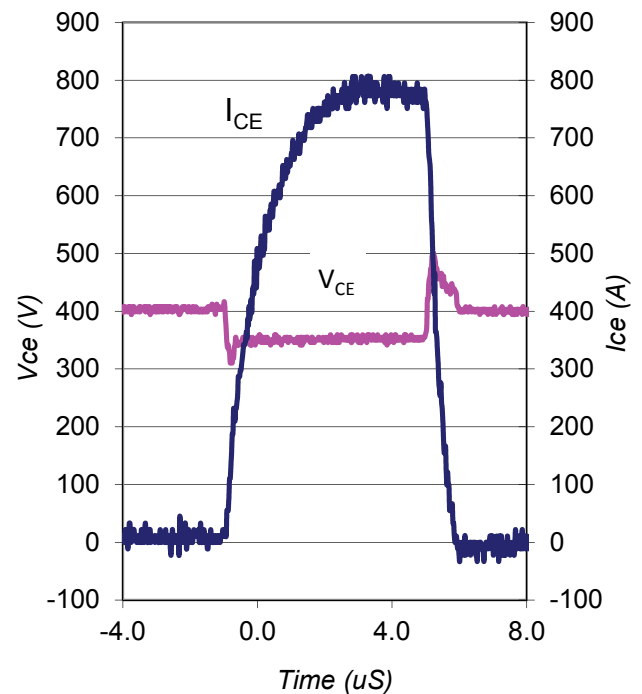
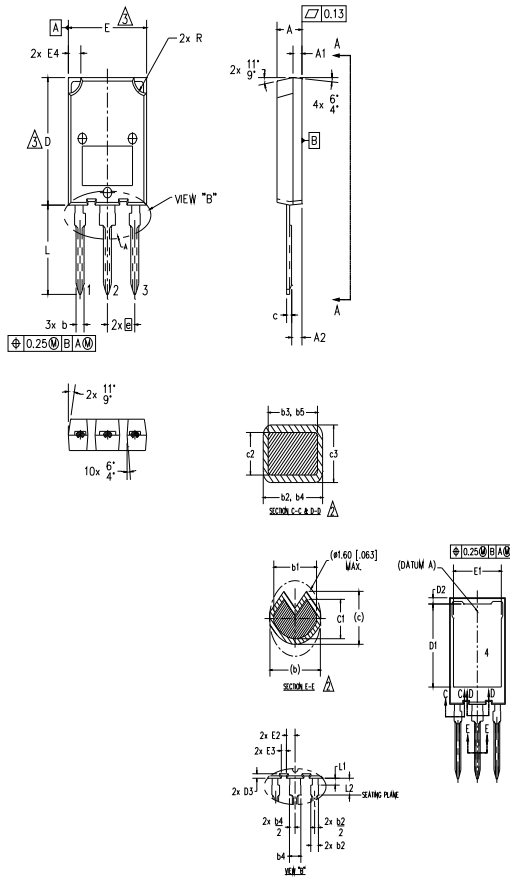

Fig. WF4 - Typ. S.C. Waveform
@ $T_J = 150^\circ\text{C}$ using Fig. CT.3

Super 247 Package Outline

Dimensions are shown in millimeters (inches)



NOTES:

1. DIMENSIONING AND TOLERANCING AS PER ASME Y14.5M-1994
2. DIMENSIONS b1, b3, b5, c1 & c3 APPLY TO BASE METAL ONLY.
3. DIMENSION D & E DO NOT INCLUDE MOLD FLASH. MOLD FLASH SHALL NOT EXCEED 0.127 [0.005"] PER SIDE. THESE DIMENSIONS ARE MEASURED AT THE OUTER EXTREMES OF THE PLASTIC BODY.
4. ALL DIMENSIONS SHOWN IN MILLIMETERS.
5. CONTROLLING DIMENSION: MILLIMETER.
6. OUTLINE CONFORMS TO JEDEC OUTLINE TO-274AA

SYMBOL	DIMENSIONS				NOTES
	MILLIMETERS		INCHES		
	MIN.	MAX.	MIN.	MAX.	
A	4.50	5.50	.177	.217	
A1	1.45	2.15	.057	.085	
A2	1.65	2.35	.065	.093	
b	1.45	1.60	.054	.063	
b1	1.40	1.50	.055	.059	2
b2	2.00	2.40	.079	.094	
b3	1.95	2.35	.077	.093	2
b4	3.00	3.15	.118	.124	
b5	2.95	3.35	.116	.132	2
c	1.10	1.30	.043	.051	
c1	0.90	1.10	.035	.043	2
c2	0.65	0.85	.026	.033	
c3	0.50	0.70	.020	.028	2
D	19.80	20.80	.780	.819	3
D1	15.50	16.10	.610	.634	
D2	0.70	1.30	.028	.051	
D3	0.75	1.25	.030	.049	
E	15.10	16.10	.594	.634	3
E1	13.30	13.90	.524	.547	
E2	2.25	2.70	.089	.109	
E3	1.20	1.70	.047	.067	
E4	2.00	3.00	.079	.118	
e	5.45 BSC		.215 BSC		
L	13.80	14.80	.535	.583	
L1	1.00	1.60	.039	.063	
L2	3.85	4.25	.152	.167	
R	2.00	3.00	.079	.118	

LEAD ASSIGNMENTS

MOSFET

- 1.- GATE
- 2.- DRAIN
- 3.- SOURCE
- 4.- DRAIN

IGBT

- 1.- GATE
- 2.- COLLECTOR
- 3.- EMITTER
- 4.- COLLECTOR

Super 247 Part Marking Information

EXAMPLE: THIS IS AN IRFPS37N50A WITH ASSEMBLY LOT CODE 1789 ASSEMBLED ON WW 19, 1997 IN THE ASSEMBLY LINE "C"

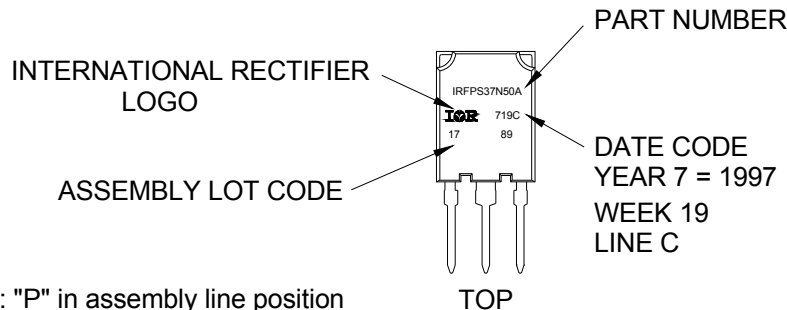

Note: "P" in assembly line position indicates "Lead-Free"

Super 247 package is not recommended for Surface Mount Application.

Note: For the most current drawing please refer to IR website at <http://www.irf.com/package/>

Qualification Information[†]

Qualification Level	Industrial	
Moisture Sensitivity Level	Super 247	N/A
RoHS Compliant	Yes	

† Qualification standards can be found at International Rectifier’s web site: <http://www.irf.com/product-info/reliability/>

†† Applicable version of JEDEC standard at the time of product release.

Revision History

Date	Comments
11/13/2014	<ul style="list-style-type: none"> • Added I_{FM} Diode Maximum Forward Current = 480A with the note ④ on page 1. • Removed note ④ from switching losses test condition on page 2.