

TDK Corporation
Corporate Headquarters
13-1,Nihonbashi 1-chome,Chuo-ku
Tokyo 103-8272 Japan
Phone : Tokyo(03)5201-7229

Branch Office
Sales div. Phone ()

PRODUCT SPECIFICATION

SPEC.No. C479NAA00005_1
DATE 2009/3/24

Digi-Key Corporation

CUSTOMER'S PRODUCT NAME :
TDK PRODUCT NAME : <p style="text-align: center;">FL3215T-000X</p>
THIS SPECIFICATION IS : <input type="checkbox"/> FULLY RECEIVED <input type="checkbox"/> DENIED <input type="checkbox"/> RECEIVED UNDER THE FOLLOWING CONDITION
SIGNATURE : _____ DATE: _____ NAME(PRINT) : _____ TITLE : _____

Circuit Devices Business Group			Sales Division	
PREPARED BY	APPROVED BY	AUTHORIZED BY	REVIEWED BY	AUTHORIZED BY
S.Kikuchi Mar.24.'09	M.Takeda Mar.24.'09	H.Itoh Mar.24.'09		

CAUTION FOR SAFETY USING

When use the products, be careful to mentioned below for safety using.
If make mistake in using ,be afraid of OPEN,SHORT,SMOKE.

CAUTION WHEN HANDLING

Before use the products, must be read this specification.

The products listed on this specification sheet are intended for use in general electronic equipment (AV equipment, telecommunications equipment, home appliances, amusement equipment, computer equipment, personal equipment, office equipment, measurement equipment, industrial robots) under a normal operation and use condition.

The products are not designed or warranted to meet the requirements of the applications listed below, whose performance and/or quality require a more stringent level of safety or reliability, or whose failure, malfunction or trouble could cause serious damage to society, person or property. we are not responsible for any damage or liability caused by use of the products in any of the applications below or for any other use exceeding the range or conditions set forth in this specification sheet.

- | | |
|--|---|
| ① Aerospace/Aviation equipment | ⑧ Public information-processing equipment |
| ② Transportation equipment(cars, electric trains, ships,etc) | ⑨ Military equipment |
| ③ Medical equipment | ⑩ Electric heating apparatus, burning equipment |
| ④ Power-generation control equipment | ⑪ Disaster prevention/crime prevention equipment |
| ⑤ Atomic energy-related equipment | ⑫ Safety equipment |
| ⑥ Seabed equipment | ⑬ Other applications that are not considered general-purpose applications |
| ⑦ Transportation control equipment | |

When using this product in general-purpose applications, you are kindly requested to take into consideration securing protection circuit/equipment or providing backup circuits, etc., to ensure higher safety.

- The product should be used within 6 months of receipt, Storage area must remain cool and dry, and free of corrosive fumes to ensure solder ability.
- Add excessive bending stress to P.C.Board, the products may open defect. So be careful to set up of mounter.
- Comply with the specifications for rework on soldering after being mounted; excessive heating may result in short circuits, degradation, compromised reliability,etc.
- As the product temperature rises due to self-heating, the margin(of temperature rise) must be taken into account.
- As the magnetic field rises around the product due to current, take precautions in wrong action.
- Take precautions in placement orientation of unshielded type inductors, for malfunction may occur due to magnetic interference, coupling.
- Consult TDK for operating conditions of interlayer withstand voltage.
- Do not use the product in a corrosive environment (gas, salt, acid, alkaline, etc).
- The product is not designed for radiation proof applications.

Handling Precautions

TDK CORPORATION

1. Scope

These specifications apply to the SMD inductors FL3215 which Digi-Key Corporation has requested delivery.

2. Product Name

The products, which fall under these specifications, are given the name of Customer
TDK FL3215T-000X

3. Product Name description

FL 32 15 I - 000 X
 1 2 3 4 5 6

- 1. Product type
- 2. Product length
- 3. Product height
- 4. Package type T(Taping)
- 5. Inductance value (name)
- 6. Inductance tolerance
 K(+/-10%) M(+/-20%)

4. Table of contents

Contents	Page
1. Exterior, Construction & dimensions. And the recommended land pattern, Internal structure	2
2. Electrical characteristics and measuring jig	3,4
3. Ratings	5
4. Others	5
5. Tests	6
6. Packaging specification	7,8
7. The recommended Soldering condition	9

5. Country of origin

Country of origin Japan

Factory TDK Shonai corporation Tsuruoka, Yamagata, Japan

Revision

revision	Date	Person	Revision contents
division		Issue date	
TDK Corporation		2009/3/24	
Magnetics Business Group		DRAWING No. C479NAA00005_1	
		PAGE 1 /9	

1. Exterior, Construction and dimensions

1.1. Outline dimensions

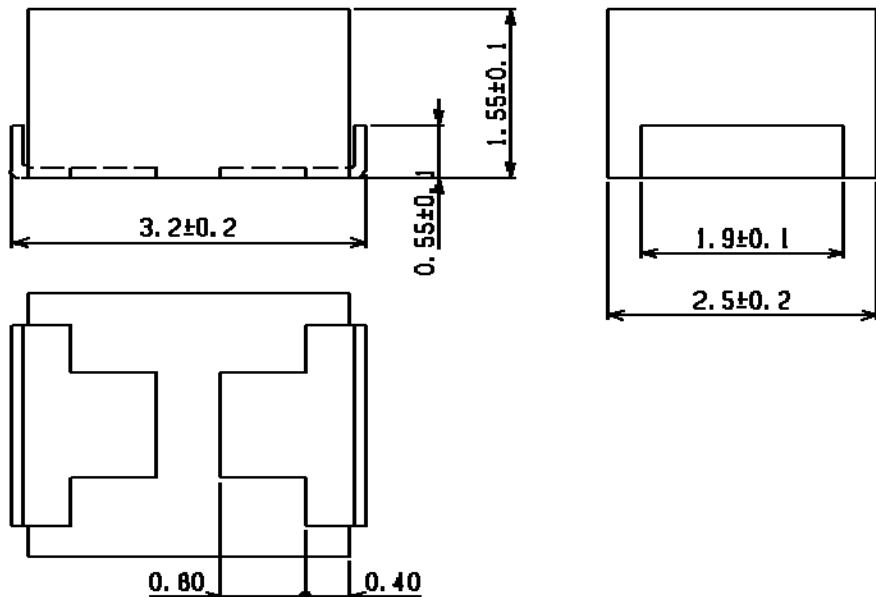
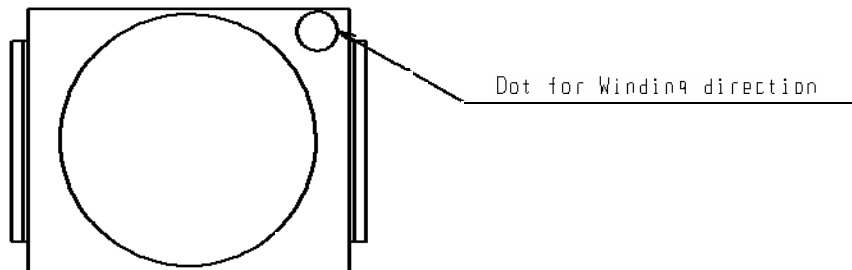

1.2. The recommended land pattern

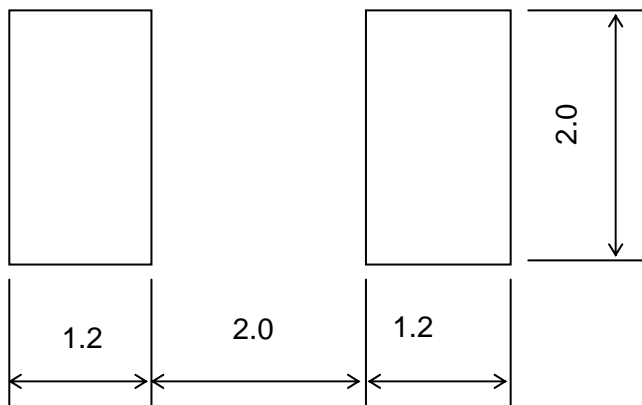

1.3. Internal structure

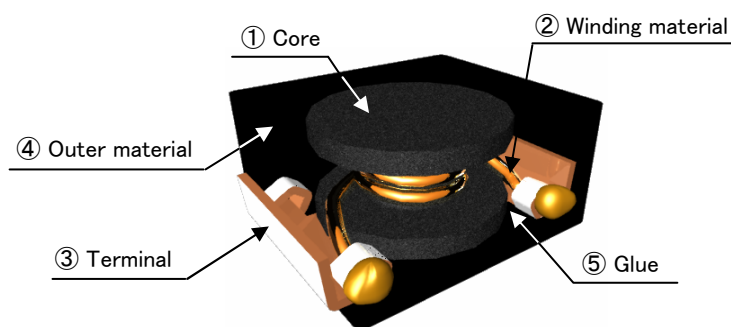

1	Core	1	Ferrite	
2	Winding material	1	Cu	
3	Terminal	2	Cu alloy	Sn plated
4	Outer material	-	Thermoplastic resin	
5	Glue	-	epoxy	
No	PARTS	Q.ty	MATERIALS	REMARK

SCALE	UNIT
-	mm
SIZE	THIRD ANGLE PROJECTION
-	

TDK CORPORATION	NAME OF DRAWING	DRAWING No.	PAGE
	PRODUCT SPECIFICATION	C479NAA00005_1	2 /9

2. Electrical Characteristics and the measuring jig

2.1. Electrical Characteristics

Customer's P#	TDK item name	L [uH]	L tolerance [%]	Test freq. [MHz]	SRF [MHz] typ.	Rdc [ohm] +/-20%	Idc1 [mA] max.	Idc2 [mA] max.
	FL3215T-							
	R33M	0.33	±20%	1.0	280	0.030	1500	2300
	1R0M	1.0	±20%	1.0	100	0.045	1200	2050
	1R5M	1.5	±20%	1.0	90	0.07	1100	1600
	2R2M	2.2	±20%	1.0	70	0.08	1000	1400
	3R3M	3.3	±20%	1.0	60	0.12	800	1100
	4R7M	4.7	±20%	1.0	50	0.15	760	1000
	6R8M	6.8	±20%	1.0	40	0.20	640	700
	100K	10	±10%	1.0	30	0.30	520	650
	150K	15	±10%	1.0	25	0.50	400	500
	220K	22	±10%	1.0	19	0.70	340	440
	330K	33	±10%	1.0	17	1.10	270	340
	470K	47	±10%	1.0	14	1.40	210	300
	680K	68	±10%	1.0	11	2.30	180	240
	101K	100	±10%	1.0	10	3.50	140	200

*Idc1 : Value obtained when DC current flows and the initial value of inductance has fallen by 10%

*Idc2 : Self temperature rise 40degC. Max.

2.2 Electrical characteristics measurement equipment's

Inductance : Agilent 4294A PRECISION IMPEDANCE ANALYZER
 Rdc : ADEX AX-114N DIGITAL OHM METER
 SRF : Agilent E5071B Network Analyzer

2.3. Measuring jig

2.3.1. TDK TF-1

unit:mm

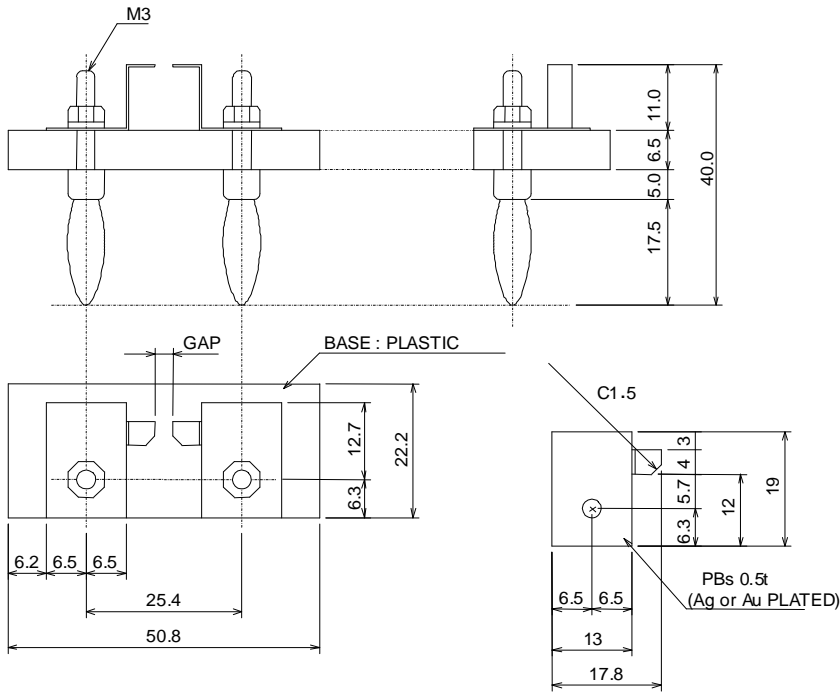

Gap	Dimension
Gap	3.0 mm

2.4.Examination conditions

Standard conditions is the temperature of 5 to 35 deg C, and 35 to 85% of humidity.
 When a doubt arises, it considers as the temperature of 20 +/- 2 deg C,
 and 65 +/- 5% of humidity.

3. Ratings

Self Temperature arising : less than 40 deg C
Storage temperature range : -40 deg C to +125 deg C
Operating temperature range : -40 deg C to +125 deg C (include self temperature rise)
Rating current : When the rating current flows, inductance should not drop more than 10 %.

4. Others

- * Should any doubts arise about this specification and others, it should be cleared by a conference between the customer and TDK.
- * Product storage limit
The storage limit of the products is 6 months with a temperature (20+/-10 deg.C) and a humidity (60+/-20%RH) whichever opened or not opened. The start of that should be the delivered date.
About the product which has been left more than 6 months, please check the solderability and the peeling strength of the tape. Then please judge whether it is OK or not.
- * Please do not use the dropped product.

TDK CORPORATION	NAME OF DRAWING	DRAWING No.	PAGE
	PRODUCT SPECIFICATION	C479NAA00005_1	5 /9

5. Tests

5.1. Reliability tests

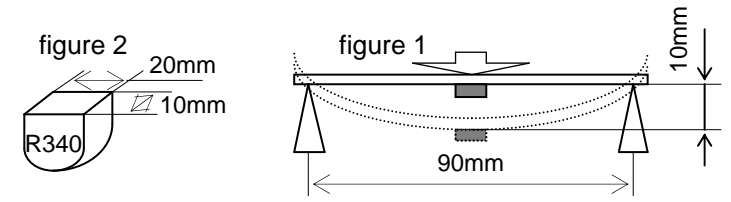
Test name	Test method	Criteria
1 Flexibility	<p>The sample shall be soldered onto the PCB as shown in figure 1 and a load applied until the flexure in the arrow direction is made almost 10mm. Then it should be returned to its original position.</p> 	There should be no abnormality.
2 Drop	The sample shall be dropped once naturally onto a concrete floor from a height of 1.8 meter.	delta L/L0 <= +/- 5 % There should be no mechanical damage.
3 Vibration	The sample shall be soldered onto the PCB, then the vibration having the frequency of 10 to 500Hz/min. or the amplitude of 1.5mm should be applied.	delta L/L0 <= +/- 5 % There should be no mechanical damage.
4 solderability	Flux (rosin [JIS-K-5902] ,isopropyl alcohol [JIS-K-1522] and a solution [rosin 20+/-5wt%]) shall be coated over the whole of the sample beforehand, then it shall be preheated for about 2 minutes in 150 +0/-20 deg C. After that it shall be immersed for 3+1/-0 seconds fully in Pb-free solder [Sn-Ag3-Cu0.5] with 245+/-5 deg C.	More than 90% of the Terminal should be coated with new solder
5 Resistance to soldering heat	Flux (rosin [JIS-K-5902] ,isopropyl alcohol [JIS-K-1522] and a solution [rosin 20+/-5wt%]) shall be coated over the whole of the sample beforehand, then it shall be preheated for about 2 minutes in 150 +0/-20 deg C. After that it shall be immersed for 10+1/-0 seconds fully in Pb-free solder [Sn-Ag3-Cu0.5] with 260+/-5 deg C.	delta L/L0 <= +/- 5 % There should be no mechanical damage.
6 Temperature characteristics	The test shall be performed after the sample has stabilized in -40 to +125 deg C, and the value calculated based on 20 deg C.	delta L/L0 <= +/- 10 %

5.2. Environmental Tests

the measurement shall be made after the sample has been left in a normal temperature and normal humidity for 1 or 2 hours. Upon completion of those tests.

Test name	Test method	Criteria
1 Heat Shock	The sample should be soldered onto the PCB, then it shall be left into 1000 cycles of temperature cycling for -40 deg C/ +125 deg C, 30 minutes each as one cycle.	delta L/L0 <= +/- 10 % There should be no mechanical damage.
2 Low temperature storage	The sample shall be left for 1000 +/- 12 hours in an ambient temperature of -40+/-2 deg C.	delta L/L0 <= +/- 10 % delta Q/Q0 <= +/- 30 %
3 High temperature storage	The sample shall be left for 1000 +/- 12 hours in an ambient temperature of +125+/-2 deg C.	delta L/L0 <= +/- 10 % delta Q/Q0 <= +/- 30 %
4 Moisture storage	The sample shall be left for 1000 +/- 12 hours in an ambient temperature of +60+/-2 deg C and a humidity of 90 to 95%RH.	delta L/L0 <= +/- 10 % delta Q/Q0 <= +/- 30 %

6. Packaging specification

6.1. Dimensions of the emboss carrier tape

[unit:mm]

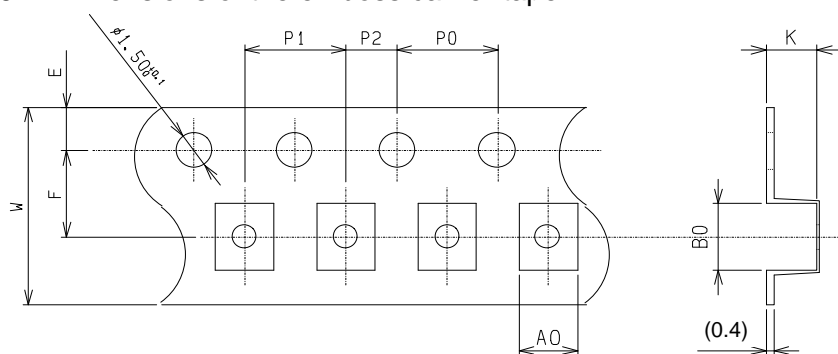

	A0	B0	K	W	F	E	P0	P1	P2
dimension	2.8	3.5	1.65	8.0+/-0.3	3.5+/-0.05	1.75+/-0.1	4.0+/-0.1	4.0+/-0.1	2.0+/-0.05

* It shows the reference value without the tolerance.

6.2. Dimensions of the reel.

[unit:mm]

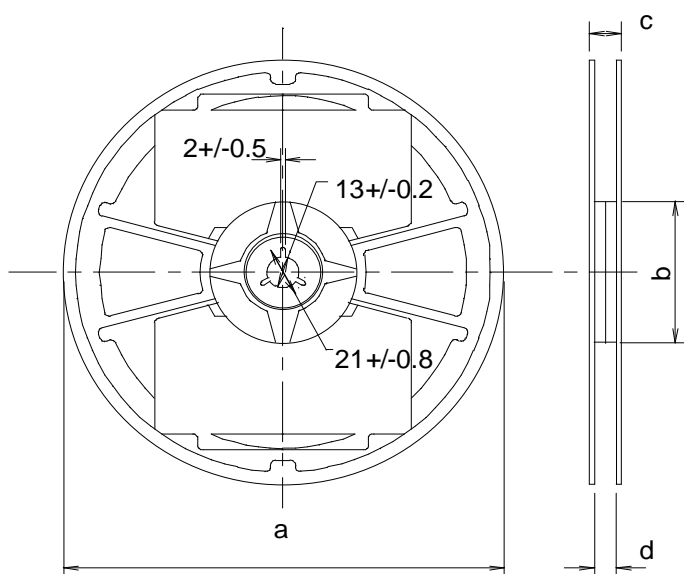

	Dimension	
a	ϕ 180 +0/-3	mm
b	ϕ 60 +1/-0	mm
c	13 +/- 1.4	mm
d	9.0 +/- 0.3	mm

6.3. Terminal part and Leader part tape

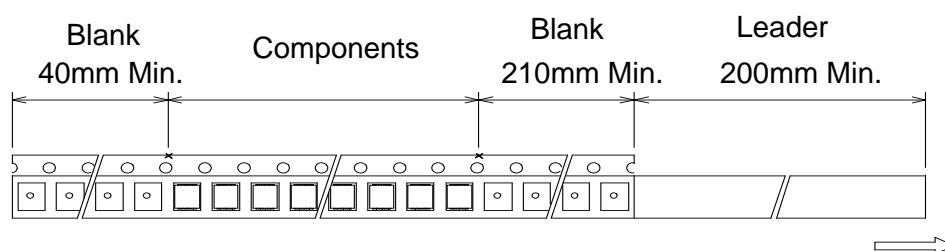

6.4. Taping tests

6.4.1. Peeling strength

Peeling strength : 0.098 to 0.686N (10 to 70gf)

Test conditions : The peel speed is 300 mm / minutes.

: The peel angle is 165 to 180 degree toward the adhesive surface.

6.4.2 The minimum bend radius

The minimum bend radius : 30mm

There should be no dropped or damaged one.

6.5. The quantity and form

2000 pieces / reel should be the standard.
 There should be no lack.
 There should be no joint in the carrier tape.

6.6. Lot. No.

T U 9 3 2 4 X X X X
 1 2 3 4 5

- 1 Factory code TU : TDK Shonai Corporation
- 2 Inspection year The bottom of A.D.
- 3 Inspection month October : X, November : Y, December : Z
- 4 Inspection date
- 5 Factory management code

6.7. Display (Display the following below every packing unit)

- 1. Customer's product name (if requested)
- 2. TDK product name
- 3. TDK item code
- 4. Inspection number
- 5. Quantity

* The label position on the reel

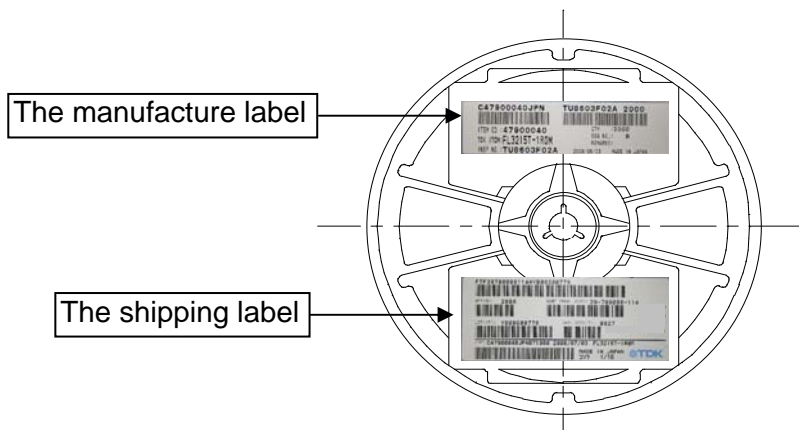

6.8. Packaging

Outer Box	Reel number	Dimension A	Dimension B	Dimension C
Type A	2 reel Max.	185 mm	195 mm	35 mm
Type B	4 reel Max.	185 mm	195 mm	60 mm
Type C	5 reel Max.	185 mm	195 mm	80 mm
Type D	10 reel Max.	185 mm	195 mm	155 mm

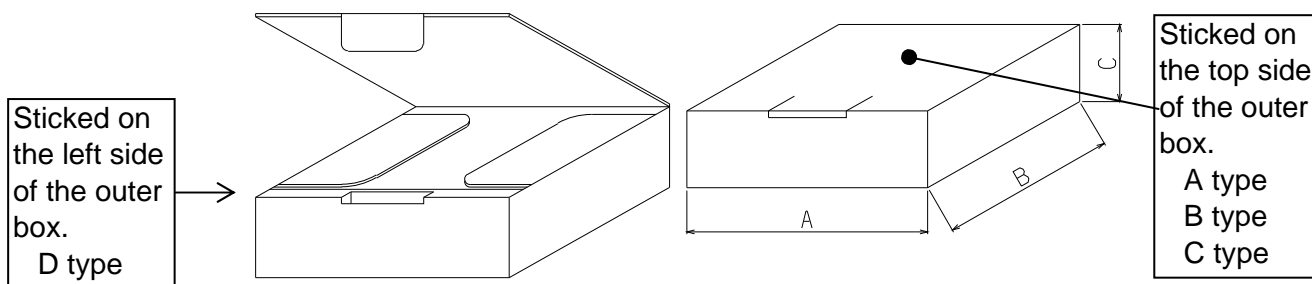

7. Recommended soldering conditions

7.1. Reflow soldering conditions

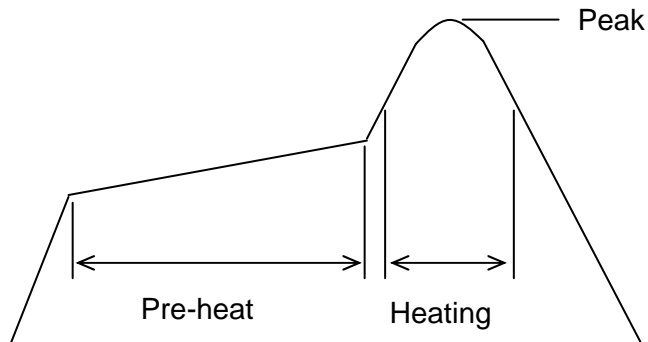

Item		Conditions	
Pre-heat Zone	temp.	150 to 180 deg C.	
	time	90 to 120	sec.
Heating Zone	temp.	230 deg C.	
	time	40 sec.	Max.
Peak Temperature	temp.	260 deg C.	Max.
	time	10 sec.	Max.
number of times		2	Max.

7.2. Flow soldering conditions

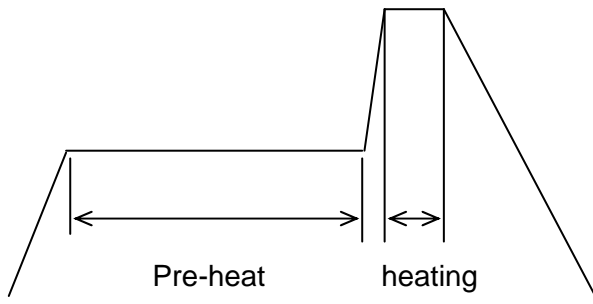

Item		Conditions	
Pre-heat Zone	temp.	150 to 170 deg C.	
	time	60 to 120	sec.
Heating Zone	temp.	260 deg C. Max.	
	time	10 sec.	Max.
number of times		2	Max.

7.3. Iron soldering condition

Iron tip temperature : 300 to 350 deg C
 heating time : 3 seconds / time
 Iron conditions : around 30W, tip diameter is around 1mm.

On these conditions, the product temperature must be less than 260 deg C.
 And the total heat treatment time must be less than 10 sec.

* About washing conditions

Solvent : Except for the strong acid or alkaline solvent is recommended.
 Method : soaking or showering is recommended.
 Time : Less than 2 minutes is recommended.