

Surface Mount Transient Voltage Suppressors (TVS)

SMBJ Series 5.0 To 440 V 600W

Description

The SMBJ series is designed specifically to protect sensitive electronic equipment from voltage transients induced by lightning and other transient voltage events.

Features

- u For surface mounted applications in order to optimize board space
- u Low leakage
- u Uni and Bidirectional unit
- u Glass passivated junction
- u Low inductance
- u Excellent clamping capability
- u 600W Peak power capability at 10 × 1000μs waveform Repetition rate (duty cycle):0.01%
- u Fast response time: typically less than 1.0ps from 0 Volts to V_{BR} min
- u Typical I_R less than 5μA above 12V.
- u High Temperature soldering: 260°C/40 seconds at terminals
- u Typical maximum temperature coefficient $\Delta V_{BR} = 0.1\% \times V_{BR@25^\circ C} \times \Delta T$
- u Plastic package has Underwriters Laboratory Flammability 94V-0
- u Matte tin lead-free Plated
- u Halogen free and RoHS compliant
- u Typical failure mode is short from over-specified voltage or current
- u Whisker test is conducted based on JEDEC JESD201A per its table 4a and 4c
- u IEC-61000-4-2 ESD 15kV(Air), 8kV (Contact)
- u ESD protection of data lines in accordance with IEC 61000-4-2 (IEC801-2)
- u EFT protection of data lines in accordance with IEC 61000-4-4 (IEC801-4)

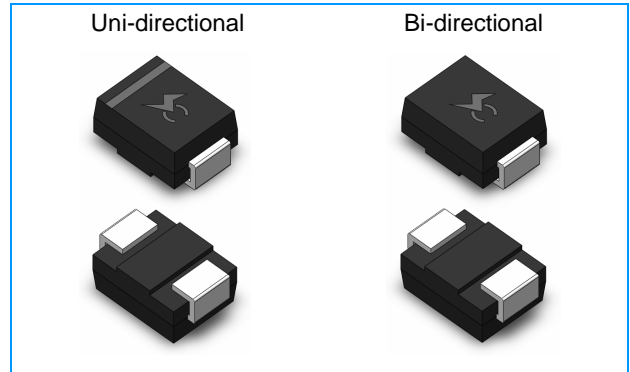

Functional Diagram



Agency Approvals

AGENCY	AGENCY FILE NUMBER
	E341027

Applications

TVS devices are ideal for the protection of I/O interfaces, V_{CC} bus and other vulnerable circuits used in Telecom, Computer, Industrial and Consumer electronic applications.

Maximum Ratings ($T_A=25^\circ C$ unless otherwise noted)

Parameter	Symbol	Value	Unit
Peak Pulse Power Dissipation with a 10/1000μs waveform (Fig.1)(Note 1), (Note 2)	P_{PPM}	600	Watts
Peak Pulse Current with a 10/1000μs waveform.(Note1, Fig.3)	I_{PP}	See Next Table	Amps
Power Dissipation on Infinite Heat Sink at $T_L=75^\circ C$	$P_{M(AV)}$	5.0	Watt
Peak Forward Surge Current, 8.3ms Single Half Sine Wave (Note 3)	I_{FSM}	100	Amps
Maximum Instantaneous Forward Voltage at 25A for Unidirectional Only (Note 4)	V_F	3.5/5.0	Voltage
Operating junction and Storage Temperature Range.	T_J, T_{STG}	-55 to +150	$^\circ C$

Notes:

1. Non-repetitive current pulse, per Fig. 3 and derated above $T_A = 25^\circ C$ per Fig. 2.
2. Mounted on 5.0mm x 5.0mm (0.03mm thick) Copper Pads to each terminal.
3. 8.3ms single half sine-wave, or equivalent square wave, Duty cycle = 4 pulses per minutes maximum.
4. $V_F < 3.5V$ for $V_{BR} < 200V$ and $V_F < 6.5V$ for $V_{BR} > 201V$.

Surface Mount Transient Voltage Suppressors (TVS)

SMBJ Series 5.0 To 440 V 600W
Electrical Characteristics (T_A=25°C unless otherwise noted)

Part Number		Marking		Reverse Stand-Off Voltage V _{RWM} (V)	Breakdown Voltage V _{BR} (V) @I _T		Test Current I _T (mA)	Maximum Clamping Voltage V _C @I _{PP} (V)	Maximum Peak Pulse Current I _{PP} (A)	Maximum Reverse Leakage I _R @V _{RWM} (μA)
Uni	Bi	Uni	Bi		MIN	MAX				
SMBJ5.0	SMBJ5.0C	KD	AD	5.0	6.40	7.30	10	9.6	62.50	800
SMBJ5.0A	SMBJ5.0CA	KE	AE	5.0	6.40	7.00	10	9.2	65.22	800
SMBJ6.0	SMBJ6.0C	KF	AF	6.0	6.67	8.15	10	11.4	52.63	800
SMBJ6.0A	SMBJ6.0CA	KG	AG	6.0	6.67	7.37	10	10.3	58.25	800
SMBJ6.5	SMBJ6.5C	KH	AH	6.5	7.22	8.82	10	12.3	48.78	500
SMBJ6.5A	SMBJ6.5CA	KK	AK	6.5	7.22	7.98	10	11.2	53.57	500
SMBJ7.0	SMBJ7.0C	KL	AL	7.0	7.78	9.51	10	13.3	45.11	200
SMBJ7.0A	SMBJ7.0CA	KM	AM	7.0	7.78	8.60	10	12.0	50.00	200
SMBJ7.5	SMBJ7.5C	KN	AN	7.5	8.33	10.20	1	14.3	41.96	100
SMBJ7.5A	SMBJ7.5CA	KP	AP	7.5	8.33	9.21	1	12.9	46.51	100
SMBJ8.0	SMBJ8.0C	KQ	AQ	8.0	8.89	10.90	1	15.0	40.00	50
SMBJ8.0A	SMBJ8.0CA	KR	AR	8.0	8.89	9.83	1	13.6	44.12	50
SMBJ8.5	SMBJ8.5C	KS	AS	8.5	9.44	11.50	1	15.9	37.74	10
SMBJ8.5A	SMBJ8.5CA	KT	AT	8.5	9.44	10.40	1	14.4	41.67	10
SMBJ9.0	SMBJ9.0C	KU	AU	9.0	10.00	12.20	1	16.9	35.50	5
SMBJ9.0A	SMBJ9.0CA	KV	AV	9.0	10.00	11.10	1	15.4	38.96	5
SMBJ10	SMBJ10C	KW	AA	10.0	11.10	13.60	1	18.8	31.91	5
SMBJ10A	SMBJ10CA	KX	AX	10.0	11.10	12.30	1	17.0	35.29	5
SMBJ11	SMBJ11C	KY	AY	11.0	12.20	14.90	1	20.1	29.85	5
SMBJ11A	SMBJ11CA	KZ	WZ	11.0	12.20	13.50	1	18.2	32.97	5
SMBJ12	SMBJ12C	LD	BD	12.0	13.30	16.30	1	22.0	27.27	5
SMBJ12A	SMBJ12CA	LE	BE	12.0	13.30	14.70	1	19.9	30.15	5
SMBJ13	SMBJ13C	LF	BF	13.0	14.40	17.60	1	23.8	25.21	5
SMBJ13A	SMBJ13CA	LG	BG	13.0	14.40	15.90	1	21.5	27.91	5
SMBJ14	SMBJ14C	LH	BH	14.0	15.60	19.10	1	25.8	23.26	5
SMBJ14A	SMBJ14CA	LK	BK	14.0	15.60	17.20	1	23.2	25.86	5
SMBJ15	SMBJ15C	LL	BL	15.0	16.70	20.40	1	26.9	22.30	5
SMBJ15A	SMBJ15CA	LM	BM	15.0	16.70	18.50	1	24.4	24.59	5
SMBJ16	SMBJ16C	LN	BN	16.0	17.80	21.80	1	28.8	20.83	5
SMBJ16A	SMBJ16CA	LP	BP	16.0	17.80	19.70	1	26.0	23.08	5
SMBJ17	SMBJ17C	LQ	BQ	17.0	18.90	23.10	1	30.5	19.67	5
SMBJ17A	SMBJ17CA	LR	BR	17.0	18.90	20.90	1	27.6	21.74	5
SMBJ18	SMBJ18C	LS	BS	18.0	20.00	24.40	1	32.2	18.63	5
SMBJ18A	SMBJ18CA	LT	BT	18.0	20.00	22.10	1	29.2	20.55	5
SMBJ19	SMBJ19C	LA	BA	19.0	21.13	25.76	1	34.0	17.64	5
SMBJ19A	SMBJ19CA	LB	BB	19.0	21.10	23.30	1	30.8	19.49	5
SMBJ20	SMBJ20C	LU	BU	20.0	22.20	27.10	1	35.8	16.67	5
SMBJ20A	SMBJ20CA	LV	BV	20.0	22.20	24.50	1	32.4	18.52	5
SMBJ22	SMBJ22C	LW	BW	22.0	24.40	29.80	1	39.4	15.23	5
SMBJ22A	SMBJ22CA	LX	BX	22.0	24.40	26.90	1	35.5	16.90	5
SMBJ24	SMBJ24C	LY	BY	24.0	26.70	32.60	1	43.0	13.95	5
SMBJ24A	SMBJ24CA	LZ	BZ	24.0	26.70	29.50	1	38.9	15.42	5
SMBJ26	SMBJ26C	MD	CD	26.0	28.90	35.30	1	46.6	12.88	5
SMBJ26A	SMBJ26CA	ME	CE	26.0	28.90	31.90	1	42.1	14.25	5
SMBJ28	SMBJ28C	MF	CF	28.0	31.10	38.00	1	50.0	12.00	5
SMBJ28A	SMBJ28CA	MG	CG	28.0	31.10	34.40	1	45.4	13.22	5
SMBJ30	SMBJ30C	MH	CH	30.0	33.30	40.70	1	53.5	11.21	5
SMBJ30A	SMBJ30CA	MK	CK	30.0	33.30	36.80	1	48.4	12.40	5
SMBJ33	SMBJ33C	ML	CL	33.0	36.70	44.90	1	59.0	10.17	5
SMBJ33A	SMBJ33CA	MM	CM	33.0	36.70	40.60	1	53.3	11.26	5
SMBJ36	SMBJ36C	MN	CN	36.0	40.00	48.90	1	64.3	9.33	5
SMBJ36A	SMBJ36CA	MP	CP	36.0	40.00	44.20	1	58.1	10.33	5
SMBJ40	SMBJ40C	MQ	CQ	40.0	44.40	54.30	1	71.4	8.40	5
SMBJ40A	SMBJ40CA	MR	CR	40.0	44.40	49.10	1	64.5	9.30	5
SMBJ43	SMBJ43C	MS	CS	43.0	47.80	58.40	1	76.7	7.82	5
SMBJ43A	SMBJ43CA	MT	CT	43.0	47.80	52.80	1	69.4	8.65	5

Surface Mount Transient Voltage Suppressors (TVS)

SMBJ Series 5.0 To 440 V 600W
Electrical Characteristics (T_A=25°C unless otherwise noted) (Continue)

Part Number		Marking		Reverse Stand-Off Voltage V _{RWM} (V)	Breakdown Voltage V _{BR} (V) @I _T		Test Current I _T (mA)	Maximum Clamping Voltage V _C @I _{PP} (V)	Maximum Peak Pulse Current I _{PP} (A)	Maximum Reverse Leakage I _R @V _{RWM} (μA)
Uni	Bi	Uni	Bi		MIN	MAX				
SMBJ45	SMBJ45C	MU	CU	45.0	50.00	61.10	1	80.3	7.47	5
SMBJ45A	SMBJ45CA	MV	CV	45.0	50.00	55.30	1	72.7	8.25	5
SMBJ48	SMBJ48C	MW	CW	48.0	53.30	65.10	1	85.5	7.02	5
SMBJ48A	SMBJ48CA	MX	CX	48.0	53.30	58.90	1	77.4	7.75	5
SMBJ51	SMBJ51C	MY	CY	51.0	56.70	69.30	1	91.1	6.59	5
SMBJ51A	SMBJ51CA	MZ	CZ	51.0	56.70	62.70	1	82.4	7.28	5
SMBJ54	SMBJ54C	ND	DD	54.0	60.00	73.30	1	96.3	6.23	5
SMBJ54A	SMBJ54CA	NE	DE	54.0	60.00	66.30	1	87.1	6.89	5
SMBJ58	SMBJ58C	NF	DF	58.0	64.40	78.70	1	103.0	5.83	5
SMBJ58A	SMBJ58CA	NG	DG	58.0	64.40	71.20	1	93.6	6.41	5
SMBJ60	SMBJ60C	NH	DH	60.0	66.70	81.50	1	107.0	5.61	5
SMBJ60A	SMBJ60CA	NK	DK	60.0	66.70	73.70	1	96.8	6.20	5
SMBJ64	SMBJ64C	NL	DL	64.0	71.10	86.90	1	114.0	5.26	5
SMBJ64A	SMBJ64CA	NM	DM	64.0	71.10	78.60	1	103.0	5.83	5
SMBJ70	SMBJ70C	NN	DN	70.0	77.80	95.10	1	125.0	4.80	5
SMBJ70A	SMBJ70CA	NP	DP	70.0	77.80	86.00	1	113.0	5.31	5
SMBJ75	SMBJ75C	NQ	DQ	75.0	83.30	102.00	1	134.0	4.48	5
SMBJ75A	SMBJ75CA	NR	DR	75.0	83.30	92.10	1	121.0	4.96	5
SMBJ78	SMBJ78C	NS	DS	78.0	86.70	106.00	1	139.0	4.32	5
SMBJ78A	SMBJ78CA	NT	DT	78.0	86.70	95.80	1	126.0	4.76	5
SMBJ80	SMBJ80C	NA	DA	80.0	88.96	108.80	1	143.2	4.19	5
SMBJ80A	SMBJ80CA	NB	DB	80.0	88.80	97.60	1	129.6	4.63	5
SMBJ85	SMBJ85C	NU	DU	85.0	94.40	115.00	1	151.0	3.97	5
SMBJ85A	SMBJ85CA	NV	DV	85.0	94.40	104.00	1	137.0	4.38	5
SMBJ90	SMBJ90C	NW	DW	90.0	100.00	122.00	1	160.0	3.75	5
SMBJ90A	SMBJ90CA	NX	DX	90.0	100.00	111.00	1	146.0	4.11	5
SMBJ100	SMBJ100C	NY	DY	100.0	111.00	136.00	1	179.0	3.35	5
SMBJ100A	SMBJ100CA	NZ	DZ	100.0	111.00	123.00	1	162.0	3.70	5
SMBJ110	SMBJ110C	PD	ED	110.0	122.00	149.00	1	196.0	3.06	5
SMBJ110A	SMBJ110CA	PE	EE	110.0	122.00	135.00	1	177.0	3.39	5
SMBJ120	SMBJ120C	PF	EF	120.0	133.00	163.00	1	214.0	2.80	5
SMBJ120A	SMBJ120CA	PG	EG	120.0	133.00	147.00	1	193.0	3.11	5
SMBJ130	SMBJ130C	PH	EH	130.0	144.00	176.00	1	231.0	2.60	5
SMBJ130A	SMBJ130CA	PK	EK	130.0	144.00	159.00	1	209.0	2.87	5
SMBJ140	SMBJ140C	PA	EA	140.0	155.68	190.40	1	250.6	2.39	5
SMBJ140A	SMBJ140CA	PB	EB	140.0	155.00	171.00	1	226.8	2.65	5
SMBJ150	SMBJ150C	PL	EL	150.0	167.00	204.00	1	268.0	2.24	5
SMBJ150A	SMBJ150CA	PM	EM	150.0	167.00	185.00	1	243.0	2.47	5
SMBJ160	SMBJ160C	PN	EN	160.0	178.00	218.00	1	287.0	2.09	5
SMBJ160A	SMBJ160CA	PP	EP	160.0	178.00	197.00	1	259.0	2.32	5
SMBJ170	SMBJ170C	PQ	EQ	170.0	189.00	231.00	1	304.0	1.97	5
SMBJ170A	SMBJ170CA	PR	ER	170.0	189.00	209.00	1	275.0	2.18	5
SMBJ180	SMBJ180C	PS	ES	180.0	201.00	244.80	1	322.2	1.86	5
SMBJ180A	SMBJ180CA	PT	ET	180.0	201.00	220.00	1	291.6	2.06	5
SMBJ190	SMBJ190C	PU	EU	190.0	211.21	258.40	1	340.1	1.76	5
SMBJ190A	SMBJ190CA	PV	EV	190.0	211.00	232.00	1	307.8	1.95	5
SMBJ200A	SMBJ200CA	PW	EW	200.0	224.00	247.00	1	324.0	1.85	5
SMBJ220A	SMBJ220CA	PX	EX	220.0	246.00	272.00	1	356.0	1.69	5
SMBJ250A	SMBJ250CA	PZ	EZ	250.0	279.00	309.00	1	405.0	1.48	5
SMBJ300A	SMBJ300CA	QE	FE	300.0	335.00	371.00	1	486.0	1.23	5
SMBJ350A	SMBJ350CA	QG	FG	350.0	391.00	432.00	1	567.0	1.06	5
SMBJ400A	SMBJ400CA	QK	FK	400.0	447.00	494.00	1	648.0	0.93	5
SMBJ440A	SMBJ440CA	QM	FM	440.0	492.00	543.00	1	713.0	0.84	5

Note:

1. Suffix 'A' denotes 5% tolerance device. Without 'A' denotes 10% tolerance device
2. Add suffix 'C' or 'CA' after part number to specify Bi-directional devices
3. For Bi-Directional devices having V_R of 10 volts and under, the I_R limit is double

Surface Mount Transient Voltage Suppressors (TVS)

SMBJ Series 5.0 To 440 V 600W

Ratings and Characteristic Curves ($T_A=25^\circ\text{C}$ unless otherwise noted)

Figure 1 - Peak Pulse Power Rating Curve

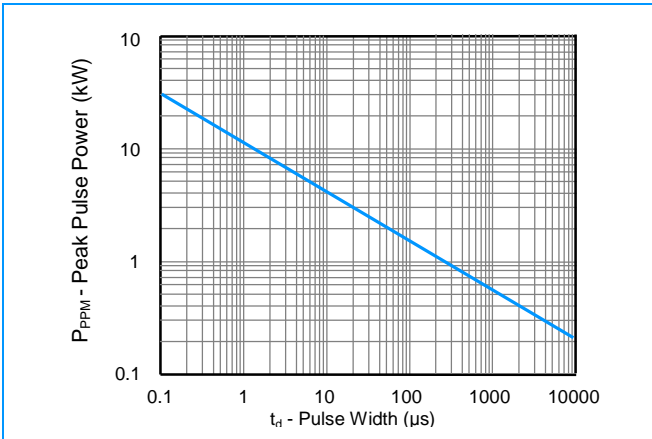

Figure 2 - Pulse Derating Curve



Figure 3 - Pulse Waveform

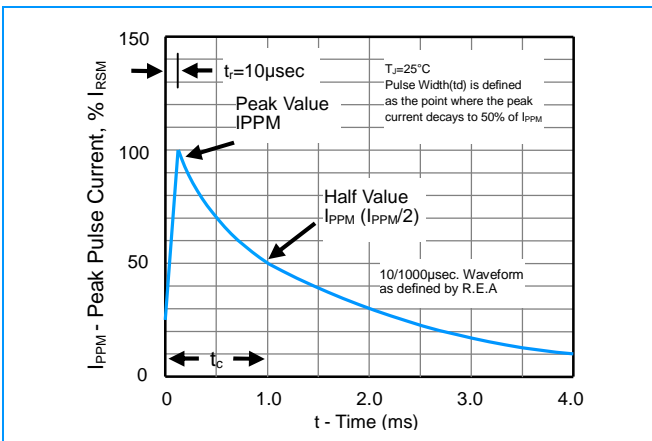

Figure 4 - Typical Junction Capacitance

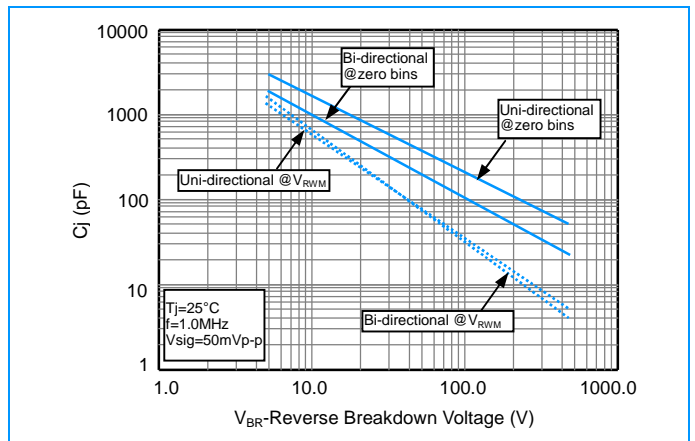

Figure 5 - Steady State Power Derating Curve

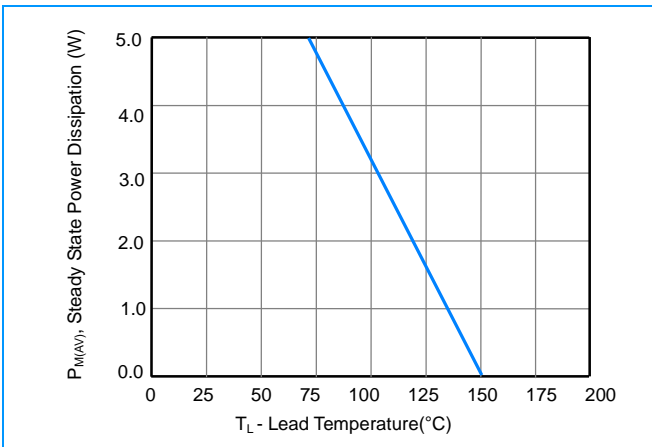
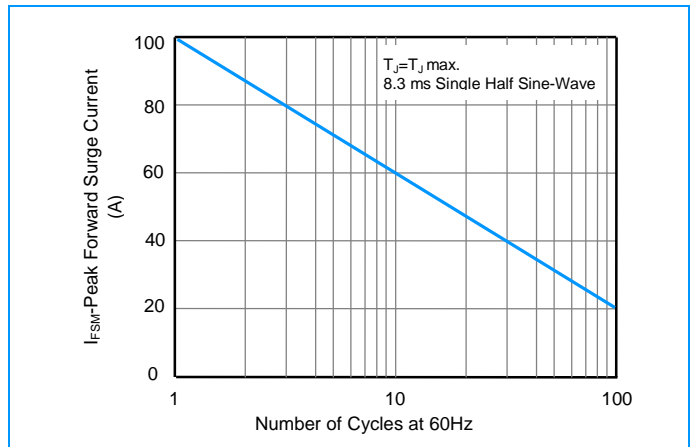

Figure 6 - Maximum Non-Repetitive Surge Current



Surface Mount Transient Voltage Suppressors (TVS)

SMBJ Series 5.0 To 440 V 600W

I-V Curve Characteristics

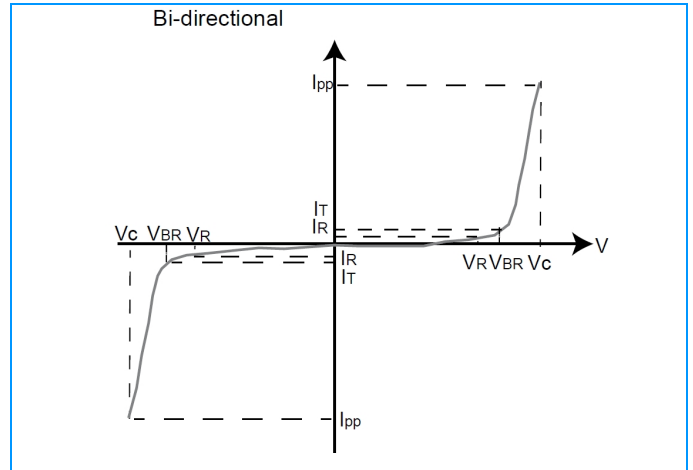
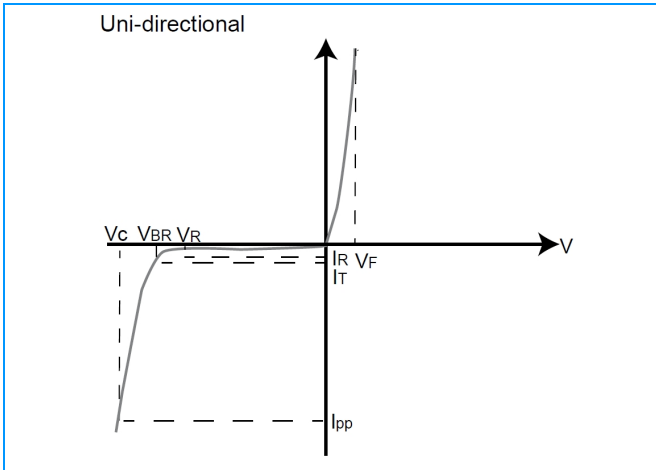

Physical Specifications

Weight	0.003 ounce, 0.093 gram
Case	JEDEC DO-214AA Molded Plastic over glass passivated junction
Polarity	Color band denotes cathode except Bipolar
Terminal	Matte Tin-plated leads, Solderable per JESD22-B102D

Environmental Specifications

Temperature Cycle	JESD22-A104
Pressure Cooker	JESD22-A102
High Temp. Storage	JESD22-A103
HTRB	JESD22-A108
Thermal Shock	JESD22-A106

Soldering Parameters

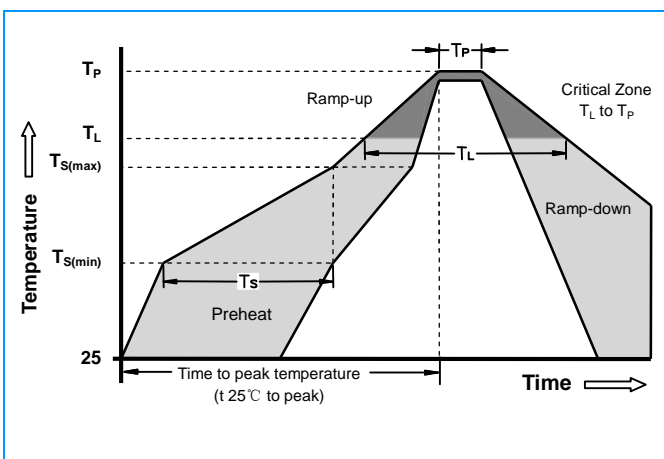

Reflow Condition		Lead-free assembly
Pre Heat	- Temperature Min ($T_{s(min)}$)	150°C
	- Temperature Max ($T_{s(max)}$)	200°C
	- Time (min to max) (t_s)	60 - 180 Seconds
Average ramp up rate (Liquidus Temp T_L) to peak		3°C/second max
$T_{s(max)}$ to T_L - Ramp-up Rate		3°C/second max
Reflow	- Temperature (T_L) (Liquidus)	217°C
	- Time (min to max) (t_s)	60 - 150 Seconds
Peak Temperature (T_P)		260 +0/-5°C
Time within 5°C of actual peak Temperature (t_p)		20 - 40 Seconds
Ramp-down Rate		6°C/second max
Time 25°C to peak Temperature (T_P)		8 minutes Max
Do not exceed		280°C

Surface Mount Transient Voltage Suppressors (TVS)

SMBJ Series 5.0 To 440 V 600W

Dimensions

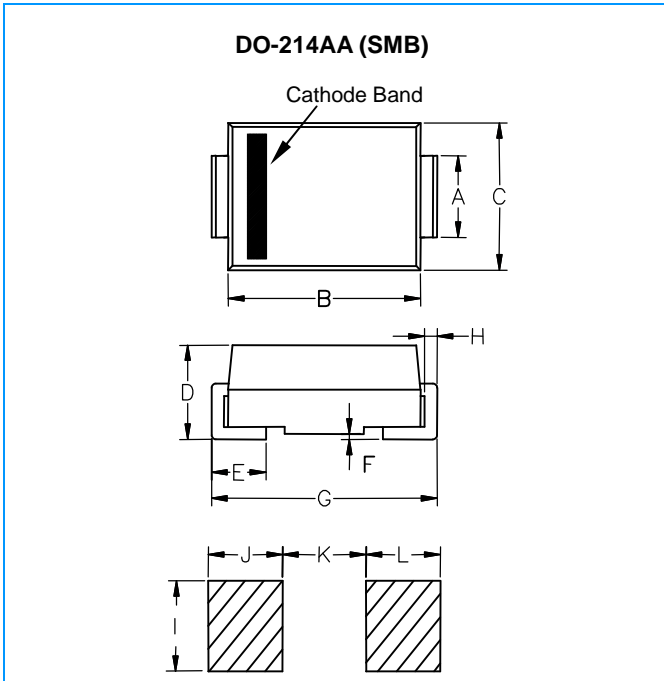

Dimensions	Inches		Millimeters	
	Min	Max	Min	Max
A	0.077	0.087	1.960	2.200
B	0.171	0.191	4.350	4.850
C	0.130	0.155	3.300	3.940
D	0.084	0.096	2.130	2.440
E	0.030	0.060	0.750	1.520
F	-	0.008	-	0.203
G	0.201	0.216	5.100	5.500
H	0.006	0.012	0.152	0.305
I	0.089	-	2.260	-
J	0.085	-	2.160	-
K	-	0.107	-	2.740
L	0.085	-	2.160	-

Part Numbering

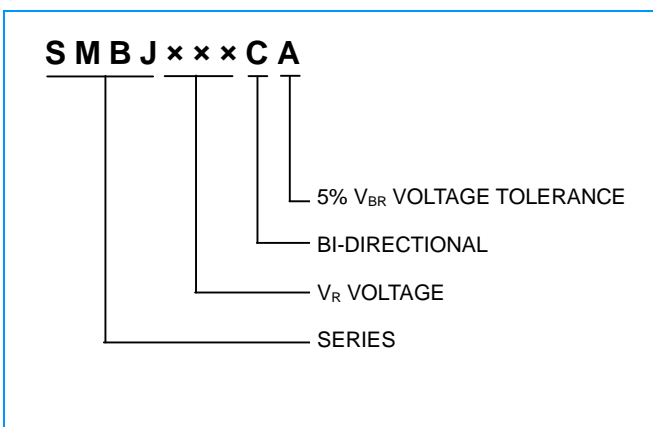

Part Marking

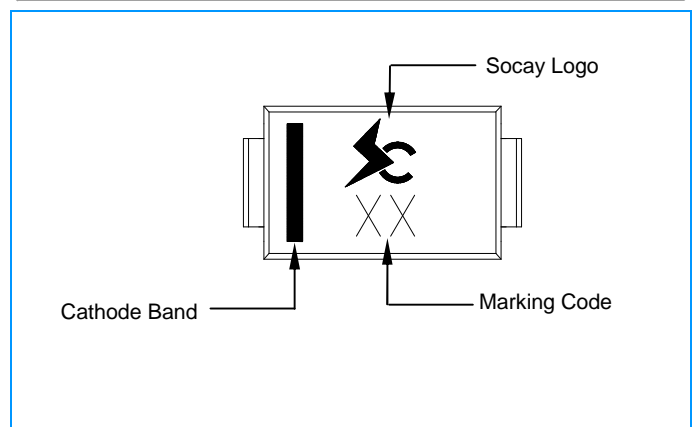

Surface Mount Transient Voltage Suppressors (TVS)

SMBJ Series 5.0 To 440 V 600W

Packaging

Part Number	Component Package	Quantity	Packaging Option	Packaging Specification
SMBJXXXXX	DO-214AA	500	Tape & Reel -12mm/7"tape	EIA STD RS-481

Tape and Reel Specifications

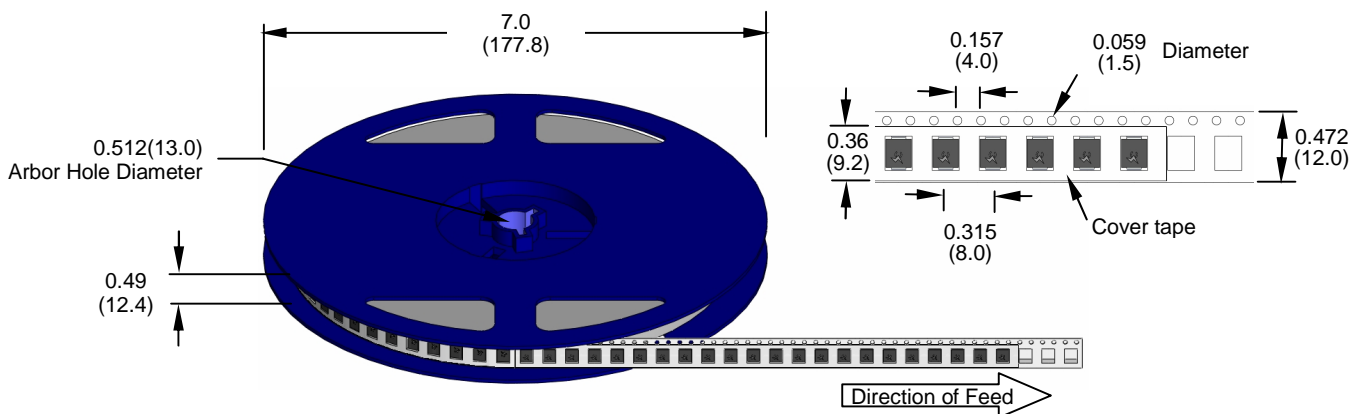

Dimensions are in inches
(and millimeters)