

ESD9R3.3S, SZESD9R3.3S

Transient Voltage Suppressors

ESD Protection Diodes with Ultra-Low Leakage

The ESD9R is designed to provide ESD protection for ASSPs and ASICs used in ultra low current applications such as human body sensors. These devices have been designed for leakage under 1 nA from 0°C to 50°C when turned off. During an ESD event, these devices turn on to clamp the ESD to a safe voltage level for the IC. These devices have the added benefits of low capacitance for high speed data lines and small package size for space constrained designs.

Specification Features:

- Ultra-Low Leakage < 1 nA
- Ultra-Low Capacitance 0.5 pF
- Low Clamping Voltage
- Small Body Outline Dimensions:
0.039" x 0.024" (1.00 mm x 0.60 mm)
- Low Body Height: 0.016" (0.4 mm)
- Stand-off Voltage: 3.3 V
- Response Time < 1.0 ns
- IEC61000-4-2 Level 4 ESD Protection
- SZ Prefix for Automotive and Other Applications Requiring Unique Site and Control Change Requirements; AEC-Q101 Qualified and PPAP Capable
- This is a Pb-Free and Halogen-Free Device

Mechanical Characteristics:

CASE: Void-free, transfer-molded, thermosetting plastic

Epoxy Meets UL 94 V-0

LEAD FINISH: 100% Matte Sn (Tin)

MOUNTING POSITION: Any

QUALIFIED MAX REFLOW TEMPERATURE: 260°C

Device Meets MSL 1 Requirements

MAXIMUM RATINGS

Rating	Symbol	Value	Unit
IEC 61000-4-2 (ESD) Contact Air HBM		±10 ±15 ±16	kV
Total Power Dissipation on FR-5 Board (Note 1) @ T _A = 25°C	P _D	150	mW
Storage Temperature Range	T _{stg}	-55 to +150	°C
Junction Temperature Range	T _J	-55 to +125	°C
Lead Solder Temperature - Maximum (10 Second Duration)	T _L	260	°C

Stresses exceeding Maximum Ratings may damage the device. Maximum Ratings are stress ratings only. Functional operation above the Recommended Operating Conditions is not implied. Extended exposure to stresses above the Recommended Operating Conditions may affect device reliability.

1. FR-5 = 1.0 x 0.75 x 0.62 in.

See Application Note AND8308/D for further description of survivability specs.



ON Semiconductor®

<http://onsemi.com>



SOD-923
CASE 514AB

MARKING DIAGRAM

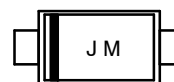

J = Specific Device Code

M = Date Code

*Date Code orientation and/or position may vary depending upon manufacturing location.

ORDERING INFORMATION

Device	Package	Shipping†
ESD9R3.3ST5G	SOD-923 (Pb-Free)	8000 / Tape & Reel
SZESD9R3.3ST5G	SOD-923 (Pb-Free)	8000 / Tape & Reel

†For information on tape and reel specifications, including part orientation and tape sizes, please refer to our Tape and Reel Packaging Specifications Brochure, BRD8011/D.

DEVICE MARKING INFORMATION

See specific marking information in the device marking column of the Electrical Characteristics tables starting on page 2 of this data sheet.

ESD9R3.3S, SZESD9R3.3S

ELECTRICAL CHARACTERISTICS

($T_A = 25^\circ\text{C}$ unless otherwise noted)

Symbol	Parameter
I_{PP}	Maximum Reverse Peak Pulse Current
V_C	Clamping Voltage @ I_{PP}
V_{RWM}	Working Peak Reverse Voltage
I_R	Maximum Reverse Leakage Current @ V_{RWM}
V_{BR}	Breakdown Voltage @ I_T
I_T	Test Current
I_F	Forward Current
V_F	Forward Voltage @ I_F
P_{pk}	Peak Power Dissipation
C	Max. Capacitance @ $V_R = 0$ and $f = 1.0$ MHz

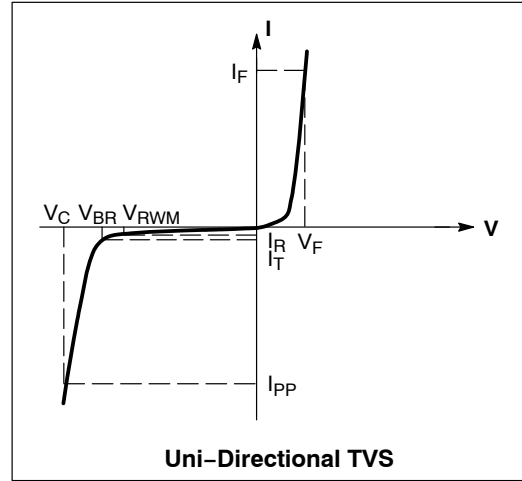

*See Application Note AND8308/D for detailed explanations of datasheet parameters.

ELECTRICAL CHARACTERISTICS ($T_A = 25^\circ\text{C}$ unless otherwise noted, $V_F = 1.0$ V Max. @ $I_F = 10$ mA for all types)

Device*	Device Marking	V_{RWM} (V)	I_R (nA) @ 1 V $T_A = 0^\circ\text{C}$ to 50°C (Note 4)	V_{BR} (V) @ I_T (Note 2)	I_T	C (pF)		V_C (V) @ $I_{PP} = 1$ A (Note 5)	V_C
		Max	Max	Min	mA	Typ	Max	Max	Per IEC61000-4-2 (Note 3)
ESD9R3.3ST5G	J**	3.3	1.0	4.8	1.0	0.5	0.9	7.8	Figures 1 and 2 See Below

*Includes SZ-prefix device where applicable.

**Rotated 270° .

- V_{BR} is measured with a pulse test current I_T at an ambient temperature of 25°C .
- For test procedure see Figures 3 and 4 and Application Note AND8307/D.
- Limits over temperature are guaranteed by design, not production tested.
- V_C measured using pulse waveform in Figure 5.

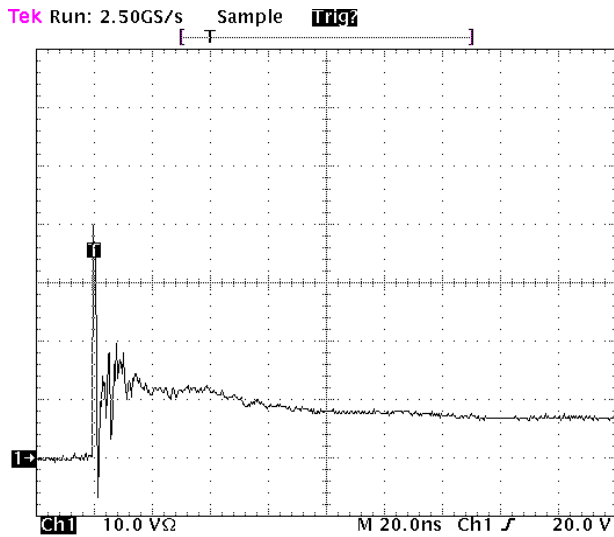

Figure 1. ESD Clamping Voltage Screenshot Positive 8 kV Contact per IEC61000-4-2

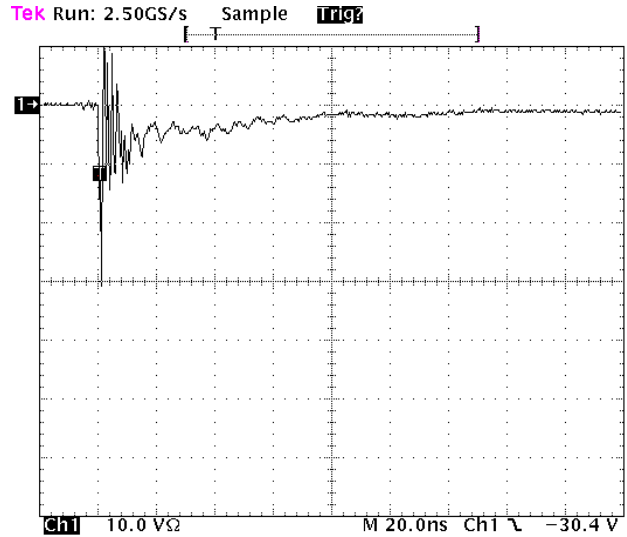

Figure 2. ESD Clamping Voltage Screenshot Negative 8 kV Contact per IEC61000-4-2

ESD9R3.3S, SZESD9R3.3S

IEC 61000-4-2 Spec.

Level	Test Voltage (kV)	First Peak Current (A)	Current at 30 ns (A)	Current at 60 ns (A)
1	2	7.5	4	2
2	4	15	8	4
3	6	22.5	12	6
4	8	30	16	8

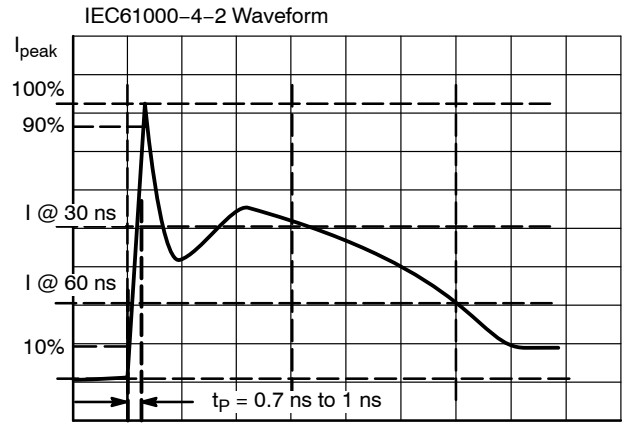

Figure 3. IEC61000-4-2 Spec

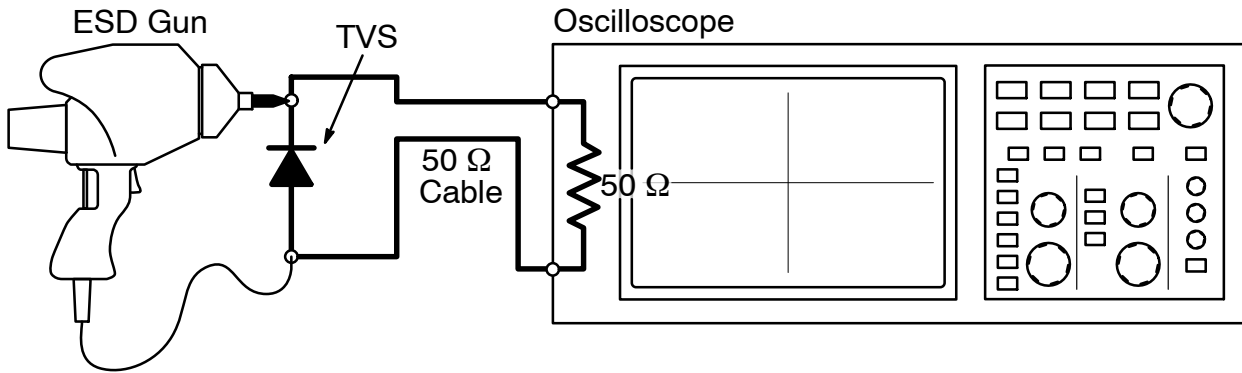

Figure 4. Diagram of ESD Test Setup

The following is taken from Application Note AND8308/D – Interpretation of Datasheet Parameters for ESD Devices.

ESD Voltage Clamping

For sensitive circuit elements it is important to limit the voltage that an IC will be exposed to during an ESD event to as low a voltage as possible. The ESD clamping voltage is the voltage drop across the ESD protection diode during an ESD event per the IEC61000-4-2 waveform. Since the IEC61000-4-2 was written as a pass/fail spec for larger

systems such as cell phones or laptop computers it is not clearly defined in the spec how to specify a clamping voltage at the device level. ON Semiconductor has developed a way to examine the entire voltage waveform across the ESD protection diode over the time domain of an ESD pulse in the form of an oscilloscope screenshot, which can be found on the datasheets for all ESD protection diodes. For more information on how ON Semiconductor creates these screenshots and how to interpret them please refer to AND8307/D.

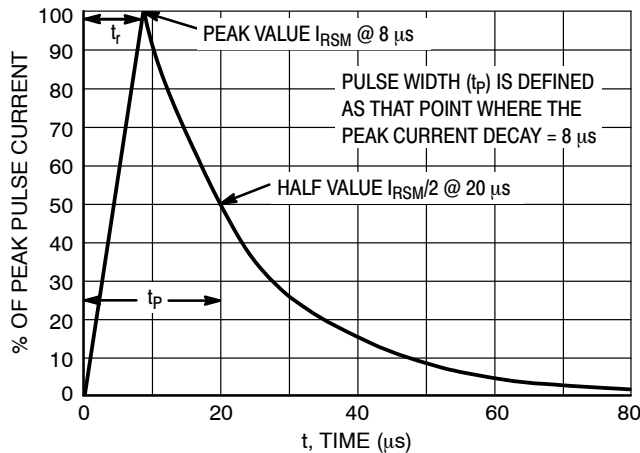
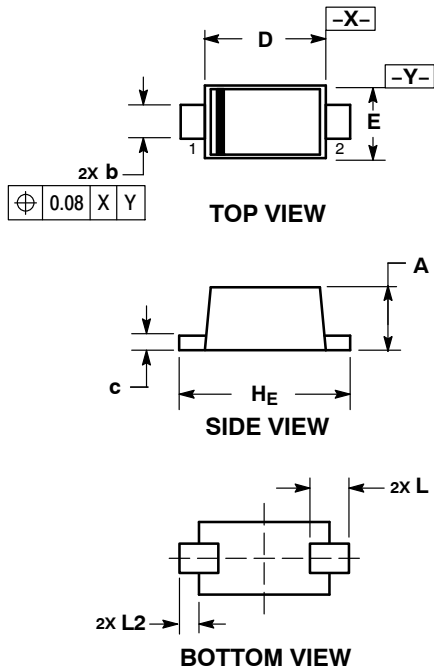

Figure 5. 8 X 20 μs Pulse Waveform

ESD9R3.3S, SZESD9R3.3S

PACKAGE DIMENSIONS

SOD-923
CASE 514AB
ISSUE C



NOTES:

1. DIMENSIONING AND TOLERANCING PER ASME Y14.5M, 1994.
2. CONTROLLING DIMENSION: MILLIMETERS.
3. MAXIMUM LEAD THICKNESS INCLUDES LEAD FINISH. MINIMUM LEAD THICKNESS IS THE MINIMUM THICKNESS OF BASE MATERIAL.
4. DIMENSIONS D AND E DO NOT INCLUDE MOLD FLASH, PROTRUSIONS, OR GATE BURRS.

DIM	MILLIMETERS			INCHES		
	MIN	NOM	MAX	MIN	NOM	MAX
A	0.34	0.37	0.40	0.013	0.015	0.016
b	0.15	0.20	0.25	0.006	0.008	0.010
c	0.07	0.12	0.17	0.003	0.005	0.007
D	0.75	0.80	0.85	0.030	0.031	0.033
E	0.55	0.60	0.65	0.022	0.024	0.026
H _E	0.95	1.00	1.05	0.037	0.039	0.041
L	0.19 REF			0.007 REF		
L ₂	0.05	0.10	0.15	0.002	0.004	0.006

SOLDERING FOOTPRINT*

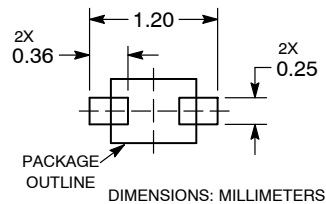

See Application Note AND8455/D for more mounting details

*For additional information on our Pb-Free strategy and soldering details, please download the ON Semiconductor Soldering and Mounting Techniques Reference Manual, SOLDERRM/D.

ON Semiconductor and are registered trademarks of Semiconductor Components Industries, LLC (SCILLC). SCILLC owns the rights to a number of patents, trademarks, copyrights, trade secrets, and other intellectual property. A listing of SCILLC's product/patent coverage may be accessed at www.onsemi.com/site/pdf/Patent-Marking.pdf. SCILLC reserves the right to make changes without further notice to any products herein. SCILLC makes no warranty, representation or guarantee regarding the suitability of its products for any particular purpose, nor does SCILLC assume any liability arising out of the application or use of any product or circuit, and specifically disclaims any and all liability, including without limitation special, consequential or incidental damages. "Typical" parameters which may be provided in SCILLC data sheets and/or specifications can and do vary in different applications and actual performance may vary over time. All operating parameters, including "Typicals" must be validated for each customer application by customer's technical experts. SCILLC does not convey any license under its patent rights nor the rights of others. SCILLC products are not designed, intended, or authorized for use as components in systems intended for surgical implant into the body, or other applications intended to support or sustain life, or for any other application in which the failure of the SCILLC product could create a situation where personal injury or death may occur. Should Buyer purchase or use SCILLC products for any such unintended or unauthorized application, Buyer shall indemnify and hold SCILLC and its officers, employees, subsidiaries, affiliates, and distributors harmless against all claims, costs, damages, and expenses, and reasonable attorney fees arising out of, directly or indirectly, any claim of personal injury or death associated with such unintended or unauthorized use, even if such claim alleges that SCILLC was negligent regarding the design or manufacture of the part. SCILLC is an Equal Opportunity/Affirmative Action Employer. This literature is subject to all applicable copyright laws and is not for resale in any manner.

PUBLICATION ORDERING INFORMATION

LITERATURE FULFILLMENT:
Literature Distribution Center for ON Semiconductor
P.O. Box 5163, Denver, Colorado 80217 USA
Phone: 303-675-2175 or 800-344-3860 Toll Free USA/Canada
Fax: 303-675-2176 or 800-344-3867 Toll Free USA/Canada
Email: orderlit@onsemi.com

N. American Technical Support: 800-282-9855 Toll Free
USA/Canada
Europe, Middle East and Africa Technical Support:
Phone: 421 33 790 2910
Japan Customer Focus Center
Phone: 81-3-5817-1050

ON Semiconductor Website: www.onsemi.com
Order Literature: <http://www.onsemi.com/orderlit>

For additional information, please contact your local Sales Representative