

Package: Ceramic QFN, 40-pin, 6mm x 6mm x 0.95mm



Features

- Frequency Range: 17.7GHz to 19.7GHz
- Small Signal Gain: 25dB
- IM3 at +17dBm (SCL): +52dBc
- IM3 at +21dBm (SCL): +43dBc
- IM3 at +24dBm (SCL): +32.5dBc
- OIP3 at +24dBm (SCL): +40dBm
- P1dB: +31dBm
- RL (Input): 12dB
- RL (Output): 8dB
- V_D : 5.5V
- I_D : 1.3A
- 6mm x 6mm QFN

Applications

- Point-Point Radio
- Point-Multipoint Radio

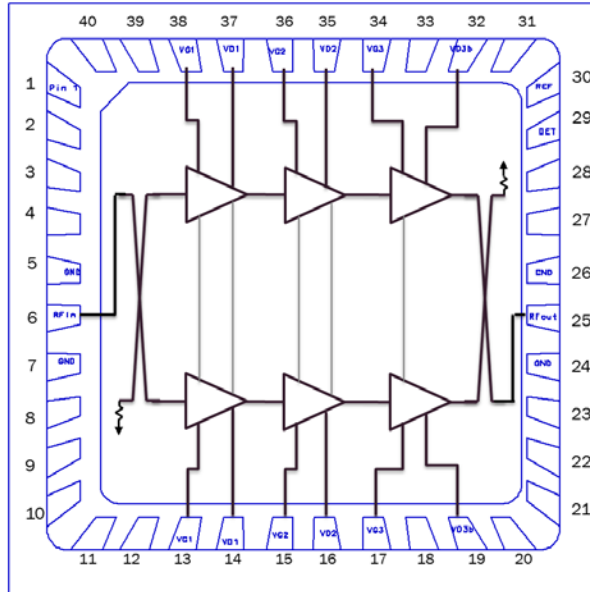

Functional Block Diagram

Product Description

RFMD's RFPA1702 is a high linearity power amplifier in a surface mount package designed for use in transmitters that operate at frequencies between 17.7GHz to 19.7GHz. It provides 25dB of small-signal gain. This power amplifier is optimized for linear operation with an output third order intercept point (OIP3) of $\geq +40.0$ dBm. The RFPA1702 is manufactured with depletion mode GaAs pHEMT process.

Ordering Information

RFPA1702S2	2-Piece sample bag
RFPA1702SB	5-Piece bag
RFPA1702SQ	25-Piece bag
RFPA1702SR	100-Piece reel
RFPA1702TR7	750-Piece 7" reel
RFPA1702PCBA-410	Evaluation Board

Optimum Technology Matching® Applied

- | | | | |
|--------------------------------------|--------------------------------------|--|------------------------------------|
| <input type="checkbox"/> GaAs HBT | <input type="checkbox"/> SiGe BiCMOS | <input checked="" type="checkbox"/> GaAs pHEMT | <input type="checkbox"/> GaN HEMT |
| <input type="checkbox"/> GaAs MESFET | <input type="checkbox"/> Si BiCMOS | <input type="checkbox"/> Si CMOS | <input type="checkbox"/> BiFET HBT |
| <input type="checkbox"/> InGaP HBT | <input type="checkbox"/> SiGe HBT | <input type="checkbox"/> Si BJT | |

RF MICRO DEVICES®, RFMD®, Optimum Technology Matching®, Enabling Wireless Connectivity™, PowerStar®, POLARIS™ TOTAL RADIO™ and UltimateBlue™ are trademarks of RFMD, LLC. BLUETOOTH is a trademark owned by Bluetooth SIG, Inc., U.S.A. and licensed for use by RFMD. All other trade names, trademarks and registered trademarks are the property of their respective owners. ©2012, RF Micro Devices, Inc.

Absolute Maximum Ratings

Parameter	Rating	Unit
V_{D1}, V_{D2}, V_{D3}	+5.5	V
V_G	0	V
Junction Temperature		°C
Continuous P_{DISS} (T = 85 °C) (derate 37 mW/°C above T = 85 °C)		°C/W
Storage Temperature	-65 to +150	°C
Operating Temperature	-40 to +85	°C
ESD Sensitivity (HBM)		



Caution! ESD sensitive device.

Exceeding any one or a combination of the Absolute Maximum Rating conditions may cause permanent damage to the device. Extended application of Absolute Maximum Rating conditions to the device may reduce device reliability. Specified typical performance or functional operation of the device under Absolute Maximum Rating conditions is not implied.

The information in this publication is believed to be accurate and reliable. However, no responsibility is assumed by RF Micro Devices, Inc. ("RFMD") for its use, nor for any infringement of patents, or other rights of third parties, resulting from its use. No license is granted by implication or otherwise under any patent or patent rights of RFMD. RFMD reserves the right to change component circuitry, recommended application circuitry and specifications at any time without prior notice.



RFMD Green: RoHS compliant per EU Directive 2002/95/EC, halogen free per IEC 61249-2-21, < 1000ppm each of antimony trioxide in polymeric materials and red phosphorus as a flame retardant, and <2% antimony in solder.

Parameter	Specification			Unit	Condition
	Min.	Typ.	Max.		
Operational Frequency	17.7		19.7	GHz	
Positive Supply Voltage (V_{DD})		5.5		V	
Drain current (I_D)		1300		mA	
Small-signal Gain		23		dB	
Dynamic Range	12	15		dB	
P1dB		31		dBm	at 5V
OIP3		43		dBm	at $P_{OUT} = 20$ dBm (2 tones total power) in 17.7GHz to 19.7GHz frequency range
IM3		50		dBc	at $P_{OUT} = 20$ dBm (2 tones total power) in 17.7GHz to 19.7GHz frequency range
		40.6		dBc	at $P_{OUT} = 24$ dBm (2 tones total power) in 17.7GHz to 19.7GHz frequency range
		32.6		dBc	at $P_{OUT} = 27$ dBm (2 tones total power) in 17.7GHz to 19.7GHz frequency range
IM5		80		dBc	at $P_{OUT} = 20$ dBm (2 tones total power) in 17.7GHz to 19.7GHz frequency range
		66		dBc	at $P_{OUT} = 24$ dBm (2 tones total power) in 17.7GHz to 19.7GHz frequency range
Input Return Loss (RL_{IN})		12		dB	
Output Return Loss (RL_{OUT})		8		dB	
Noise Figure				dB	
ESD Sensitivity (HBM)				V	
ESD Sensitivity (MM)				V	
Moisture Sensitivity Level				V	

Small Signal Performance

$V_{D1} = V_{D2} = V_{D3} = 5.5V$, $I_{D1} + I_{D2} = 300mA$, $I_{D3} = 1000mA$, I_D (Total) = 1300mA

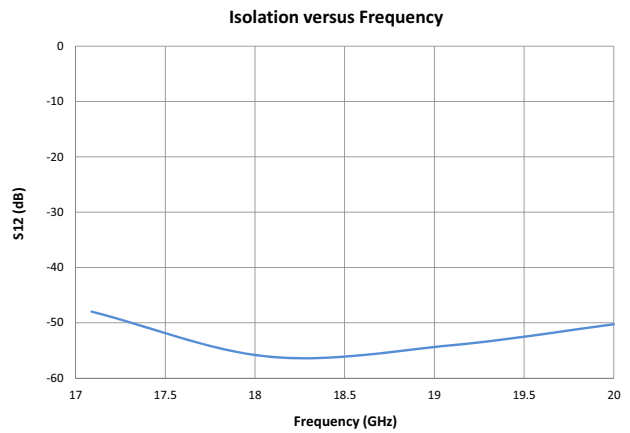
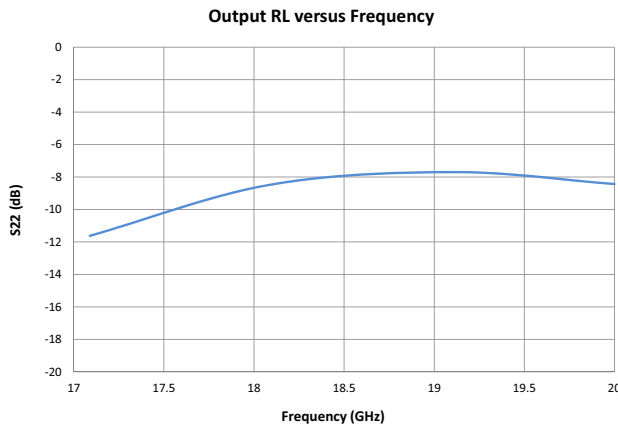
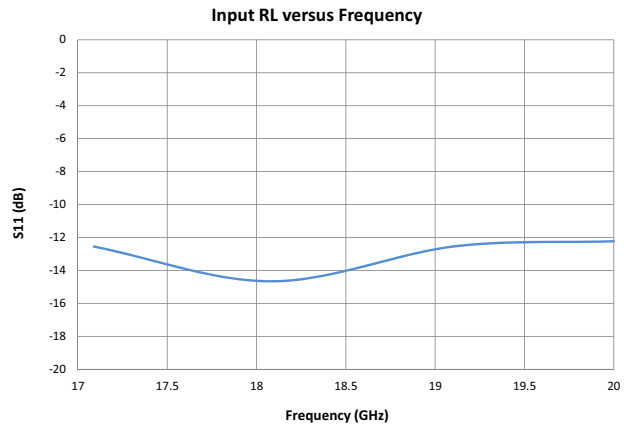
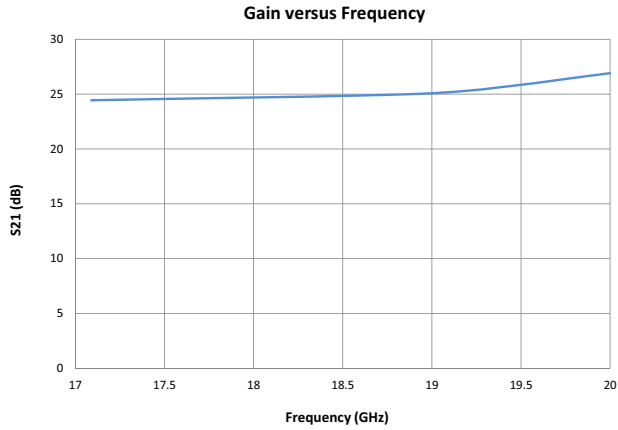

Typical Electrical Performance

$V_{D1} = V_{D2} = V_{D3} = 5.5V$, $I_{D1} + I_{D2} = 300mA$, $I_{D3} = 1000mA$, I_D (Total) = 1300mA

OIP3 versus Frequency

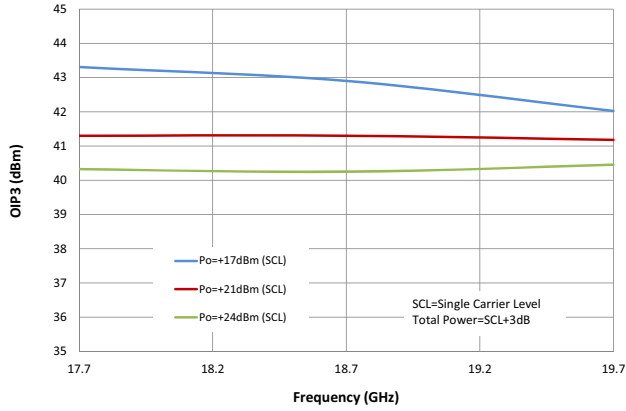

IM3 versus Frequency

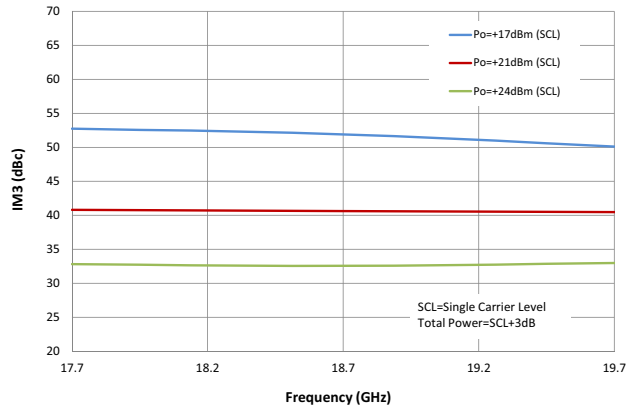

IM5 versus Frequency

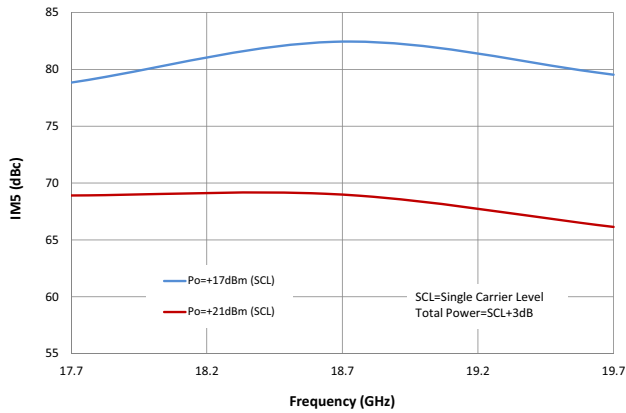

P₁dB and P₃dB versus Frequency (Vd=5V)

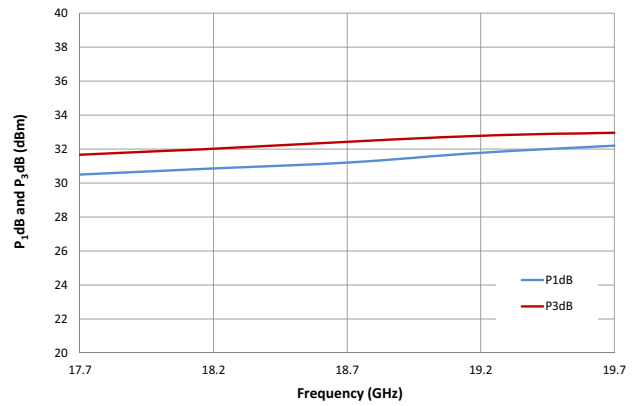

Gain and Pout versus Pin (Vd=5V and 18.7GHz)

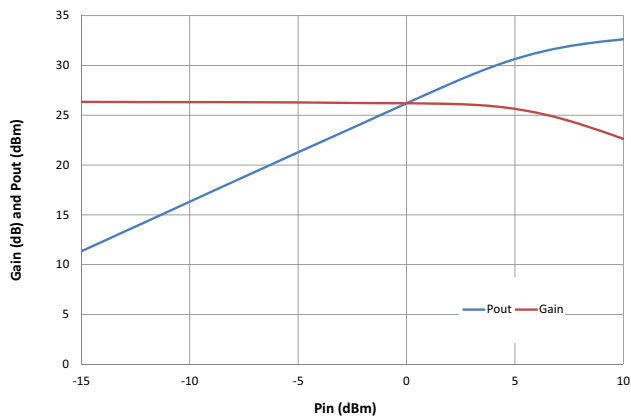

I_{ds} versus Pin (Vd=5V)

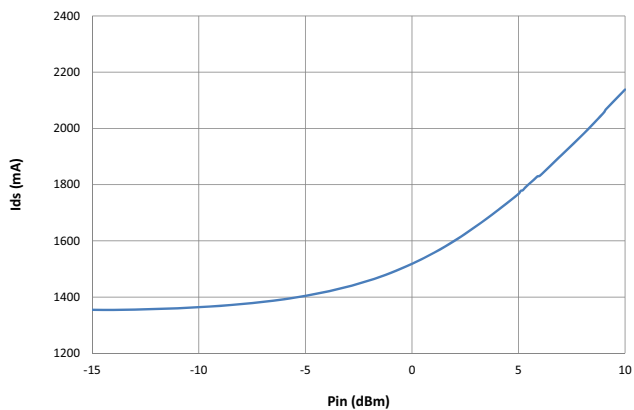

Typical Electrical Performance

$$V_{D1} = V_{D2} = V_{D3} = 5.5V$$

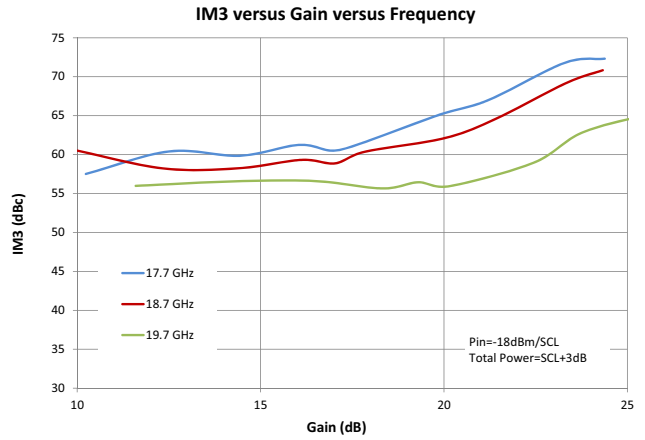
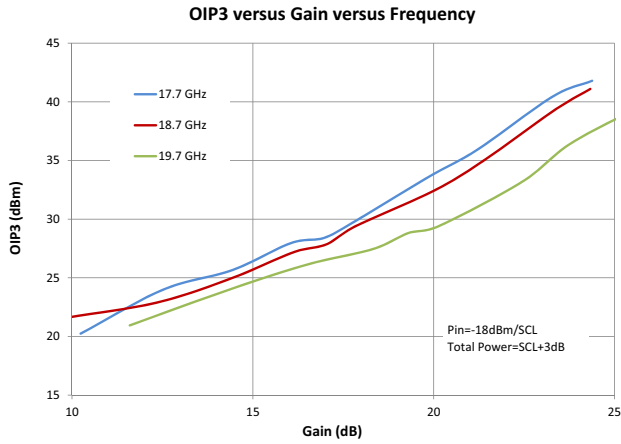
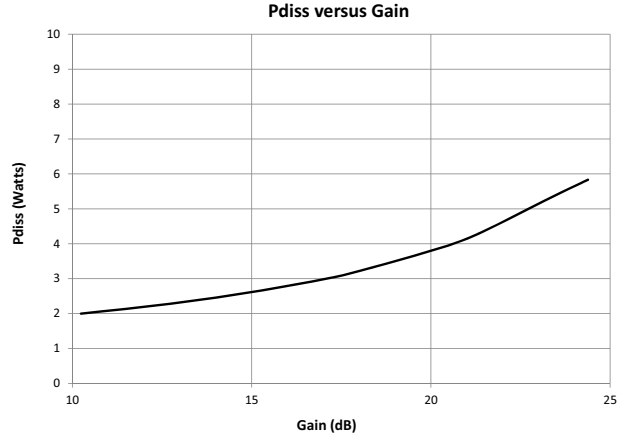
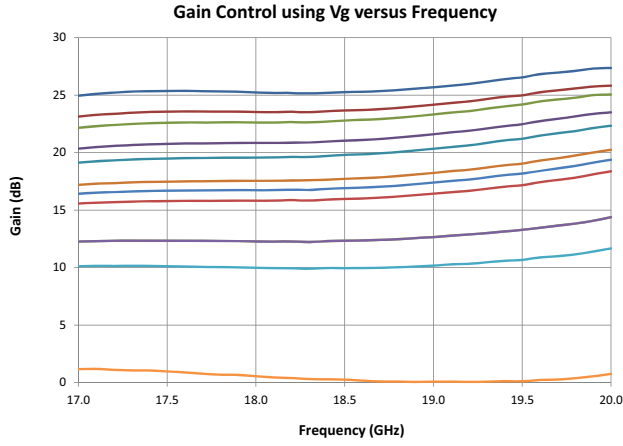

Pin Names and Descriptions

Pin	Name	Description
1	N/C	Not connected.
2	N/C	Not connected.
3	N/C	Not connected.
4	N/C	Not connected.
5	GND	Ground.
6	RFIN	RF input.
7	GND	Ground.
8	N/C	Not connected.
9	N/C	Not connected.
10	N/C	Not connected.
11	N/C	Not connected.
12	N/C	Not connected.
13	VG1	Gate bias 1.
14	VD1	Drain bias 1.
15	VG2	Gate bias 2.
16	VD2	Drain bias 2.
17	VG3	Gate bias 3.
18	N/C	Not connected.
19	VD3B	Drain bias 3.
20	N/C	Not connected.
21	N/C	Not connected.
22	N/C	Not connected.
23	N/C	Not connected.
24	GND	Ground.
25	RFOUT	RF output.
26	GND	Ground.
27	N/C	Not connected.
28	N/C	Not connected.
29	DET	Detector Out.
30	REF	Detector Reference.
31	N/C	Not connected.
32	VD3A	Drain bias 3.
33	N/C	Not connected.
34	VG3	Gate bias 3.
35	VD2	Drain bias 2.
36	VG2	Gate bias 2.
37	VD1	Drain bias 1.
38	VG1	Gate bias 1.
39	N/C	Not connected.
40	N/C	Not connected.

Pin Out

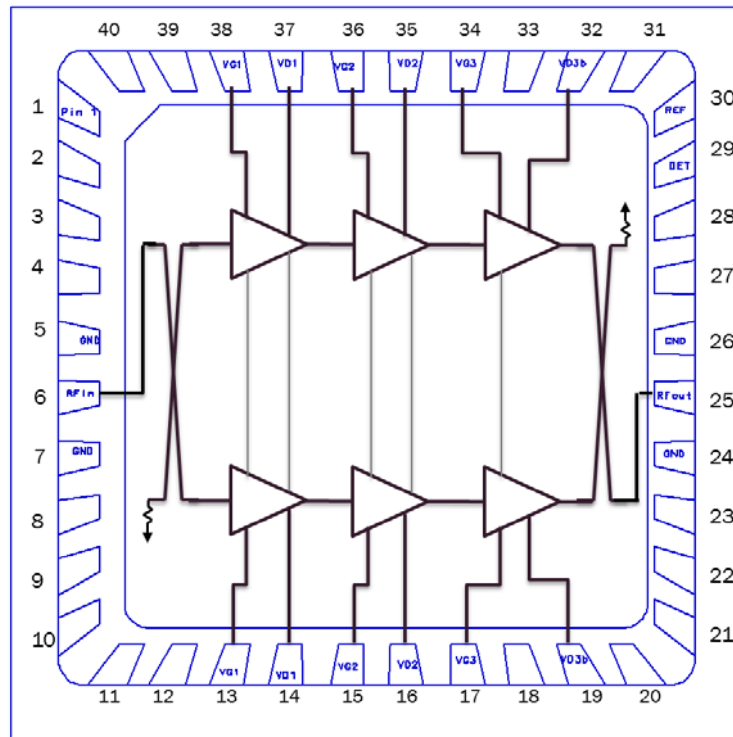

Package Drawing

QFN, 32-Pin, 6mm x 6mm x 0.95mm

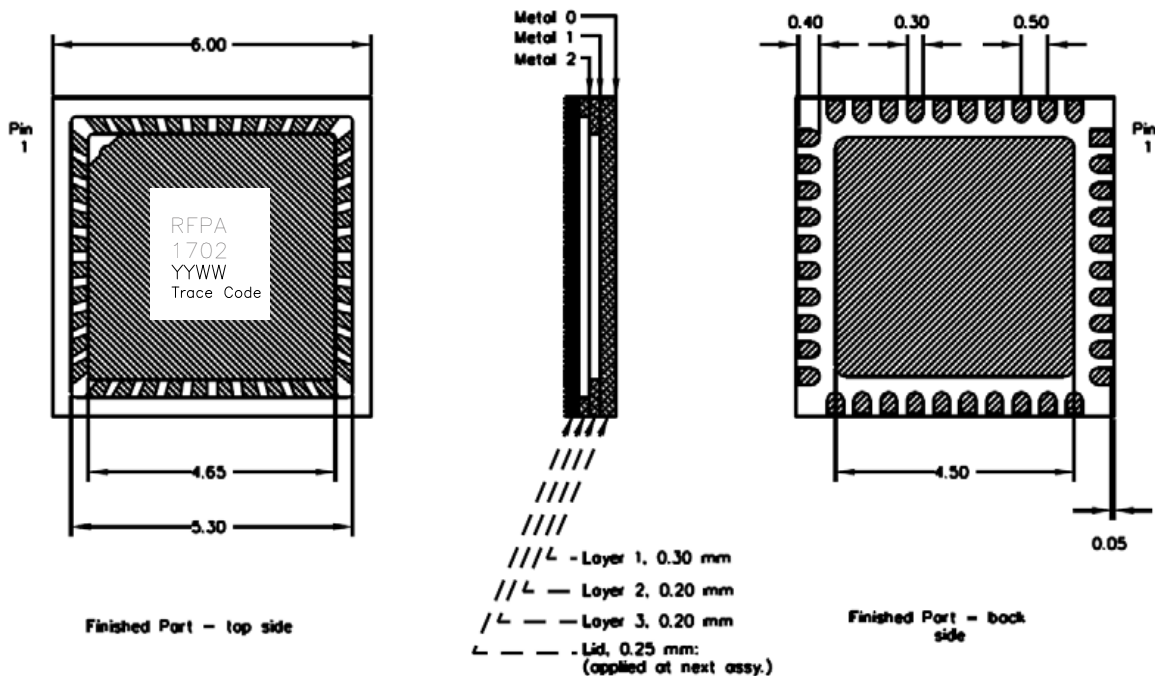

Sample Application Circuit Schematic

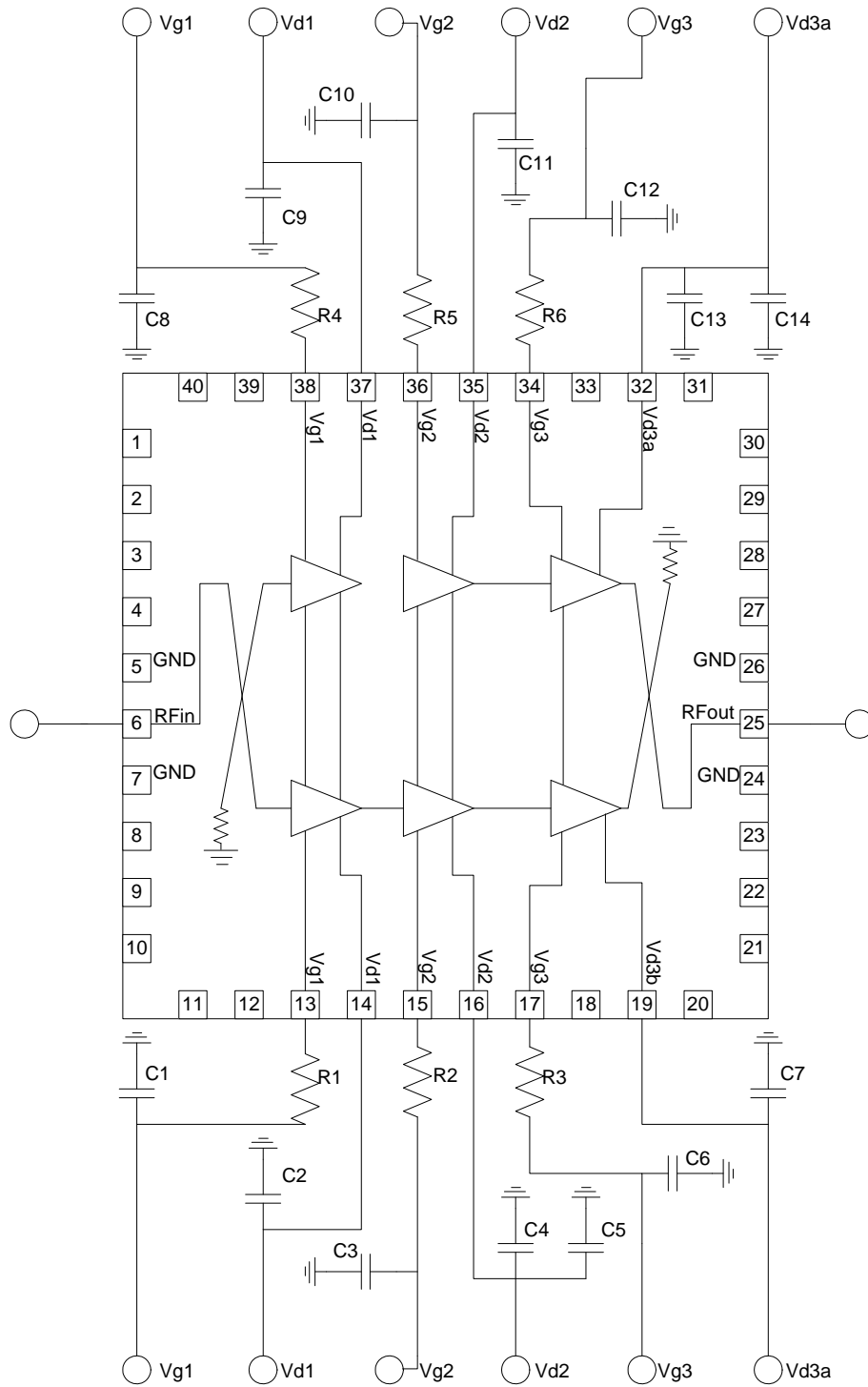

Evaluation Board Layout

