

BC846BPDW1, BC847BPDW1, BC848CPDW1 Series



ON Semiconductor®

<http://onsemi.com>

Dual General Purpose Transistors

NPN/PNP Duals (Complementary)

These transistors are designed for general purpose amplifier applications. They are housed in the SOT-363/SC-88 which is designed for low power surface mount applications.

Features

- S Prefix for Automotive and Other Applications Requiring Unique Site and Control Change Requirements; AEC-Q101 Qualified and PPAP Capable
- These Devices are Pb-Free, Halogen Free/BFR Free and are RoHS Compliant*

MAXIMUM RATINGS – NPN

Rating	Symbol	Value	Unit
Collector-Emitter Voltage BC846, SBC846 BC847, SBC847 BC848	V_{CEO}	65 45 30	V
Collector-Base Voltage BC846, SBC846 BC847, SBC847 BC848	V_{CBO}	80 50 30	V
Emitter-Base Voltage	V_{EBO}	6.0	V
Collector Current – Continuous	I_C	100	mAdc

MAXIMUM RATINGS – PNP

Rating	Symbol	Value	Unit
Collector-Emitter Voltage BC846, SBC846 BC847, SBC847 BC848	V_{CEO}	-65 -45 -30	V
Collector-Base Voltage BC846, SBC846 BC847, SBC847 BC848	V_{CBO}	-80 -50 -30	V
Emitter-Base Voltage	V_{EBO}	-5.0	V
Collector Current – Continuous	I_C	-100	mAdc

Stresses exceeding Maximum Ratings may damage the device. Maximum Ratings are stress ratings only. Functional operation above the Recommended Operating Conditions is not implied. Extended exposure to stresses above the Recommended Operating Conditions may affect device reliability.

*For additional information on our Pb-Free strategy and soldering details, please download the ON Semiconductor Soldering and Mounting Techniques Reference Manual, SOLDERRM/D.



SOT-363
CASE 419B
STYLE 1

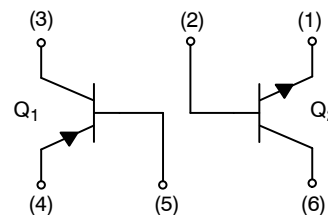

MARKING DIAGRAM

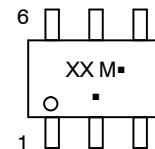

XX = Device Code
M = Date Code
▪ = Pb-Free Package

(Note: Microdot may be in either location)

ORDERING INFORMATION

Device	Mark	Package	Shipping†
BC846BPDW1T1G, SBC846BPDW1T1G	BB	SOT-363 (Pb-Free)	3,000 / Tape & Reel
SBC846BPDW1T2G	BB	SOT-363 (Pb-Free)	3,000 / Tape & Reel
BC847BPDW1T1G	BF	SOT-363 (Pb-Free)	3,000 / Tape & Reel
SBC847BPDW1T1G	BF	SOT-363 (Pb-Free)	3,000 / Tape & Reel
SBC847BPDW1T3G	BF	SOT-363 (Pb-Free)	10,000 / Tape & Reel
BC847BPDW1T2G	BF	SOT-363 (Pb-Free)	3,000 / Tape & Reel
BC848CPDW1T1G	BL	SOT-363 (Pb-Free)	3,000 / Tape & Reel

†For information on tape and reel specifications, including part orientation and tape sizes, please refer to our Tape and Reel Packaging Specification Brochure, BRD8011/D.

BC846BPDW1, BC847BPDW1, BC848CPDW1 Series

THERMAL CHARACTERISTICS

Characteristic	Symbol	Max	Unit
Total Device Dissipation Per Device FR-5 Board (Note 1) $T_A = 25^\circ\text{C}$ Derate above 25°C	P_D	380 250 3.0	mW mW/ $^\circ\text{C}$ mW/ $^\circ\text{C}$
Thermal Resistance, Junction-to-Ambient	$R_{\theta JA}$	328	$^\circ\text{C/W}$
Junction and Storage Temperature	T_J, T_{stg}	-55 to +150	$^\circ\text{C}$

1. FR-5 = 1.0 x 0.75 x 0.062 in.

ELECTRICAL CHARACTERISTICS (NPN) ($T_A = 25^\circ\text{C}$ unless otherwise noted)

Characteristic	Symbol	Min	Typ	Max	Unit
----------------	--------	-----	-----	-----	------

OFF CHARACTERISTICS

Collector - Emitter Breakdown Voltage ($I_C = 10\text{ mA}$) BC846, SBC846 Series BC847, SBC847 Series BC848 Series	$V_{(BR)CEO}$	65 45 30	- - -	- - -	V
Collector - Emitter Breakdown Voltage ($I_C = 10\ \mu\text{A}, V_{EB} = 0$) BC846, SBC846 Series BC847B, SBC847B Only BC848 Series	$V_{(BR)CES}$	80 50 30	- - -	- - -	V
Collector - Base Breakdown Voltage ($I_C = 10\ \mu\text{A}$) BC846, SBC846 Series BC847, SBC847 Series BC848 Series	$V_{(BR)CBO}$	80 50 30	- - -	- - -	V
Emitter - Base Breakdown Voltage ($I_E = 1.0\ \mu\text{A}$) BC846, SBC846 Series BC847, SBC847 Series BC848 Series	$V_{(BR)EBO}$	6.0 6.0 5.0	- - -	- - -	V
Collector Cutoff Current ($V_{CB} = 30\text{ V}$) ($V_{CB} = 30\text{ V}, T_A = 150^\circ\text{C}$)	I_{CBO}	- -	- -	15 5.0	nA μA

ON CHARACTERISTICS

DC Current Gain ($I_C = 10\ \mu\text{A}, V_{CE} = 5.0\text{ V}$) BC846B, SBC846B, BC847B, SBC847B BC848C ($I_C = 2.0\text{ mA}, V_{CE} = 5.0\text{ V}$) BC846B, SBC846B, BC847B, SBC847B BC848C	h_{FE}	- - 200 420	150 270 290 520	- - 475 800	-
Collector - Emitter Saturation Voltage ($I_C = 10\text{ mA}, I_B = 0.5\text{ mA}$) ($I_C = 100\text{ mA}, I_B = 5.0\text{ mA}$)	$V_{CE(sat)}$	- -	- -	0.25 0.6	V
Base - Emitter Saturation Voltage ($I_C = 10\text{ mA}, I_B = 0.5\text{ mA}$) ($I_C = 100\text{ mA}, I_B = 5.0\text{ mA}$)	$V_{BE(sat)}$	- -	0.7 0.9	- -	V
Base - Emitter Voltage ($I_C = 2.0\text{ mA}, V_{CE} = 5.0\text{ V}$) ($I_C = 10\text{ mA}, V_{CE} = 5.0\text{ V}$)	$V_{BE(on)}$	580 -	660 -	700 770	mV

SMALL-SIGNAL CHARACTERISTICS

Current - Gain - Bandwidth Product ($I_C = 10\text{ mA}, V_{CE} = 5.0\text{ Vdc}, f = 100\text{ MHz}$)	f_T	100	-	-	MHz
Output Capacitance ($V_{CB} = 10\text{ V}, f = 1.0\text{ MHz}$)	C_{obo}	-	-	4.5	pF
Noise Figure ($I_C = 0.2\text{ mA}, V_{CE} = 5.0\text{ Vdc}, R_S = 2.0\text{ k}\Omega, f = 1.0\text{ kHz}, BW = 200\text{ Hz}$)	NF	-	-	10	dB

BC846BPDW1, BC847BPDW1, BC848CPDW1 Series

ELECTRICAL CHARACTERISTICS (PNP) ($T_A = 25^\circ\text{C}$ unless otherwise noted)

Characteristic	Symbol	Min	Typ	Max	Unit
OFF CHARACTERISTICS					
Collector – Emitter Breakdown Voltage ($I_C = -10\text{ mA}$) BC846, SBC846 Series BC847, SBC847 Series BC848 Series	$V_{(BR)CEO}$	-65 -45 -30	-	-	V
Collector – Emitter Breakdown Voltage ($I_C = -10\text{ }\mu\text{A}$, $V_{EB} = 0$) BC846, SBC846 Series BC847, SBC847 Series BC848 Series	$V_{(BR)CES}$	-80 -50 -30	-	-	V
Collector – Base Breakdown Voltage ($I_C = -10\text{ }\mu\text{A}$) BC846, SBC846 Series BC847, SBC847 Series BC848 Series	$V_{(BR)CBO}$	-80 -50 -30	-	-	V
Emitter – Base Breakdown Voltage ($I_E = -1.0\text{ }\mu\text{A}$) BC846, SBC846 Series BC847, SBC847 Series BC848 Series	$V_{(BR)EBO}$	-5.0 -5.0 -5.0	-	-	V
Collector Cutoff Current ($V_{CB} = -30\text{ V}$) ($V_{CB} = -30\text{ V}$, $T_A = 150^\circ\text{C}$)	I_{CBO}	-	-	-15 -4.0	nA μA
ON CHARACTERISTICS					
DC Current Gain ($I_C = -10\text{ }\mu\text{A}$, $V_{CE} = -5.0\text{ V}$) BC846B, SBC846B, BC847B, SBC847B BC848C ($I_C = -2.0\text{ mA}$, $V_{CE} = -5.0\text{ V}$) BC846B, SBC846B, BC847B, SBC847B BC848C	h_{FE}	- - 200 420	150 270 290 520	- - 475 800	-
Collector – Emitter Saturation Voltage ($I_C = -10\text{ mA}$, $I_B = -0.5\text{ mA}$) ($I_C = -100\text{ mA}$, $I_B = -5.0\text{ mA}$)	$V_{CE(sat)}$	- -	- -	-0.3 -0.65	V
Base – Emitter Saturation Voltage ($I_C = -10\text{ mA}$, $I_B = -0.5\text{ mA}$) ($I_C = -100\text{ mA}$, $I_B = -5.0\text{ mA}$)	$V_{BE(sat)}$	- -	-0.7 -0.9	- -	V
Base – Emitter On Voltage ($I_C = -2.0\text{ mA}$, $V_{CE} = -5.0\text{ V}$) ($I_C = -10\text{ mA}$, $V_{CE} = -5.0\text{ V}$)	$V_{BE(on)}$	-0.6 -	- -	-0.75 -0.82	V
SMALL-SIGNAL CHARACTERISTICS					
Current – Gain – Bandwidth Product ($I_C = -10\text{ mA}$, $V_{CE} = -5.0\text{ Vdc}$, $f = 100\text{ MHz}$)	f_T	100	-	-	MHz
Output Capacitance ($V_{CB} = -10\text{ V}$, $f = 1.0\text{ MHz}$)	C_{ob}	-	-	4.5	pF
Noise Figure ($I_C = -0.2\text{ mA}$, $V_{CE} = -5.0\text{ Vdc}$, $R_S = 2.0\text{ k}\Omega$, $f = 1.0\text{ kHz}$, $BW = 200\text{ Hz}$)	NF	-	-	10	dB

BC846BPDW1, BC847BPDW1, BC848CPDW1 Series

TYPICAL NPN CHARACTERISTICS – BC846/SBC846

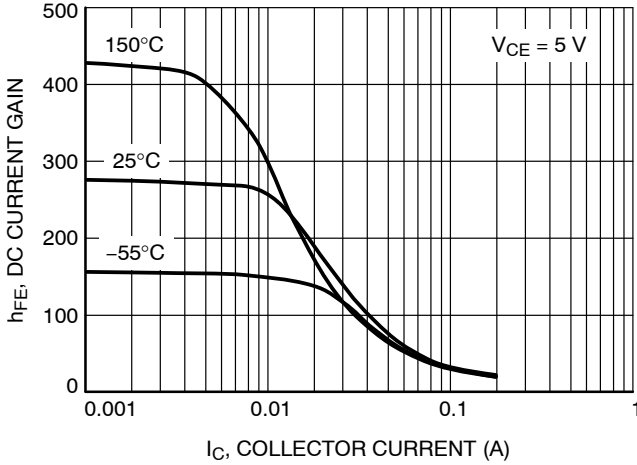

Figure 1. DC Current Gain vs. Collector Current

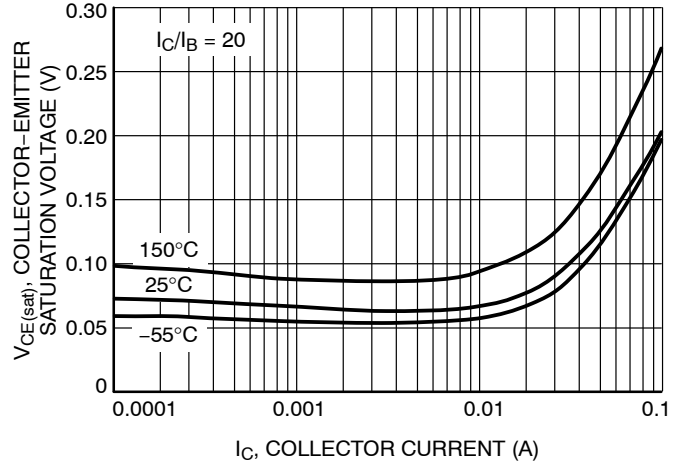

Figure 2. Collector Emitter Saturation Voltage vs. Collector Current

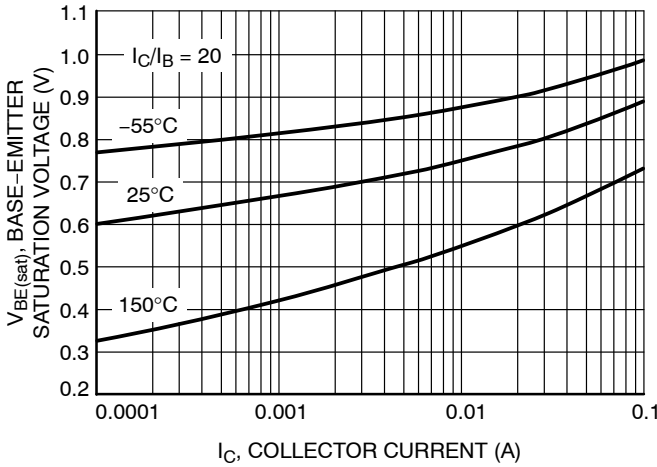

Figure 3. Base Emitter Saturation Voltage vs. Collector Current

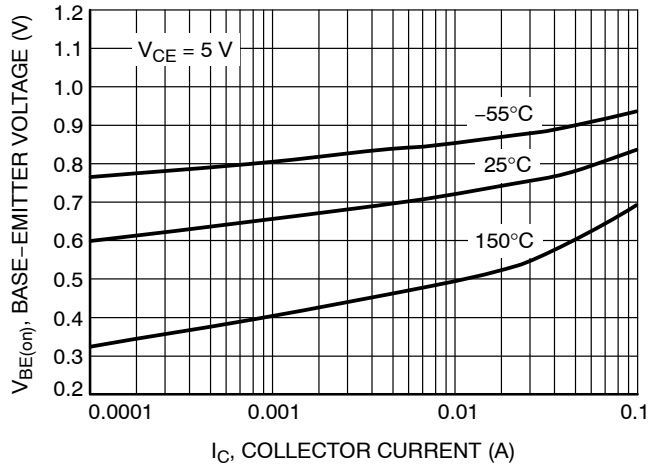

Figure 4. Base Emitter Voltage vs. Collector Current

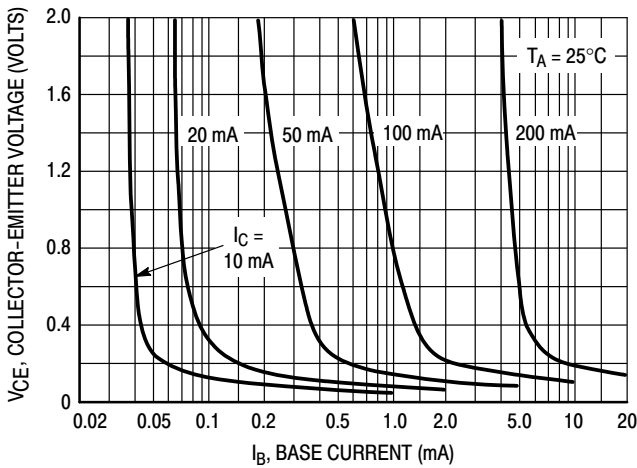

Figure 5. Collector Saturation Region

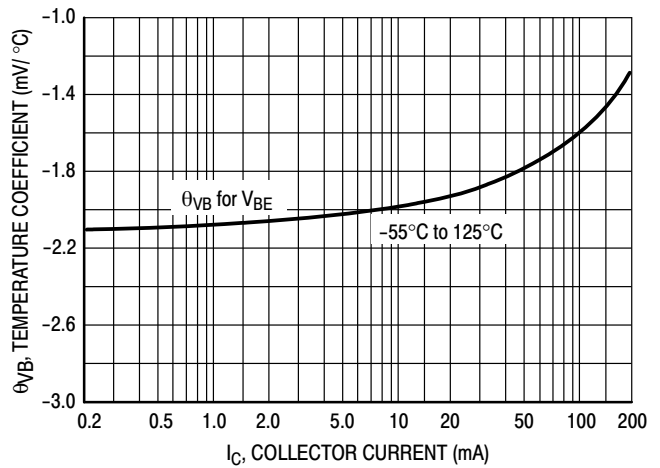

Figure 6. Base-Emitter Temperature Coefficient

BC846BPDW1, BC847BPDW1, BC848CPDW1 Series

TYPICAL NPN CHARACTERISTICS – BC846/SBC846

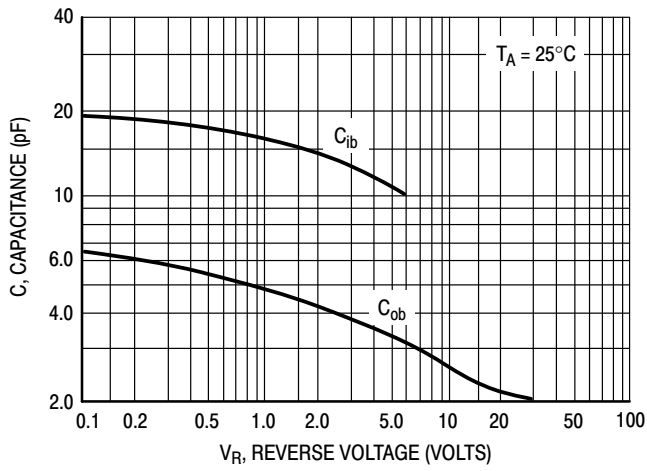

Figure 7. Capacitance

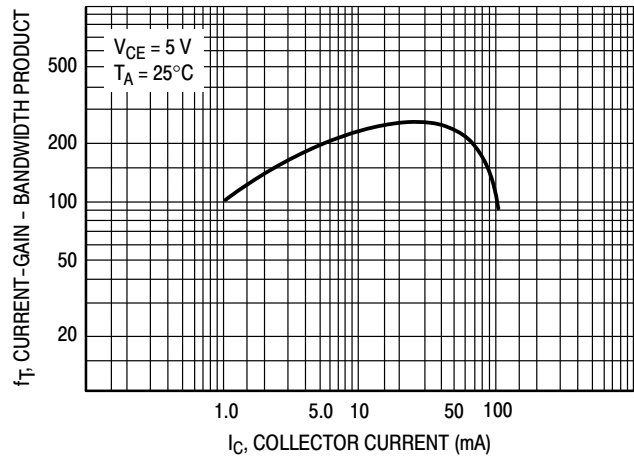

Figure 8. Current-Gain - Bandwidth Product

BC846BPDW1, BC847BPDW1, BC848CPDW1 Series

TYPICAL PNP CHARACTERISTICS — BC846/SBC846

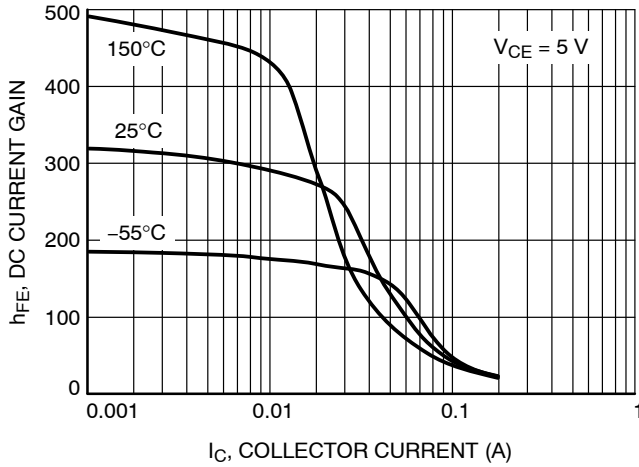

Figure 9. DC Current Gain vs. Collector Current

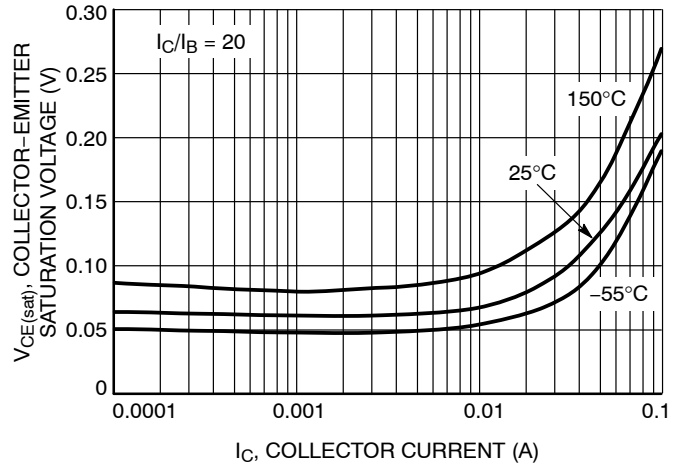

Figure 10. Collector Emitter Saturation Voltage vs. Collector Current

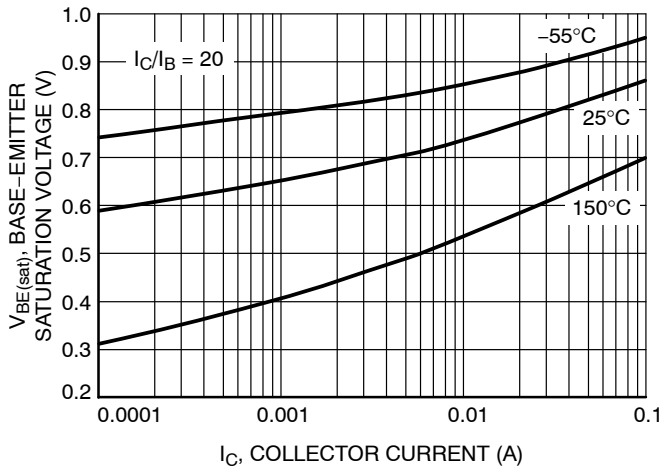

Figure 11. Base Emitter Saturation Voltage vs. Collector Current

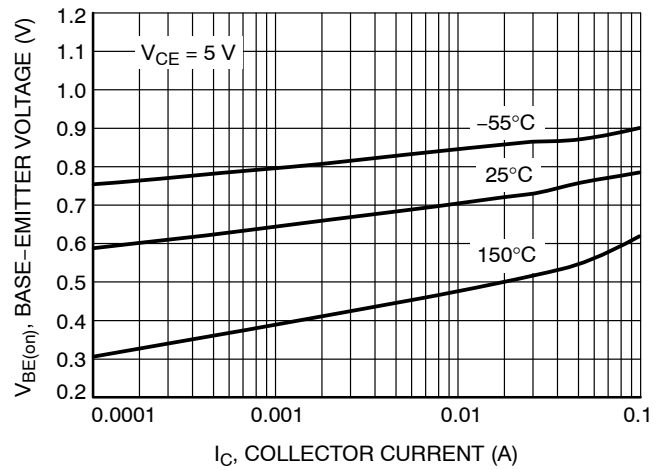

Figure 12. Base Emitter Voltage vs. Collector Current

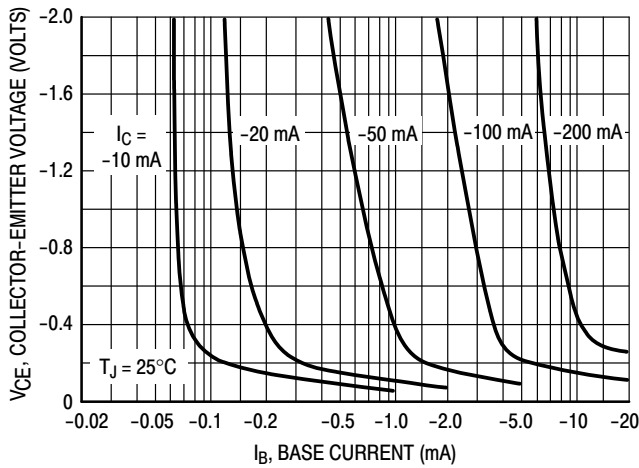

Figure 13. Collector Saturation Region

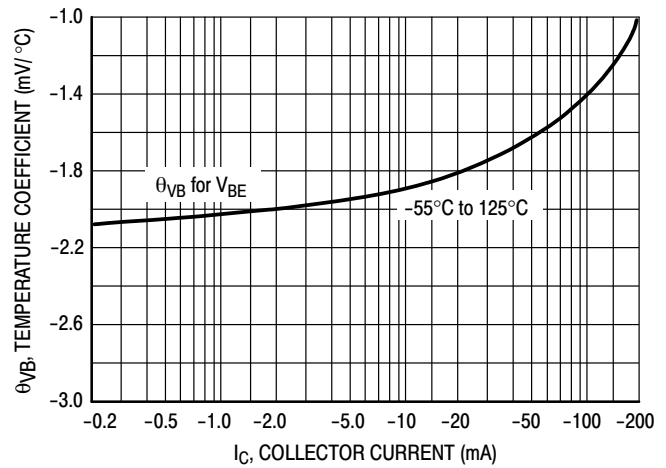

Figure 14. Base-Emitter Temperature Coefficient

BC846BPDW1, BC847BPDW1, BC848CPDW1 Series

TYPICAL PNP CHARACTERISTICS — BC846/SBC846



Figure 15. Capacitance

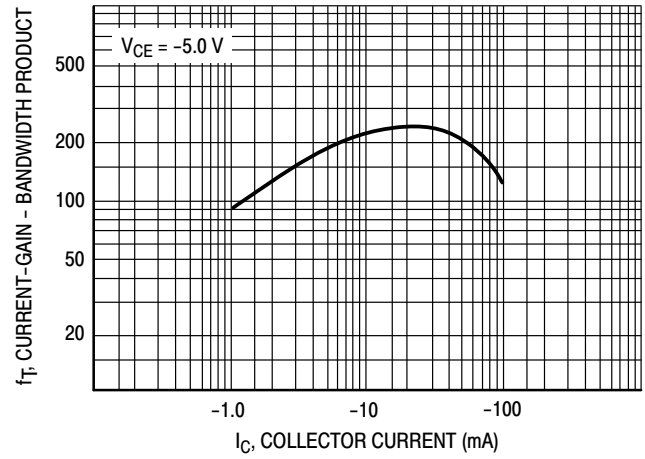

Figure 16. Current-Gain - Bandwidth Product

BC846BPDW1, BC847BPDW1, BC848CPDW1 Series

TYPICAL NPN CHARACTERISTICS – BC847/SBC847 SERIES

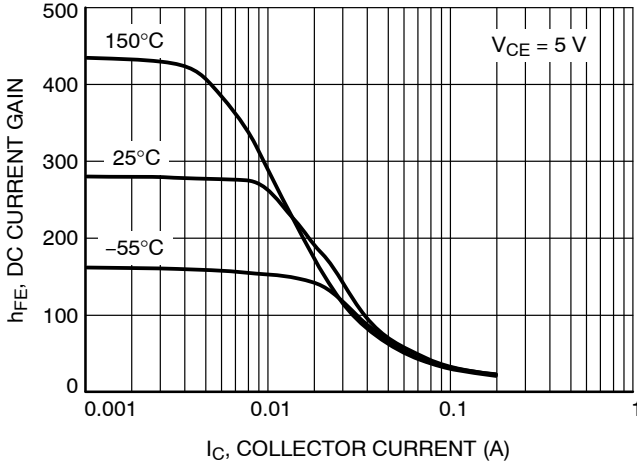

Figure 17. DC Current Gain vs. Collector Current

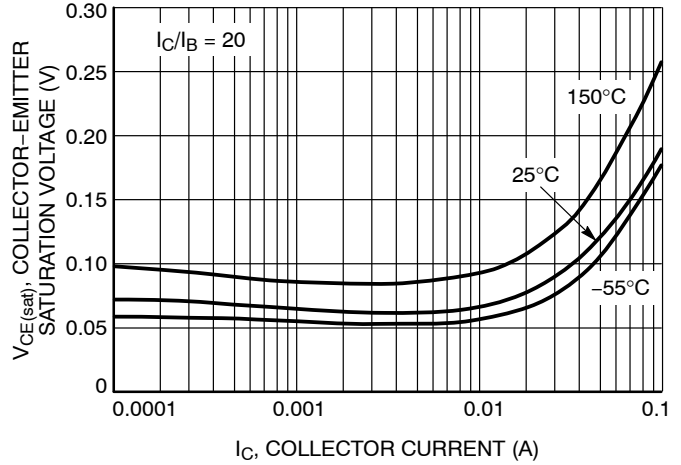

Figure 18. Collector Emitter Saturation Voltage vs. Collector Current

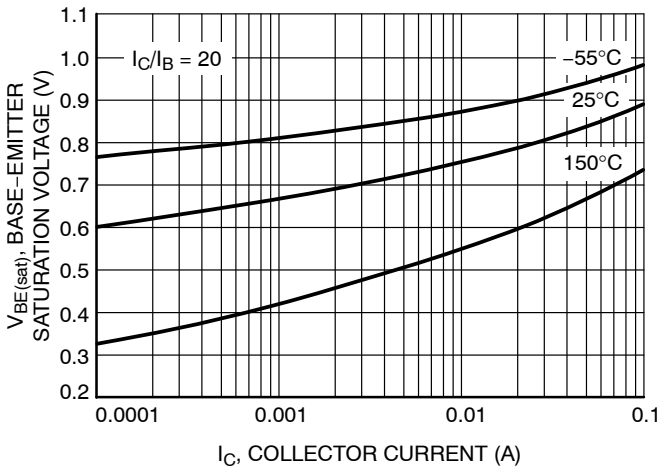

Figure 19. Base Emitter Saturation Voltage vs. Collector Current

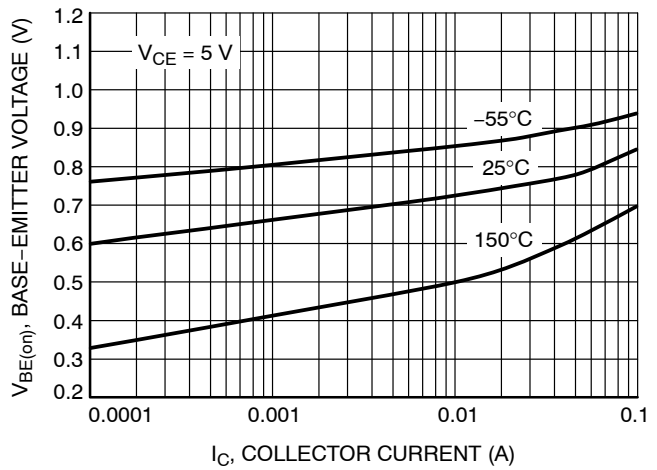

Figure 20. Base Emitter Voltage vs. Collector Current

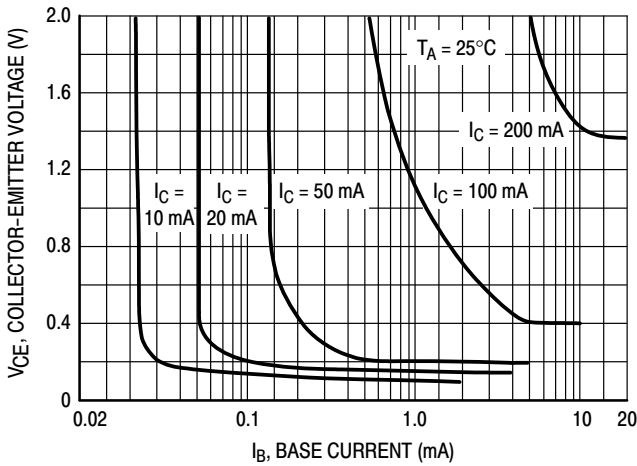

Figure 21. Collector Saturation Region

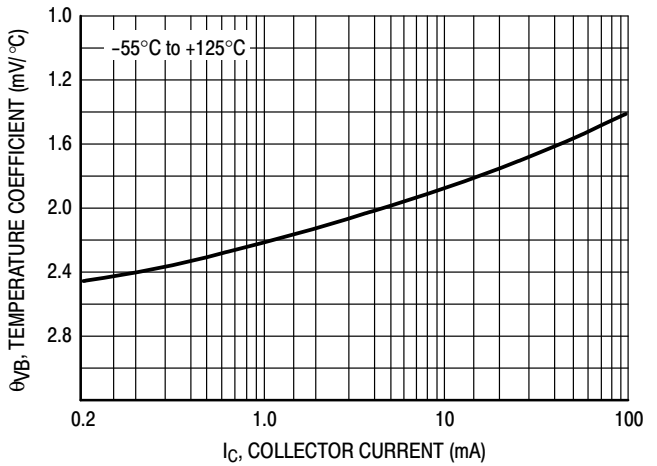

Figure 22. Base-Emitter Temperature Coefficient

BC846BPDW1, BC847BPDW1, BC848CPDW1 Series

TYPICAL NPN CHARACTERISTICS – BC847/SBC847 SERIES

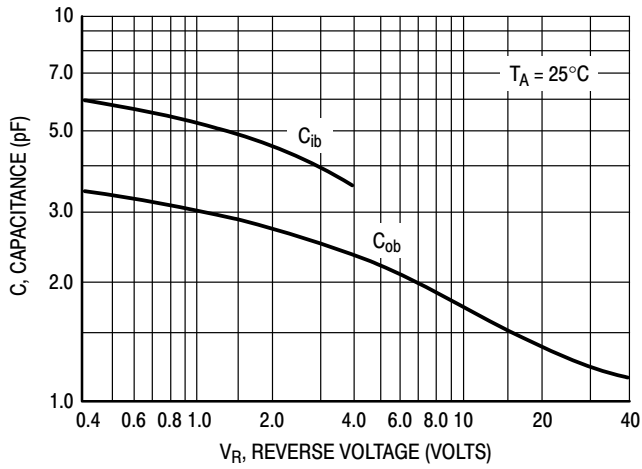

Figure 23. Capacitances



Figure 24. Current-Gain - Bandwidth Product

BC846BPDW1, BC847BPDW1, BC848CPDW1 Series

TYPICAL PNP CHARACTERISTICS – BC847/SBC847 SERIES

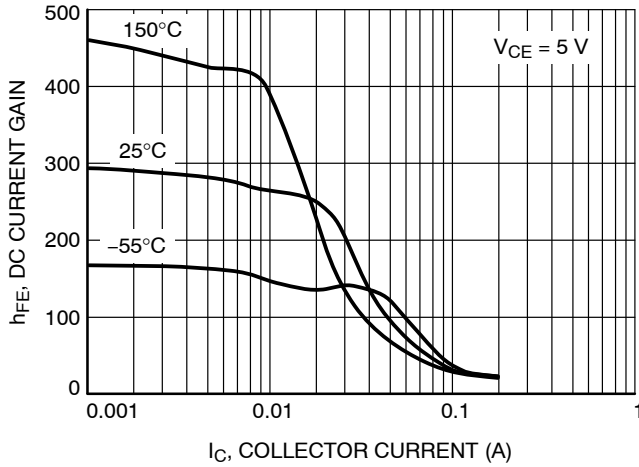

Figure 25. DC Current Gain vs. Collector Current

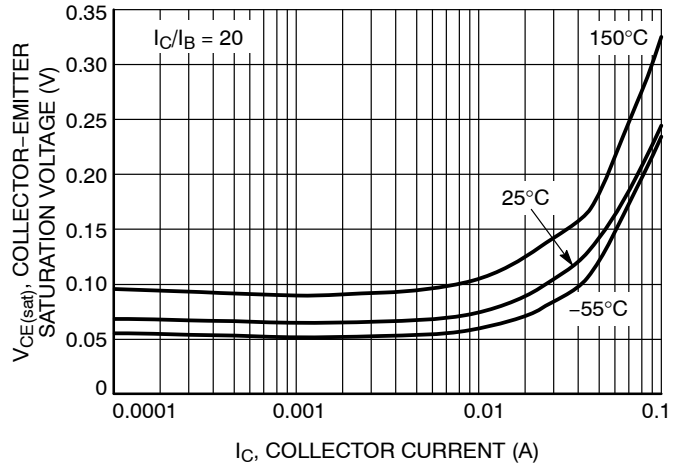

Figure 26. Collector Emitter Saturation Voltage vs. Collector Current

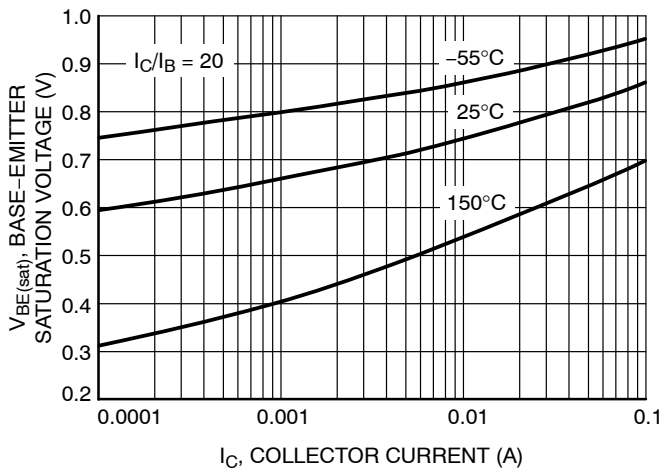

Figure 27. Base Emitter Saturation Voltage vs. Collector Current

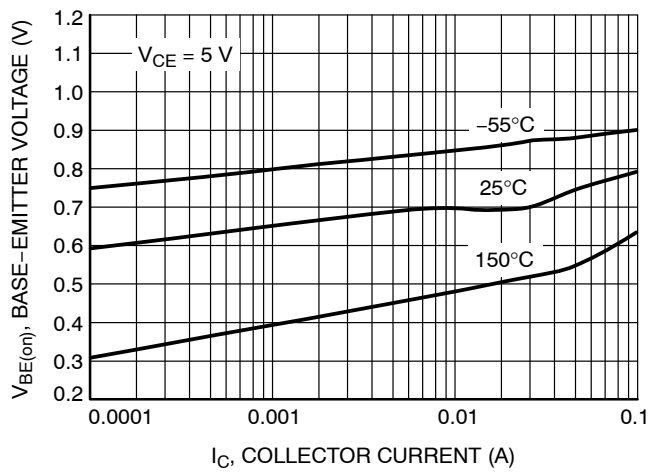

Figure 28. Base Emitter Voltage vs. Collector Current

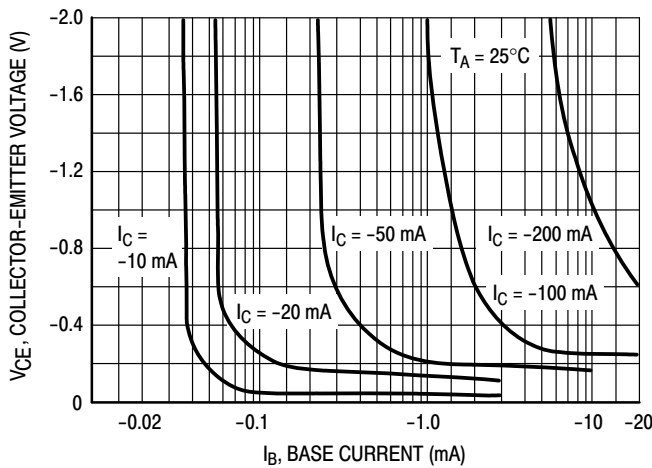

Figure 29. Collector Saturation Region

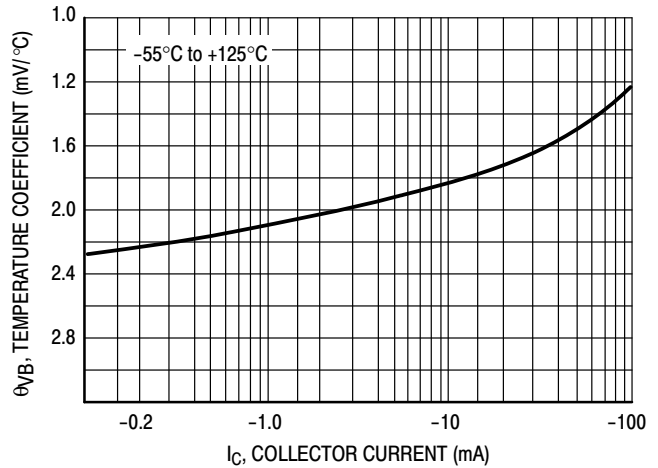

Figure 30. Base-Emitter Temperature Coefficient

BC846BPDW1, BC847BPDW1, BC848CPDW1 Series

TYPICAL PNP CHARACTERISTICS – BC847/SBC847 SERIES

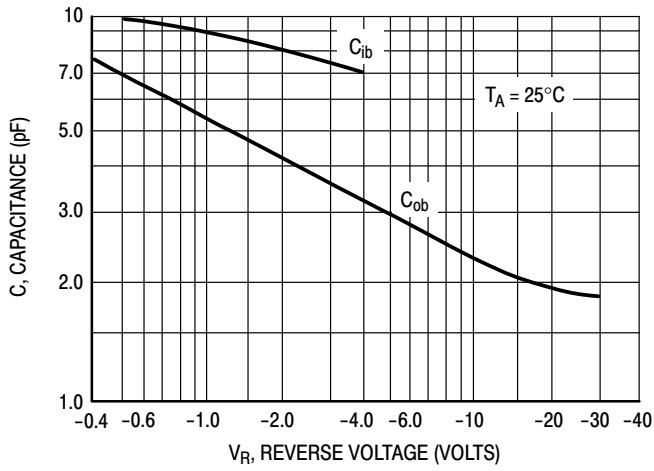

Figure 31. Capacitances

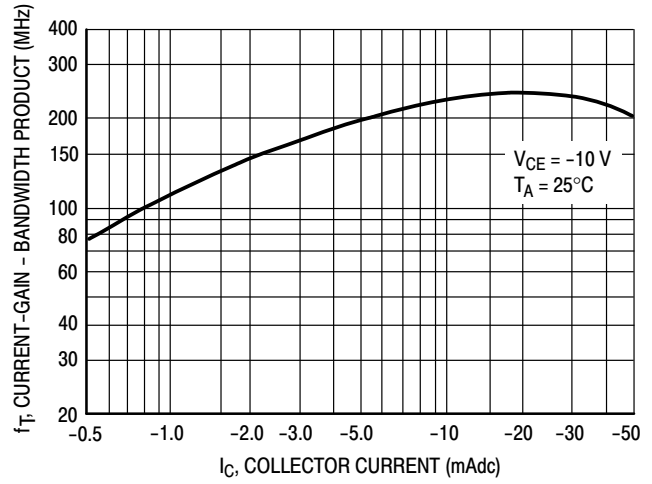

Figure 32. Current-Gain - Bandwidth Product

BC846BPDW1, BC847BPDW1, BC848CPDW1 Series

TYPICAL NPN CHARACTERISTICS – BC848 SERIES

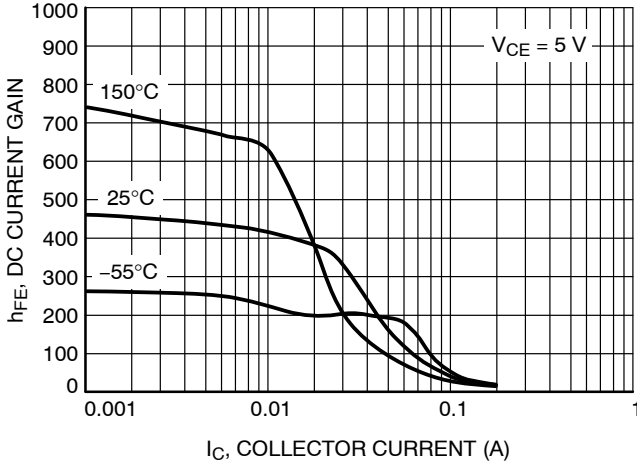

Figure 33. DC Current Gain vs. Collector Current

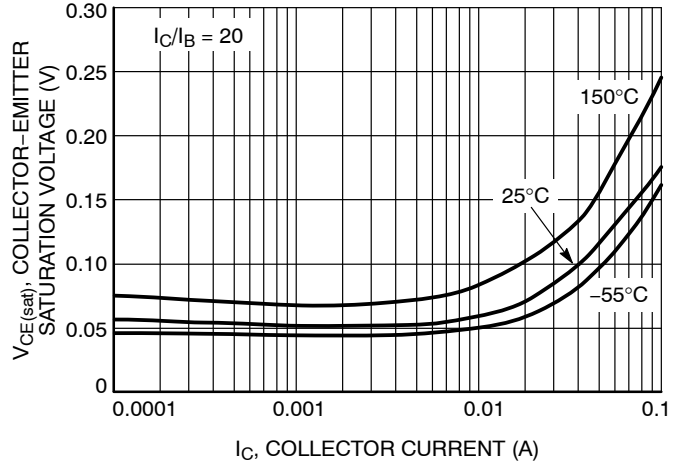

Figure 34. Collector Emitter Saturation Voltage vs. Collector Current

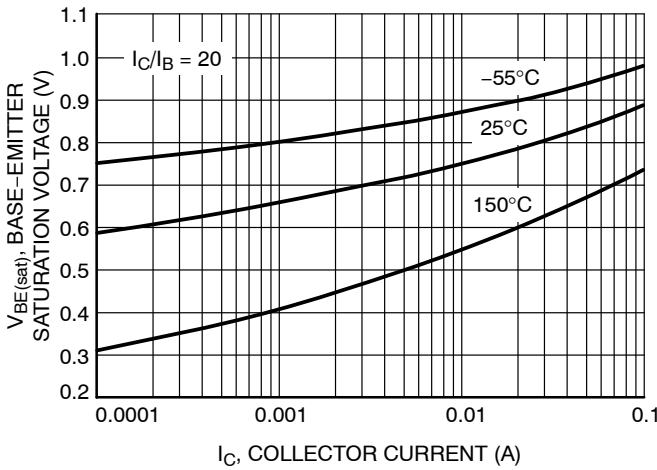

Figure 35. Base Emitter Saturation Voltage vs. Collector Current

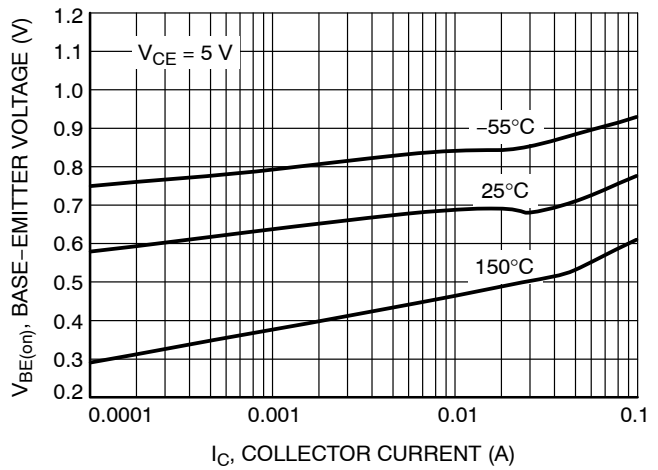

Figure 36. Base Emitter Voltage vs. Collector Current

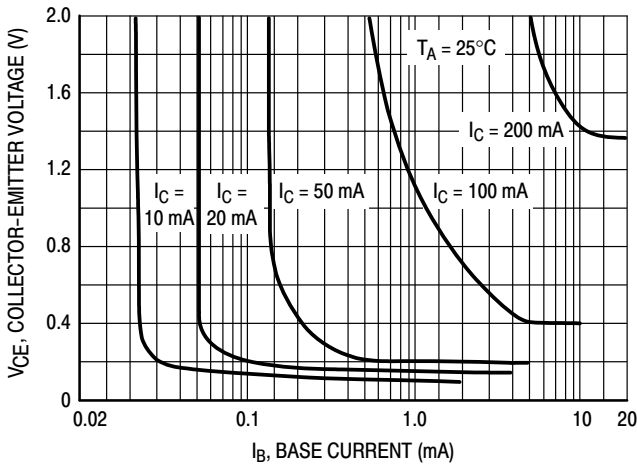

Figure 37. Collector Saturation Region

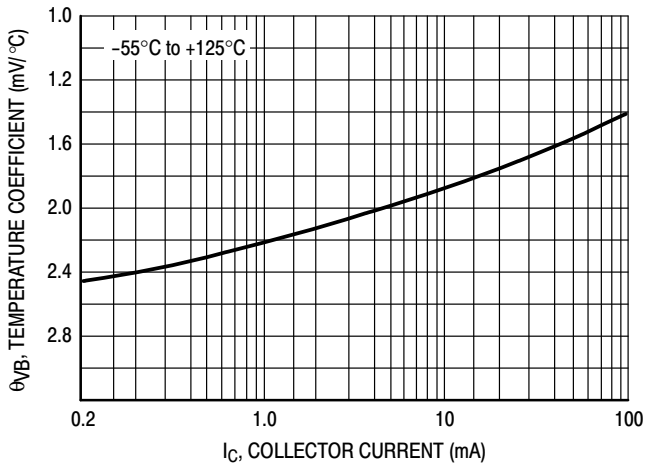

Figure 38. Base-Emitter Temperature Coefficient

BC846BPDW1, BC847BPDW1, BC848CPDW1 Series

TYPICAL NPN CHARACTERISTICS – BC848 SERIES

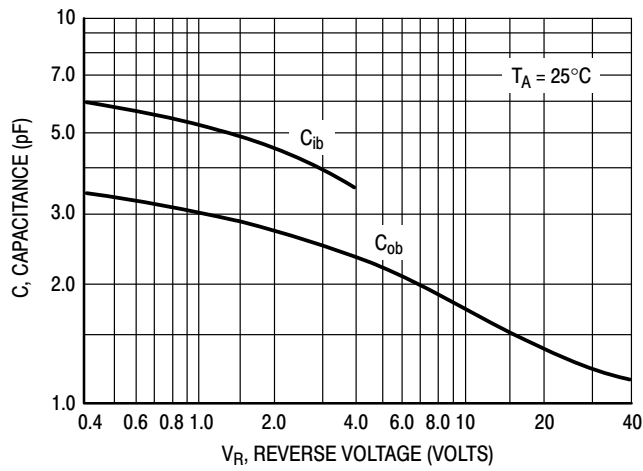

Figure 39. Capacitances

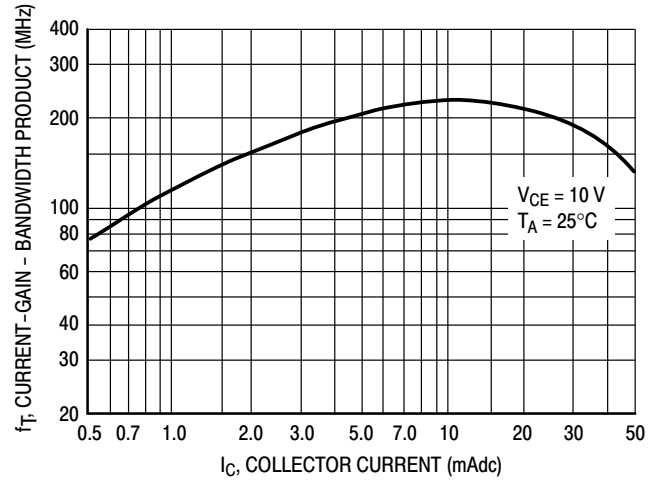

Figure 40. Current-Gain - Bandwidth Product

BC846BPDW1, BC847BPDW1, BC848CPDW1 Series

TYPICAL PNP CHARACTERISTICS – BC848 SERIES

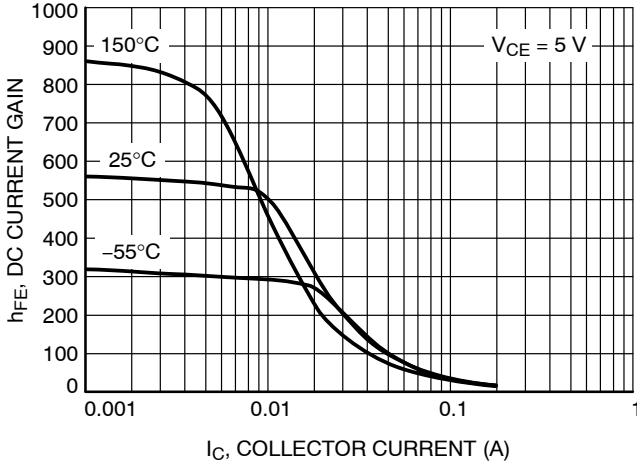

Figure 41. DC Current Gain vs. Collector Current

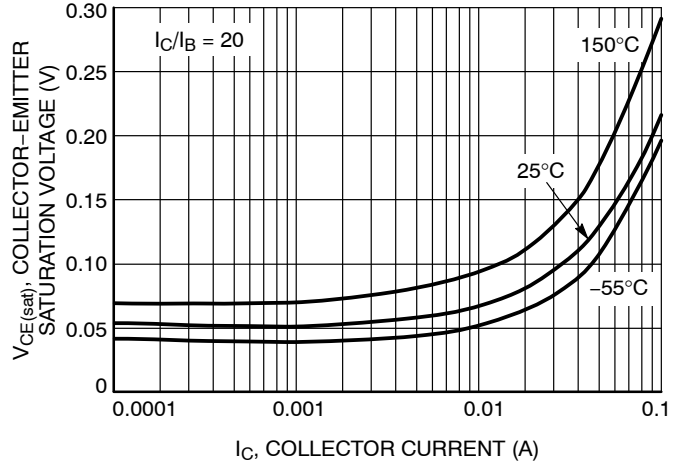

Figure 42. Collector Emitter Saturation Voltage vs. Collector Current

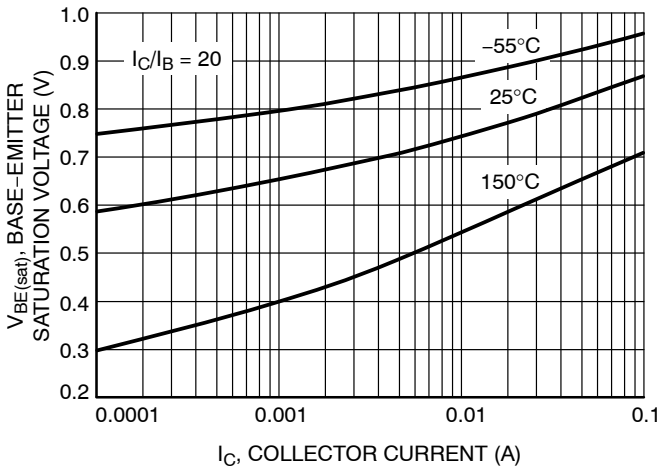

Figure 43. Base Emitter Saturation Voltage vs. Collector Current

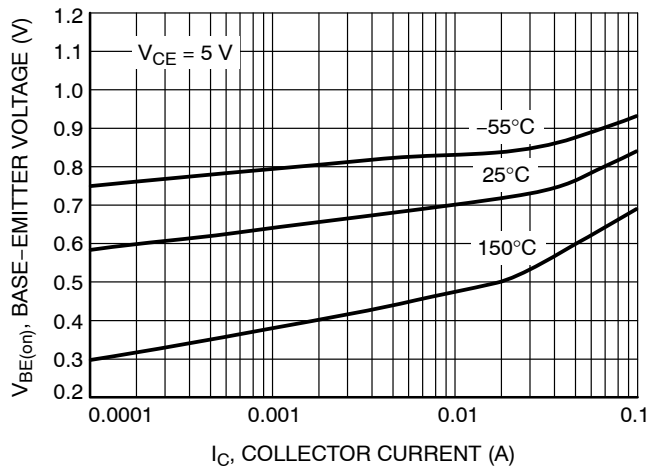

Figure 44. Base Emitter Voltage vs. Collector Current

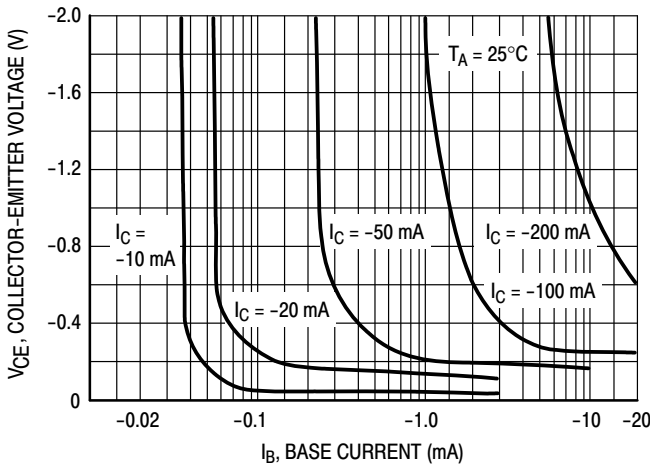

Figure 45. Collector Saturation Region

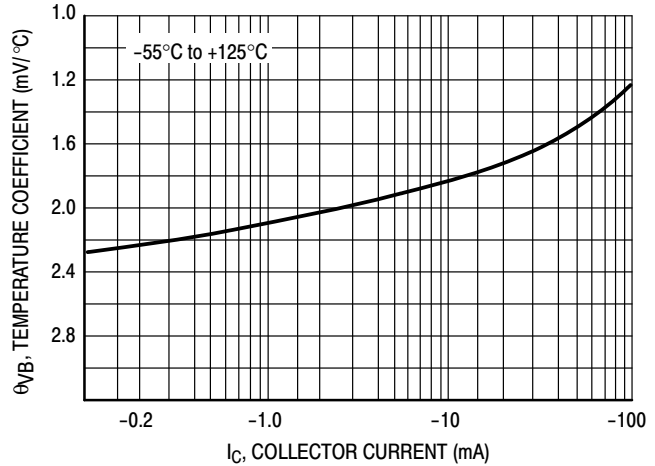

Figure 46. Base-Emitter Temperature Coefficient

BC846BPDW1, BC847BPDW1, BC848CPDW1 Series

TYPICAL PNP CHARACTERISTICS – BC848 SERIES



Figure 47. Capacitances

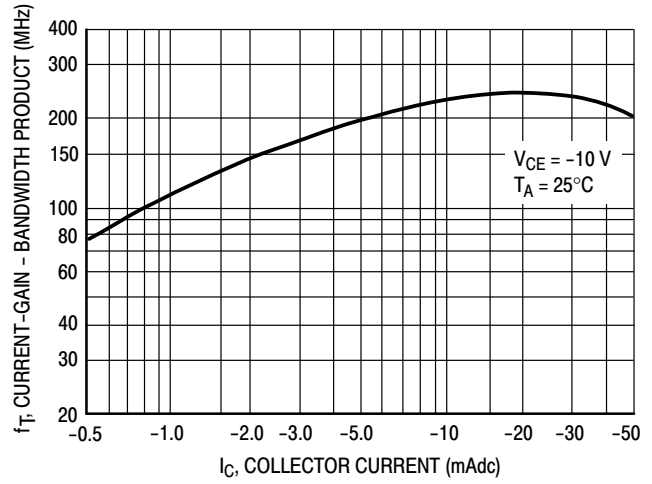

Figure 48. Current-Gain - Bandwidth Product

BC846BPDW1, BC847BPDW1, BC848CPDW1 Series

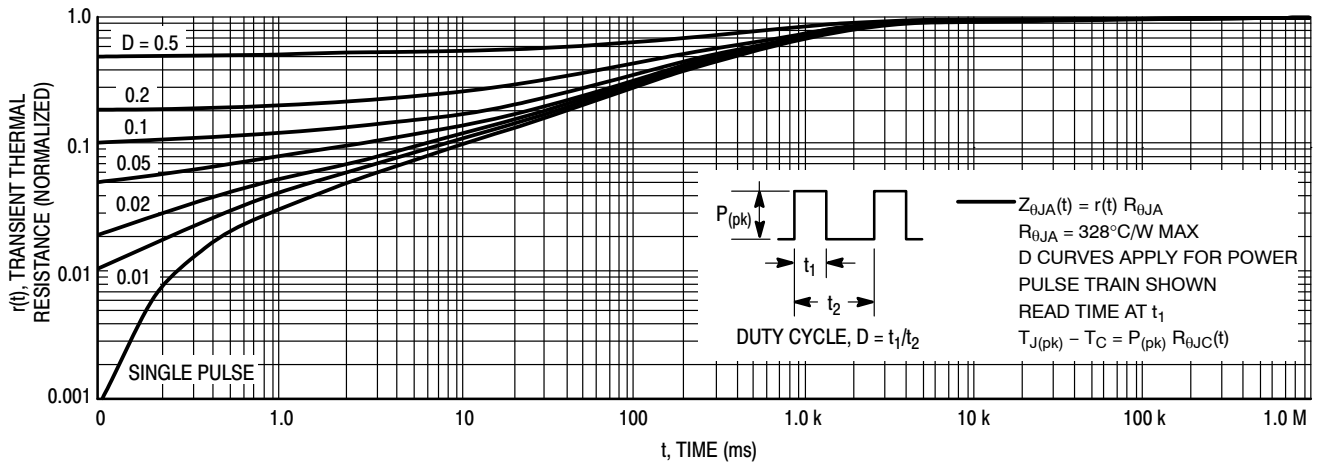

Figure 49. Thermal Response

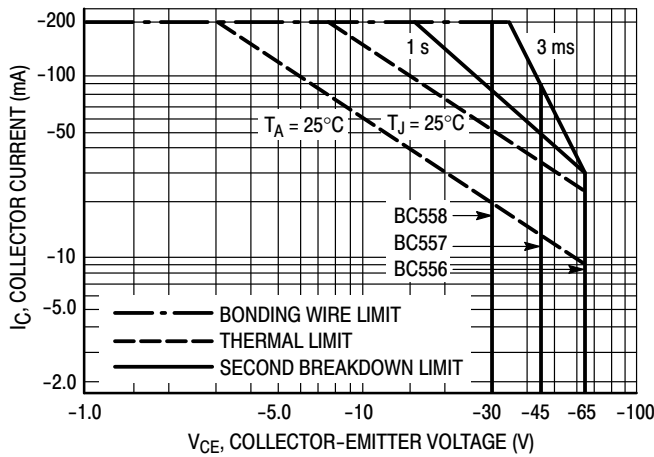

Figure 50. Active Region Safe Operating Area

The safe operating area curves indicate I_C - V_{CE} limits of the transistor that must be observed for reliable operation. Collector load lines for specific circuits must fall below the limits indicated by the applicable curve.

The data of Figure 50 is based upon $T_{J(pk)} = 150^\circ\text{C}$; T_C or T_A is variable depending upon conditions. Pulse curves are valid for duty cycles to 10% provided $T_{J(pk)} \leq 150^\circ\text{C}$. $T_{J(pk)}$ may be calculated from the data in Figure 49. At high case or ambient temperatures, thermal limitations will reduce the power that can be handled to values less than the limitations imposed by the secondary breakdown.

BC846BPDW1, BC847BPDW1, BC848CPDW1 Series

PACKAGE DIMENSIONS

SC-88/SOT-363/SC70-6
CASE 419B-02
ISSUE Y

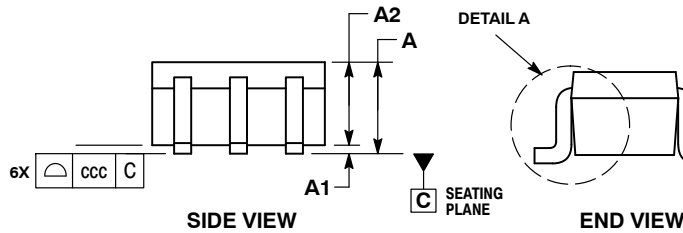
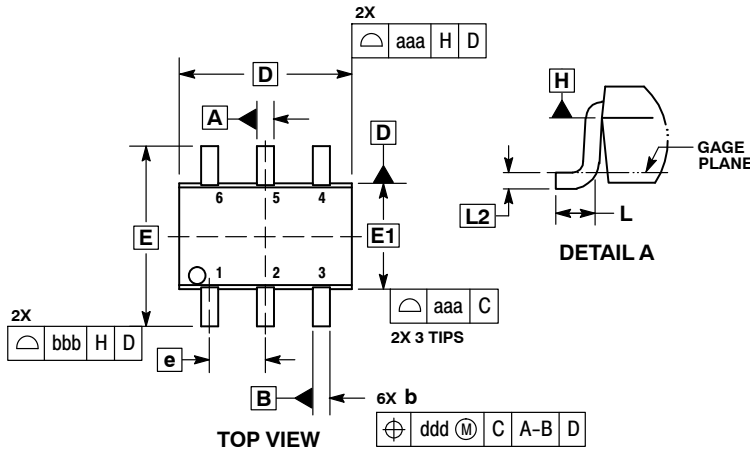

- NOTES:
1. DIMENSIONING AND TOLERANCING PER ASME Y14.5M, 1994.
 2. CONTROLLING DIMENSION: MILLIMETERS.
 3. DIMENSIONS D AND E1 DO NOT INCLUDE MOLD FLASH, PROTRUSIONS, OR GATE BURRS. MOLD FLASH, PROTRUSIONS, OR GATE BURRS SHALL NOT EXCEED 0.20 PER END.
 4. DIMENSIONS D AND E1 AT THE OUTERMOST EXTREMES OF THE PLASTIC BODY AND DATUM H.
 5. DATUMS A AND B ARE DETERMINED AT DATUM H.
 6. DIMENSIONS b AND c APPLY TO THE FLAT SECTION OF THE LEAD BETWEEN 0.08 AND 0.15 FROM THE TIP.
 7. DIMENSION b DOES NOT INCLUDE DAMBAR PROTRUSION. ALLOWABLE DAMBAR PROTRUSION SHALL BE 0.08 TOTAL IN EXCESS OF DIMENSION b AT MAXIMUM MATERIAL CONDITION. THE DAMBAR CANNOT BE LOCATED ON THE LOWER RADIUS OF THE FOOT.

DIM	MILLIMETERS			INCHES		
	MIN	NOM	MAX	MIN	NOM	MAX
A	---	---	1.10	---	---	0.043
A1	0.00	---	0.10	0.000	---	0.004
A2	0.70	0.90	1.00	0.027	0.035	0.039
b	0.15	0.20	0.25	0.006	0.008	0.010
C	0.08	0.15	0.22	0.003	0.006	0.009
D	1.80	2.00	2.20	0.070	0.078	0.086
E	2.00	2.10	2.20	0.078	0.082	0.086
E1	1.15	1.25	1.35	0.045	0.049	0.053
e	0.65 BSC			0.026 BSC		
L	0.26	0.36	0.46	0.010	0.014	0.018
L2	0.15 BSC			0.006 BSC		
aaa	0.15			0.006		
bbb	0.30			0.012		
ccc	0.10			0.004		
ddd	0.10			0.004		

- STYLE 1:
PIN 1. EMITTER 2
2. BASE 2
3. COLLECTOR 1
4. EMITTER 1
5. BASE 1
6. COLLECTOR 2

RECOMMENDED SOLDERING FOOTPRINT*

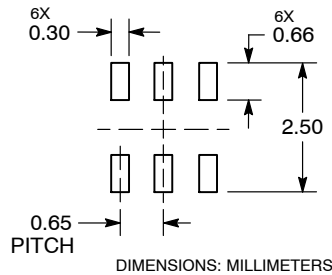

*For additional information on our Pb-Free strategy and soldering details, please download the ON Semiconductor Soldering and Mounting Techniques Reference Manual, SOLDERRM/D.

ON Semiconductor and are registered trademarks of Semiconductor Components Industries, LLC (SCILLC). SCILLC owns the rights to a number of patents, trademarks, copyrights, trade secrets, and other intellectual property. A listing of SCILLC's product/patent coverage may be accessed at www.onsemi.com/site/pdf/Patent-Marking.pdf. SCILLC reserves the right to make changes without further notice to any products herein. SCILLC makes no warranty, representation or guarantee regarding the suitability of its products for any particular purpose, nor does SCILLC assume any liability arising out of the application or use of any product or circuit, and specifically disclaims any and all liability, including without limitation special, consequential or incidental damages. "Typical" parameters which may be provided in SCILLC data sheets and/or specifications can and do vary in different applications and actual performance may vary over time. All operating parameters, including "Typicals" must be validated for each customer application by customer's technical experts. SCILLC does not convey any license under its patent rights nor the rights of others. SCILLC products are not designed, intended, or authorized for use as components in systems intended for surgical implant into the body, or other applications intended to support or sustain life, or for any other application in which the failure of the SCILLC product could create a situation where personal injury or death may occur. Should Buyer purchase or use SCILLC products for any such unintended or unauthorized application, Buyer shall indemnify and hold SCILLC and its officers, employees, subsidiaries, affiliates, and distributors harmless against all claims, costs, damages, and expenses, and reasonable attorney fees arising out of, directly or indirectly, any claim of personal injury or death associated with such unintended or unauthorized use, even if such claim alleges that SCILLC was negligent regarding the design or manufacture of the part. SCILLC is an Equal Opportunity/Affirmative Action Employer. This literature is subject to all applicable copyright laws and is not for resale in any manner.

PUBLICATION ORDERING INFORMATION

LITERATURE FULFILLMENT:
Literature Distribution Center for ON Semiconductor
P.O. Box 5163, Denver, Colorado 80217 USA
Phone: 303-675-2175 or 800-344-3860 Toll Free USA/Canada
Fax: 303-675-2176 or 800-344-3867 Toll Free USA/Canada
Email: orderlit@onsemi.com

N. American Technical Support: 800-282-9855 Toll Free
USA/Canada
Europe, Middle East and Africa Technical Support:
Phone: 421 33 790 2910
Japan Customer Focus Center
Phone: 81-3-5817-1050

ON Semiconductor Website: www.onsemi.com
Order Literature: <http://www.onsemi.com/orderlit>
For additional information, please contact your local Sales Representative