

Aluminum electrolytic capacitors

Capacitors with screw terminals

Series/Type: B43713, B43733

Date: December 2014

Long-life grade capacitors

Applications

- Frequency converters
- Wind power converters
- Solar inverters
- Professional power supplies
- Uninterruptible power supplies

Features

- High ripple current capability
- Extra long useful life
- High reliability
- Extremely good electrical characteristics and small dimensions
- All-welded construction ensures reliable electrical contact
- PAPR terminals available (Protection Against Polarity Reversal)
- Version available with an optimized base cooling design (heat sink mounting) and featuring up to 2times the ripple current capability
- Self-extinguishing electrolyte
- RoHS-compatible

Construction

- Charge-discharge proof, polar
- Aluminum case with insulating sleeve
- Poles with screw terminal connections
- Mounting with ring clips, clamps or threaded stud
- The bases of types with threaded stud are not insulated

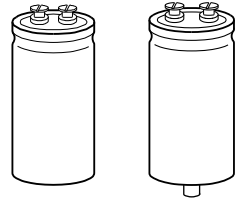
B43713
B43733

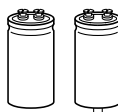
Specifications and characteristics in brief

Rated voltage V_R	200 ... 500 V DC			
Surge voltage V_S	$1.15 \cdot V_R$ (for $V_R \leq 250$ V DC) $1.10 \cdot V_R$ (for $V_R \geq 350$ V DC)			
Rated capacitance C_R	820 ... 33000 μ F			
Capacitance tolerance	$\pm 20\% \triangleq M$			
Dissipation factor $\tan \delta$ (20 °C, 120 Hz)	≤ 0.20			
Leakage current I_{leak} (20 °C, 5 min)	$I_{leak} \leq 0.020 \mu A \cdot \left(\frac{C_R}{\mu F} \cdot \frac{V_R}{V} \right)^{0.85} + 4 \mu A$			
Self-inductance ESL	d = 51.6 mm: approx. 15 nH d \geq 64.3 mm: approx. 20 nH			
Useful life ¹⁾ 85 °C; V_R ; $I_{AC,R}$	200 ... 450 V	500 V	Requirements: $ \Delta C/C \leq 15\%$ of initial value $\tan \delta \leq 1.75$ times initial specified limit $I_{leak} \leq$ initial specified limit	
	> 15000 h	> 12000 h		
Voltage endurance test 85 °C; V_R	2000 h		Post test requirements: $ \Delta C/C \leq 10\%$ of initial value $\tan \delta \leq 1.3$ times initial specified limit $I_{leak} \leq$ initial specified limit	
Vibration resistance test	To IEC 60068-2-6, test Fc: Frequency range 10 ... 55 Hz, displacement amplitude 0.75 mm, acceleration max. 10 g, duration 3 \times 2 h. Capacitor mounted by its body which is rigidly clamped to the work surface.			
Characteristics at low temperature	Max. impedance ratio at 100 Hz	V_R	≤ 250 V	≥ 350 V
		$Z_{-25^\circ C} / Z_{20^\circ C}$	5	4
		$Z_{-40^\circ C} / Z_{20^\circ C}$	20	16
IEC climatic category	To IEC 60068-1: 25/085/56 (–25 °C/+85 °C/56 days damp heat test) The capacitors can be operated in the temperature range of –40 °C to +85 °C but the impedance at –40 °C should be taken into consideration.			
Detail specification	Similar to CECC 30301-803, CECC 30301-807			
Sectional specification	IEC 60384-4			

1) Refer to chapter "General technical information, 5 Useful life" on how to interpret useful life.

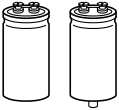

B43713, B43733

Extra long useful life – 85 °C

Ripple current capability

Due to the ripple current capability of the contact elements, the following current upper limits must not be exceeded:

Capacitor diameter	51.6 mm	64.3 mm	76.9 mm	90 mm
$I_{AC,max}$	34 A	57 A	67 A	80 A

Dimensional drawings

B43713

Ring clip/clamp mounting

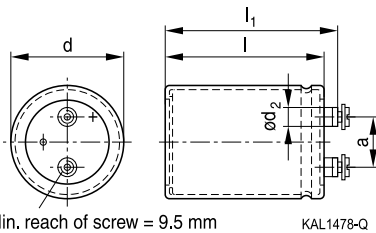

M5: Min. reach of screw = 9.5 mm

M6: Min. reach of screw = 12 mm

B43733

Threaded stud mounting

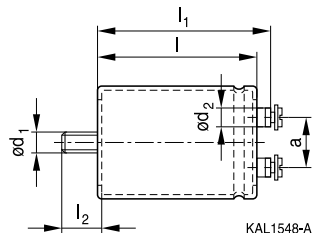

Positive pole marking: +

For types with threaded stud the base is not insulated. Also refer to the mounting instructions in chapter "Capacitors with screw terminals – Accessories".

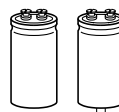
Dimensions and weights (Standard capacitors, without heat sink)

Terminal	Dimensions (mm) with insulating sleeve							Approx. weight (g)
	d	l ±1	l ₁ ± 1	l ₂ +0/-1	d ₁	d ₂ max.	a +0.2/-0.4	
M5	51.6 +0.5/-1	80.7	87.2	17	M12	10.2	22.2	220
M5	51.6 +0.5/-1	96.7	103.2	17	M12	10.2	22.2	250
M5	51.6 +0.5/-1	105.7	112.2	17	M12	10.2	22.2	280
M5	51.6 +0.5/-1	118.2	124.7	17	M12	10.2	22.2	320
M5	51.6 +0.5/-1	130.7	137.2	17	M12	10.2	22.2	350
M5	64.3 +0.5/-1	80.7	87.2	17	M12	13.2	28.5	370
M5	64.3 +0.5/-1	96.7	103.2	17	M12	13.2	28.5	400
M5	64.3 +0.5/-1	105.7	112.2	17	M12	13.2	28.5	440
M5	64.3 +0.5/-1	118.2	124.7	17	M12	13.2	28.5	510
M5	64.3 +0.5/-1	130.7	137.2	17	M12	13.2	28.5	600
M5	64.3 +0.5/-1	143.2	149.7	17	M12	13.2	28.5	630
M6	76.9 +0.5/-1	96.7	102.5	17	M12	17.7	31.7	570
M6	76.9 +0.5/-1	105.7	111.5	17	M12	17.7	31.7	620
M6	76.9 +0.5/-1	118.2	124.0	17	M12	17.7	31.7	700
M6	76.9 +0.5/-1	130.7	136.5	17	M12	17.7	31.7	800
M6	76.9 +0.5/-1	143.2	149.0	17	M12	17.7	31.7	840
M6	76.9 +0.5/-1	156.2	162.0	17	M12	17.7	31.7	920
M6	76.9 +0.5/-1	168.7	174.5	17	M12	17.7	31.7	1000
M6	76.9 +0.5/-1	190.7	196.5	17	M12	17.7	31.7	1150
M6	76.9 +0.5/-1	220.7	226.5	17	M12	17.7	31.7	1300
M6	90.0 +0.5/-1.5	120.2	125.3	17	M12	17.7	31.7	1000
M6	90.0 +0.5/-1.5	144.5	149.8	17	M12	17.7	31.7	1200
M6	90.0 +0.5/-1.5	170.0	175.3	17	M12	17.7	31.7	1400
M6	90.0 +0.5/-1.5	197.0	202.3	17	M12	17.7	31.7	1700
M6	90.0 +0.5/-1.5	221.0	226.3	17	M12	17.7	31.7	1900

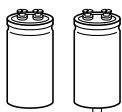

B43713, B43733

Extra long useful life – 85 °C

Packing

Capacitor diameter d (mm)	length l (mm)	Packing units (pcs.)
51.6	all	36
64.3	all	25

Capacitor diameter d (mm)	length l (mm)	Packing units (pcs.)
76.9	≤168.7	16
	>168.7	12
90.0	all	9



For ecological reasons the packing is pure cardboard.

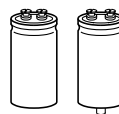

Special designs

■ PAPER terminal style

With our PAPER terminal style (**Protection Against Polarity Reversal**) we offer an optional mechanical feature in addition to the visual polarity marking on the cover disk and the sleeve, which prevents from mounting in reverse polarity. The non-circular shape of the terminals and their arrangement perpendicular to each other enables the user to definitely prevent wrong mounting with respect to polarity (Poka Yoke).

Dimensional drawing of PAPER terminal configuration

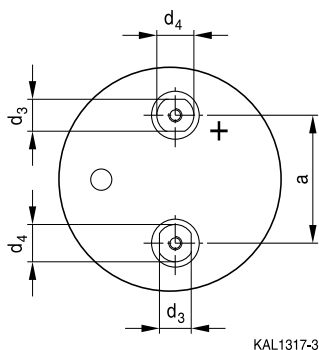

Dimensions for PAPER terminal style (mm)

Can diameter d	Terminal	d ₃ ±0.1	d ₄ ±0.1	a +0.2/-0.4	Min. reach of screw	
					Standard design #050	For heat sink mounting #057
51.6	M5	10	13	22.2	9.5	–
64.3	M5	13	15	28.5	9.5	7.3
76.9	M6	13	15	31.7	12.0	9.7
90.0	M6	13	15	31.7	12.0	9.7

All other dimensions of the capacitor such as diameter d, case length l and overall length l₁ are identical with those of standard capacitors of this series. Please refer to the tables "Dimensions and weights" (standard types) and "Dimensions and weights for heat sink mounting" (special designs).

■ For heat sink mounting

Please refer to chapter "General technical information, 5.2.2 Base cooling with heat sink". This version is available only for capacitors without threaded stud and for diameters ≥ 64.3 mm.

Regarding ripple current and useful life, please refer to chapter "General technical information, 5 Useful life".

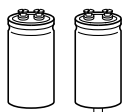

B43713, B43733

Extra long useful life – 85 °C

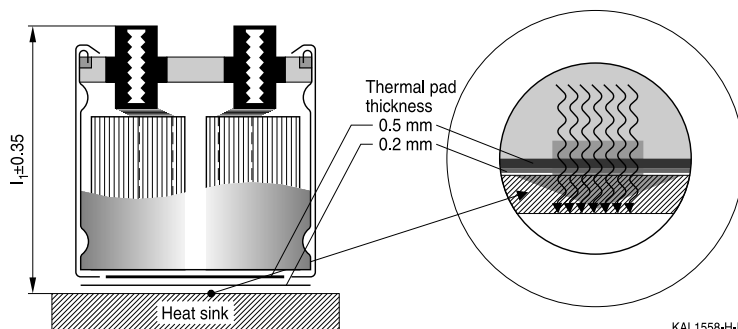

KAL1558-H-E

Dimensions and weights for heat sink mounting:

Terminal	Dimensions (mm) with insulating sleeve					Approx. weight g
	d	$l_1 \pm 1$	$l_1 \pm 0.35$	$d_2 \text{ max.}$	a +0.2/-0.4	
M5	64.3 +0.5/-1	80.7	86.3	13.2	28.5	370
M5	64.3 +0.5/-1	96.7	102.3	13.2	28.5	400
M5	64.3 +0.5/-1	105.7	111.3	13.2	28.5	440
M6	76.9 +0.5/-1	96.7	101.6	17.7	31.7	570
M6	76.9 +0.5/-1	105.7	110.6	17.7	31.7	620
M6	76.9 +0.5/-1	118.2	123.1	17.7	31.7	700
M6	90.0 +0.5/-1.5	120.0	124.4	17.7	31.7	1000
M6	90.0 +0.5/-1.5	144.5	148.9	17.7	31.7	1200

Dimensions for other sizes are available upon request.

Ordering codes:

Design	Identification in third block of ordering code	Remark
For heat sink mounting	M007	For capacitors with diameter $d \geq 64.3$ mm and without threaded stud
PAPR terminal style	M050	
PAPR terminal style and heat sink mounting	M057	For capacitors with diameter $d \geq 64.3$ mm and without threaded stud

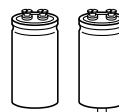

Accessories

The following items are included in the delivery package, but are not fastened to the capacitors:

	Thread	Toothed washers	Screws/nuts	Maximum torque
For terminals	M5	A 5.1 DIN 6797	DIN 7985 / ISO 7045-M5 × 10-5.6-Z	2.5 Nm thread depth t ≥ 8 mm
	M6	A 6.4 DIN 6797	DIN 7985 / ISO 7045-M6 × 12-5.6-Z	4.0 Nm thread depth t ≥ 9.5 mm
For mounting	M12	J 12.5 DIN 6797	Hex nut BM 12 DIN 439	10 Nm

The following items must be ordered separately. For details, refer to chapter "Capacitors with screw terminals – Accessories".

Item	Type
Ring clips	B44030
Clamps for capacitors with $d \geq 64.3$ mm	B44030
Insulating parts	B44020

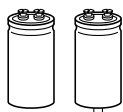
B43713, B43733
Extra long useful life – 85 °C
Overview of available types

V_R (V DC)	200	250	350	400	450	500
	Case dimensions $d \times l$ (mm)					
C_R (μ F)						
820						51.6 × 80.7
1000					51.6 × 80.7	51.6 × 96.7
1200					51.6 × 96.7	51.6 × 105.7 64.3 × 80.7
1500			51.6 × 80.7	51.6 × 80.7	51.6 × 105.7 64.3 × 80.7	51.6 × 130.7 64.3 × 96.7
1800			51.6 × 96.7	51.6 × 96.7	51.6 × 130.7 64.3 × 96.7	64.3 × 105.7
2200			51.6 × 105.7 64.3 × 80.7	51.6 × 105.7 64.3 × 80.7	64.3 × 105.7	64.3 × 118.2 76.9 × 96.7
2700		51.6 × 80.7	51.6 × 118.2 64.3 × 80.7	51.6 × 118.2 64.3 × 80.7	64.3 × 118.2 76.9 × 96.7	64.3 × 143.2 76.9 × 105.7
3300	51.6 × 80.7	51.6 × 80.7	64.3 × 96.7	64.3 × 96.7	64.3 × 143.2 76.9 × 105.7	76.9 × 130.7
3900	51.6 × 96.7	51.6 × 105.7 64.3 × 80.7	64.3 × 105.7 76.9 × 96.7	64.3 × 105.7 76.9 × 96.7	76.9 × 118.2	76.9 × 143.2
4700	51.6 × 105.7 64.3 × 80.7	51.6 × 130.7 64.3 × 96.7	64.3 × 130.7 76.9 × 96.7	64.3 × 130.7 76.9 × 96.7	76.9 × 143.2 90.0 × 120.0	90.0 × 144.5
5600	51.6 × 118.2 64.3 × 96.7	64.3 × 96.7	64.3 × 143.2 76.9 × 118.2	64.3 × 143.2 76.9 × 118.2	76.9 × 156.2 90.0 × 144.5	
6800	64.3 × 96.7	64.3 × 118.2 76.9 × 96.7	76.9 × 130.7 90.0 × 120.0	76.9 × 130.7 90.0 × 120.0	76.9 × 190.7 90.0 × 170.0	
8200	64.3 × 118.2 76.9 × 96.7	64.3 × 130.7 76.9 × 105.7	76.9 × 156.2 90.0 × 120.0	76.9 × 168.7 90.0 × 120.0	76.9 × 220.7 90.0 × 170.0	
10000	64.3 × 130.7 76.9 × 105.7	76.9 × 118.2 90.0 × 120.0	76.9 × 168.7 90.0 × 144.5	76.9 × 220.7 90.0 × 144.5	90.0 × 221.0	
12000	76.9 × 118.2	76.9 × 143.2 90.0 × 120.0	76.9 × 220.7	90.0 × 197.0		
15000	76.9 × 143.2 90.0 × 120.0	76.9 × 168.7 90.0 × 144.5	90.0 × 197.0	90.0 × 221.0		
18000	76.9 × 156.2 90.0 × 144.5	76.9 × 190.7 90.0 × 170.0	90.0 × 221.0			
22000	76.9 × 190.7 90.0 × 170.0	76.9 × 220.7 90.0 × 197.0				

B43713, B43733

Extra long useful life – 85 °C

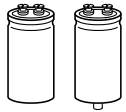

V_R (V DC)	200	250	350	400	450	500
	Case dimensions $d \times l$ (mm)					
C_R (μF)						
27000	76.9 × 220.7 90.0 × 197.0	90.0 × 221.0				
33000	90.0 × 221.0					

The capacitance and voltage ratings listed above are available in different cases upon request.

Other voltage and capacitance ratings are also available upon request.

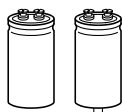
B43713, B43733
Extra long useful life – 85 °C
Technical data and ordering codes

C_R 100 Hz 20 °C μF	Case dimensions $d \times l$ mm	ESR_{typ} 100 Hz 20 °C $\text{m}\Omega$	ESR_{typ} 300 Hz 60 °C $\text{m}\Omega$	Z_{max} 10 kHz 20 °C $\text{m}\Omega$	$I_{\text{AC,max}}$ 100 Hz 60 °C A	$I_{\text{AC,R}}$ 100 Hz 85 °C A	Ordering code (composition see below)
$V_R = 200 \text{ V DC}$							
3300	51.6 × 80.7	50	15	85	15.8	8.59	B437*3A2338M0##
3900	51.6 × 96.7	40	12	70	17.9	9.78	B437*3A2398M0##
4700	51.6 × 105.7	36	11	60	20.1	10.9	B437*3A2478M0##
4700	64.3 × 80.7	36	10	60	21.0	11.4	B437*3B2478M0##
5600	51.6 × 118.2	30	9.1	50	22.5	12.2	B437*3A2568M0##
5600	64.3 × 96.7	30	8.3	50	23.6	12.9	B437*3B2568M0##
6800	64.3 × 96.7	26	7.7	45	25.8	14.0	B437*3A2688M0##
8200	64.3 × 118.2	20	6.2	34	29.6	16.0	B437*3A2828M0##
8200	76.9 × 96.7	20	5.6	34	33.1	18.0	B437*3B2828M0##
10000	64.3 × 130.7	17	5.5	30	33.2	18.0	B437*3A2109M0##
10000	76.9 × 105.7	17	4.8	28	36.9	20.0	B437*3B2109M0##
12000	76.9 × 118.2	14	4.1	24	41.2	22.3	B437*3A2129M0##
15000	76.9 × 143.2	11	3.4	19	47.6	25.8	B437*3A2159M0##
15000	90.0 × 120.0	11	3.2	19	51.0	28.4	B437*3B2159M0##
18000	76.9 × 156.2	9.5	3.0	17	53.1	28.8	B437*3A2189M0##
18000	90.0 × 144.5	9.2	2.7	16	57.1	31.8	B437*3B2189M0##
22000	76.9 × 190.7	7.8	2.5	14	61.0	33.9	B437*3A2229M0##
22000	90.0 × 170.0	7.6	2.2	14	64.4	35.9	B437*3B2229M0##
27000	76.9 × 220.7	6.4	2.1	12	67.0	39.0	B437*3A2279M0##
27000	90.0 × 197.0	6.2	1.9	12	72.8	40.6	B437*3B2279M0##
33000	90.0 × 221.0	5.2	1.7	9.8	80.0	45.9	B437*3A2339M0##

Composition of ordering code

* = Mounting style

- 1 = for capacitors with ring clip/clamp mounting
- 3 = for capacitors with threaded stud

= Design

- 00 = for standard capacitors
- 07 = for heat sink mounting (only for $d \geq 64.3 \text{ mm}$ and without threaded stud)
- 50 = for terminals with PAPR style
- 57 = for terminals with PAPR style and heat sink mounting (only for $d \geq 64.3 \text{ mm}$ and without threaded stud)

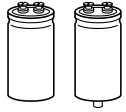
Technical data and ordering codes

C_R	Case dimensions	ESR_{typ} 100 Hz 20 °C μF	ESR_{typ} 300 Hz 60 °C $m\Omega$	Z_{max} 10 kHz 20 °C $m\Omega$	$I_{AC,max}$ 100 Hz 60 °C A	$I_{AC,R}$ 100 Hz 85 °C A	Ordering code (composition see below)
$V_R = 250$ V DC							
2700	51.6 × 80.7	55	16	95	13.6	7.28	B437*3E2278M0##
3300	51.6 × 80.7	50	15	80	14.8	7.88	B437*3E2338M0##
3900	51.6 × 105.7	36	11	55	18.2	9.69	B437*3E2398M0##
3900	64.3 × 80.7	34	10	55	18.9	10.0	B437*3F2398M0##
4700	51.6 × 130.7	28	8.7	50	21.1	11.2	B437*3E2478M0##
4700	64.3 × 96.7	28	8.5	45	21.4	11.4	B437*3F2478M0##
5600	64.3 × 96.7	24	8.0	40	23.2	12.3	B437*3E2568M0##
6800	64.3 × 118.2	20	6.4	34	26.8	14.2	B437*3E2688M0##
6800	76.9 × 96.7	20	5.7	32	29.8	15.8	B437*3F2688M0##
8200	64.3 × 130.7	17	5.7	28	30.1	16.0	B437*3E2828M0##
8200	76.9 × 105.7	17	5.0	28	33.1	17.6	B437*3F2828M0##
10000	76.9 × 118.2	14	4.2	22	37.3	19.9	B437*3E2109M0##
10000	90.0 × 120.0	13	3.6	22	41.2	22.5	B437*3F2109M0##
12000	76.9 × 143.2	11	3.5	19	42.3	22.5	B437*3E2129M0##
12000	90.0 × 120.0	11	3.4	19	45.3	24.7	B437*3F2129M0##
15000	76.9 × 168.7	9.2	2.9	16	49.0	26.7	B437*3E2159M0##
15000	90.0 × 144.5	9.0	2.7	15	51.8	28.3	B437*3F2159M0##
18000	76.9 × 190.7	7.8	2.6	14	55.4	30.2	B437*3E2189M0##
18000	90.0 × 170.0	7.6	2.3	13	58.0	31.7	B437*3F2189M0##
22000	76.9 × 220.7	6.4	2.2	12	63.8	34.8	B437*3E2229M0##
22000	90.0 × 197.0	6.2	2.0	11	65.6	35.9	B437*3F2229M0##
27000	90.0 × 221.0	5.2	1.7	9.4	74.7	40.8	B437*3E2279M0##

Composition of ordering code

* = Mounting style

- 1 = for capacitors with ring clip/clamp mounting
- 3 = for capacitors with threaded stud

= Design

- 00 = for standard capacitors
- 07 = for heat sink mounting (only for $d \geq 64.3$ mm and without threaded stud)
- 50 = for terminals with PAPR style
- 57 = for terminals with PAPR style and heat sink mounting (only for $d \geq 64.3$ mm and without threaded stud)

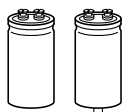
B43713, B43733
Extra long useful life – 85 °C
Technical data and ordering codes

C_R	Case dimensions	ESR_{typ} 100 Hz 20 °C μF	ESR_{typ} 300 Hz 60 °C $m\Omega$	Z_{max} 10 kHz 20 °C $m\Omega$	$I_{AC,max}$ 100 Hz 60 °C A	$I_{AC,R}$ 100 Hz 85 °C A	Ordering code (composition see below)
$V_R = 350$ V DC							
1500	51.6 × 80.7	80	22	130	11.8	6.44	B437*3A4158M0##
1800	51.6 × 96.7	65	18	110	13.4	7.33	B437*3A4188M0##
2200	51.6 × 105.7	55	15	90	15.2	8.32	B437*3A4228M0##
2200	64.3 × 80.7	55	15	90	15.9	8.67	B437*3B4228M0##
2700	51.6 × 118.2	45	13	75	17.5	9.52	B437*3A4278M0##
2700	64.3 × 80.7	45	13	75	17.6	9.59	B437*3B4278M0##
3300	64.3 × 96.7	38	11	60	20.2	11.0	B437*3A4338M0##
3900	64.3 × 105.7	32	9.4	55	22.5	12.2	B437*3A4398M0##
3900	76.9 × 96.7	30	8.1	50	25.1	13.6	B437*3B4398M0##
4700	64.3 × 130.7	26	7.6	45	25.7	13.9	B437*3A4478M0##
4700	76.9 × 96.7	26	7.3	45	27.8	15.1	B437*3B4478M0##
5600	64.3 × 143.2	22	6.7	36	28.8	15.6	B437*3A4568M0##
5600	76.9 × 118.2	22	5.9	36	31.3	17.0	B437*3B4568M0##
6800	76.9 × 130.7	18	5.1	30	35.3	19.1	B437*3A4688M0##
6800	90.0 × 120.0	18	4.7	30	38.0	21.2	B437*3B4688M0##
8200	76.9 × 156.2	16	4.2	26	39.4	21.5	B437*3A4828M0##
8200	90.0 × 120.0	15	4.2	24	42.2	23.5	B437*3B4828M0##
10000	76.9 × 168.7	13	3.7	22	45.0	25.0	B437*3A4109M0##
10000	90.0 × 144.5	12	3.5	20	47.7	26.6	B437*3B4109M0##
12000	76.9 × 220.7	11	3.0	18	51.1	28.5	B437*3A4129M0##
15000	90.0 × 197.0	8.6	2.5	15	60.9	34.0	B437*3A4159M0##
18000	90.0 × 221.0	7.2	2.2	13	68.8	38.3	B437*3A4189M0##

Composition of ordering code

* = Mounting style

- 1 = for capacitors with ring clip/clamp mounting
- 3 = for capacitors with threaded stud

= Design

- 00 = for standard capacitors
- 07 = for heat sink mounting (only for $d \geq 64.3$ mm and without threaded stud)
- 50 = for terminals with PAPR style
- 57 = for terminals with PAPR style and heat sink mounting (only for $d \geq 64.3$ mm and without threaded stud)

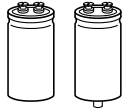
Technical data and ordering codes

C_R	Case dimensions	ESR_{typ} 100 Hz 20 °C μF	ESR_{typ} 300 Hz 60 °C $m\Omega$	Z_{max} 10 kHz 20 °C $m\Omega$	$I_{AC,max}$ 100 Hz 60 °C A	$I_{AC,R}$ 100 Hz 85 °C A	Ordering code (composition see below)
$V_R = 400$ V DC							
1500	51.6 × 80.7	85	22	130	11.8	6.44	B437*3A9158M0##
1800	51.6 × 96.7	70	18	110	13.4	7.33	B437*3A9188M0##
2200	51.6 × 105.7	55	15	90	15.3	8.34	B437*3A9228M0##
2200	64.3 × 80.7	55	15	90	15.9	8.66	B437*3B9228M0##
2700	51.6 × 118.2	45	13	75	17.5	9.55	B437*3A9278M0##
2700	64.3 × 80.7	45	14	75	17.6	9.59	B437*3B9278M0##
3300	64.3 × 96.7	38	11	65	20.2	11.0	B437*3A9338M0##
3900	64.3 × 105.7	32	9.7	55	22.5	12.2	B437*3A9398M0##
3900	76.9 × 96.7	32	8.3	50	25.1	13.6	B437*3B9398M0##
4700	64.3 × 130.7	28	7.8	45	25.8	14.0	B437*3A9478M0##
4700	76.9 × 96.7	26	7.5	45	27.9	15.1	B437*3B9478M0##
5600	64.3 × 143.2	24	6.9	38	29.0	15.7	B437*3A9568M0##
5600	76.9 × 118.2	22	6.1	36	31.3	17.0	B437*3B9568M0##
6800	76.9 × 130.7	19	5.2	30	35.4	19.2	B437*3A9688M0##
6800	90.0 × 120.0	18	4.8	30	38.1	21.2	B437*3B9688M0##
8200	76.9 × 168.7	14	4.0	22	42.4	23.6	B437*3A9828M0##
8200	90.0 × 120.0	15	4.4	26	42.3	23.5	B437*3B9828M0##
10000	76.9 × 220.7	11	3.2	18	48.7	27.1	B437*3A9109M0##
10000	90.0 × 144.5	13	3.6	22	48.0	26.7	B437*3B9109M0##
12000	90.0 × 197.0	9.5	2.7	16	56.4	31.4	B437*3A9129M0##
15000	90.0 × 221.0	7.7	2.3	13	65.8	36.6	B437*3A9159M0##

Composition of ordering code

* = Mounting style

- 1 = for capacitors with ring clip/clamp mounting
- 3 = for capacitors with threaded stud

= Design

- 00 = for standard capacitors
- 07 = for heat sink mounting (only for $d \geq 64.3$ mm and without threaded stud)
- 50 = for terminals with PAPR style
- 57 = for terminals with PAPR style and heat sink mounting (only for $d \geq 64.3$ mm and without threaded stud)

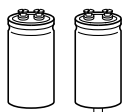
B43713, B43733
Extra long useful life – 85 °C
Technical data and ordering codes

C_R	Case dimensions	ESR_{typ} 100 Hz 20 °C	ESR_{typ} 300 Hz 60 °C	Z_{max} 10 kHz 20 °C	$I_{AC,max}$ 100 Hz 60 °C	$I_{AC,R}$ 100 Hz 85 °C	Ordering code (composition see below)
μF	$d \times l$ mm	$m\Omega$	$m\Omega$	$m\Omega$	A	A	
$V_R = 450$ V DC							
1000	51.6 × 80.7	120	28	190	9.62	5.29	B437*3A5108M0##
1200	51.6 × 96.7	100	24	160	10.8	5.99	B437*3A5128M0##
1500	51.6 × 105.7	80	20	130	12.6	6.95	B437*3A5158M0##
1500	64.3 × 80.7	80	19	130	13.1	7.20	B437*3B5158M0##
1800	51.6 × 130.7	65	16	110	14.4	7.95	B437*3A5188M0##
1800	64.3 × 96.7	65	16	110	14.7	8.10	B437*3B5188M0##
2200	64.3 × 105.7	55	14	85	16.7	9.20	B437*3A5228M0##
2700	64.3 × 118.2	45	11	70	19.1	10.5	B437*3A5278M0##
2700	76.9 × 96.7	45	11	70	20.8	11.4	B437*3B5278M0##
3300	64.3 × 143.2	36	9.3	60	21.9	12.0	B437*3A5338M0##
3300	76.9 × 105.7	36	9.0	60	23.5	12.9	B437*3B5338M0##
3900	76.9 × 118.2	30	7.7	50	26.1	14.3	B437*3A5398M0##
4700	76.9 × 143.2	26	6.4	40	29.4	16.2	B437*3A5478M0##
4700	90.0 × 120.0	26	6.2	40	31.4	17.6	B437*3B5478M0##
5600	76.9 × 156.2	22	5.5	34	33.1	18.2	B437*3A5568M0##
5600	90.0 × 144.5	22	5.2	34	34.6	19.5	B437*3B5568M0##
6800	76.9 × 190.7	18	4.6	28	37.8	21.3	B437*3A5688M0##
6800	90.0 × 170.0	17	4.4	28	39.0	22.0	B437*3B5688M0##
8200	76.9 × 220.7	15	3.9	24	43.2	24.4	B437*3A5828M0##
8200	90.0 × 170.0	15	3.8	24	44.4	25.0	B437*3B5828M0##
10000	90.0 × 221.0	12	3.1	20	50.2	28.3	B437*3A5109M0##

Composition of ordering code

* = Mounting style

- 1 = for capacitors with ring clip/clamp mounting
- 3 = for capacitors with threaded stud

= Design

- 00 = for standard capacitors
- 07 = for heat sink mounting (only for $d \geq 64.3$ mm and without threaded stud)
- 50 = for terminals with PAPR style
- 57 = for terminals with PAPR style and heat sink mounting (only for $d \geq 64.3$ mm and without threaded stud)

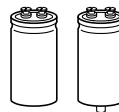
Technical data and ordering codes

C_R	Case dimensions	ESR_{typ} 100 Hz 20 °C μF	ESR_{typ} 300 Hz 60 °C $m\Omega$	Z_{max} 10 kHz 20 °C $m\Omega$	$I_{AC,max}$ 100 Hz 60 °C A	$I_{AC,R}$ 100 Hz 85 °C A	Ordering code (composition see below)
$V_R = 500$ V DC							
820	51.6 × 80.7	130	32	200	9.20	4.68	B437*3A6827M0##
1000	51.6 × 96.7	100	26	160	10.4	5.35	B437*3A6108M0##
1200	51.6 × 105.7	85	22	140	11.8	6.05	B437*3A6128M0##
1200	64.3 × 80.7	85	22	140	12.3	6.28	B437*3B6128M0##
1500	51.6 × 130.7	70	18	110	13.9	7.10	B437*3A6158M0##
1500	64.3 × 96.7	70	17	110	14.1	7.23	B437*3B6158M0##
1800	64.3 × 105.7	60	15	90	15.9	8.13	B437*3A6188M0##
2200	64.3 × 118.2	50	12	75	18.2	9.28	B437*3A6228M0##
2200	76.9 × 96.7	45	12	75	19.8	10.0	B437*3B6228M0##
2700	64.3 × 143.2	38	10	60	20.9	10.6	B437*3A6278M0##
2700	76.9 × 105.7	38	9.8	60	22.5	11.4	B437*3B6278M0##
3300	76.9 × 130.7	32	7.9	50	25.4	12.9	B437*3A6338M0##
3900	76.9 × 143.2	26	6.8	45	28.3	14.4	B437*3A6398M0##
4700	90.0 × 144.5	22	5.6	34	33.6	17.5	B437*3A6478M0##

Composition of ordering code

* = Mounting style

1 = for capacitors with ring clip/clamp mounting

3 = for capacitors with threaded stud

= Design

00 = for standard capacitors

07 = for heat sink mounting (only for $d \geq 64.3$ mm and without threaded stud)

50 = for terminals with PAPR style

57 = for terminals with PAPR style and heat sink mounting (only for $d \geq 64.3$ mm and without threaded stud)

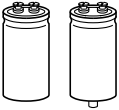

B43713, B43733

Extra long useful life – 85 °C

Useful life¹⁾

For useful life calculations, please use our web-based "AlCap Useful Life Calculation Tool", which can be found on the Internet under the following link

http://www.epcos.com/designtools/alu_useful_life/Useful_life.swf.

The AlCap Useful Life Calculation Tool provides calculations of useful life as well as additional data for selected capacitor types under operating conditions defined by the user.

Frequency characteristics of ESR

Typical behavior

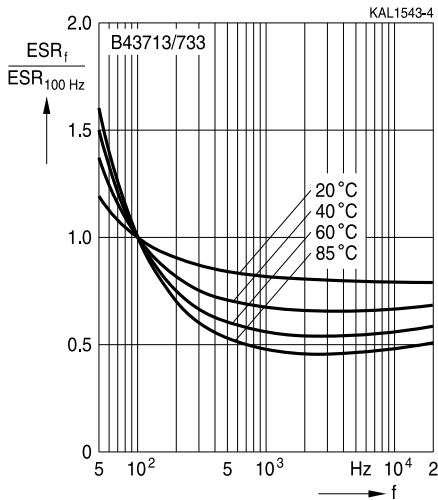

Impedance Z versus frequency f

Typical behavior at 20 °C

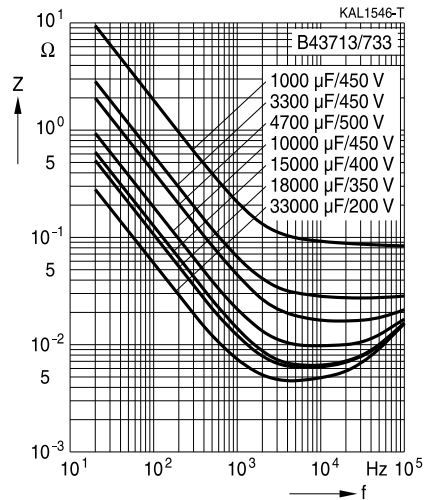

1) Refer to chapter "General technical information, 5 Useful life" on how to interpret useful life.

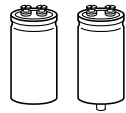

Cautions and warnings

Personal safety

The electrolytes used by EPCOS have been optimized both with a view to the intended application and with regard to health and environmental compatibility. They do not contain any solvents that are detrimental to health, e.g. dimethyl formamide (DMF) or dimethyl acetamide (DMAC).

Furthermore, some of the high-voltage electrolytes used by EPCOS are self-extinguishing.

As far as possible, EPCOS does not use any dangerous chemicals or compounds to produce operating electrolytes. However, in exceptional cases, such materials must be used in order to achieve specific physical and electrical properties because no alternative materials are currently known. However, the amount of dangerous materials used in our products is limited to an absolute minimum.

Materials and chemicals used in EPCOS aluminum electrolytic capacitors are continuously adapted in compliance with the EPCOS Corporate Environmental Policy and the latest EU regulations and guidelines such as RoHS, REACH/SVHC, GADSL, and ELV.

MDS (Material Data Sheets) are available on the EPCOS website for all types listed in the data book. MDS for customer specific capacitors are available upon request.

MSDS (Material Safety Data Sheets) are available for all of our electrolytes upon request.

Nevertheless, the following rules should be observed when handling aluminum electrolytic capacitors: No electrolyte should come into contact with eyes or skin. If electrolyte does come into contact with the skin, wash the affected areas immediately with running water. If the eyes are affected, rinse them for 10 minutes with plenty of water. If symptoms persist, seek medical treatment. Avoid inhaling electrolyte vapor or mists. Workplaces and other affected areas should be well ventilated. Clothing that has been contaminated by electrolyte must be changed and rinsed in water.

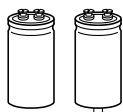

B43713, B43733

Extra long useful life – 85 °C

Product safety

The table below summarizes the safety instructions that must be observed without fail. A detailed description can be found in the relevant sections of chapter "General technical information".

Topic	Safety information	Reference chapter "General technical information"
Polarity	Make sure that polar capacitors are connected with the right polarity.	1 "Basic construction of aluminum electrolytic capacitors"
Reverse voltage	Voltages of opposite polarity should be prevented by connecting a diode.	3.1.6 "Reverse voltage"
Mounting position of screw-terminal capacitors	Screw terminal capacitors must not be mounted with terminals facing down unless otherwise specified.	11.1. "Mounting positions of capacitors with screw terminals"
Robustness of terminals	The following maximum tightening torques must not be exceeded when connecting screw terminals: M5: 2.5 Nm M6: 4.0 Nm	11.3 "Mounting torques"
Mounting of single-ended capacitors	The internal structure of single-ended capacitors might be damaged if excessive force is applied to the lead wires. Avoid any compressive, tensile or flexural stress. Do not move the capacitor after soldering to PC board. Do not pick up the PC board by the soldered capacitor. Do not insert the capacitor on the PC board with a hole space different to the lead space specified.	11.4 "Mounting considerations for single-ended capacitors"
Soldering	Do not exceed the specified time or temperature limits during soldering.	11.5 "Soldering"
Soldering, cleaning agents	Do not allow halogenated hydrocarbons to come into contact with aluminum electrolytic capacitors.	11.6 "Cleaning agents"
Upper category temperature	Do not exceed the upper category temperature.	7.2 "Maximum permissible operating temperature"
Passive flammability	Avoid external energy, e.g. fire.	8.1 "Passive flammability"

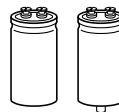

Topic	Safety information	Reference chapter "General technical information"
Active flammability	Avoid overload of the capacitors.	8.2 "Active flammability"
Maintenance	Make periodic inspections of the capacitors. Before the inspection, make sure that the power supply is turned off and carefully discharge the electricity of the capacitors. Do not apply excessive mechanical stress to the capacitor terminals when mounting.	10 "Maintenance"
Storage	Do not store capacitors at high temperatures or high humidity. Capacitors should be stored at +5 to +35 °C and a relative humidity of $\leq 75\%$.	7.3 "Shelf life and storage conditions"
		Reference chapter "Capacitors with screw terminals"
Breakdown strength of insulating sleeves	Do not damage the insulating sleeve, especially when ring clips are used for mounting.	"Screw terminals – accessories"

Display of ordering codes for EPCOS products

The ordering code for one and the same product can be represented differently in data sheets, data books, other publications and the website of EPCOS, or in order-related documents such as shipping notes, order confirmations and product labels. The varying representations of the ordering codes are due to different processes employed and do not affect the specifications of the respective products. Detailed information can be found on the Internet under www.epcos.com/orderingcodes

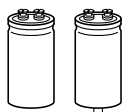

B43713, B43733

Extra long useful life – 85 °C

Symbols and terms

Symbol	English	German
C	Capacitance	Kapazität
C_R	Rated capacitance	Nennkapazität
C_S	Series capacitance	Serienkapazität
$C_{S,T}$	Series capacitance at temperature T	Serienkapazität bei Temperatur T
C_f	Capacitance at frequency f	Kapazität bei Frequenz f
d	Case diameter, nominal dimension	Gehäusedurchmesser, Nennmaß
d_{max}	Maximum case diameter	Maximaler Gehäusedurchmesser
ESL	Self-inductance	Eigeninduktivität
ESR	Equivalent series resistance	Ersatzserienwiderstand
ESR_f	Equivalent series resistance at frequency f	Ersatzserienwiderstand bei Frequenz f
ESR_T	Equivalent series resistance at temperature T	Ersatzserienwiderstand bei Temperatur T
f	Frequency	Frequenz
I	Current	Strom
I_{AC}	Alternating current (ripple current)	Wechselstrom
$I_{AC,RMS}$	Root-mean-square value of alternating current	Wechselstrom, Effektivwert
$I_{AC,f}$	Ripple current at frequency f	Wechselstrom bei Frequenz f
$I_{AC,max}$	Maximum permissible ripple current	Maximal zulässiger Wechselstrom
$I_{AC,R}$	Rated ripple current	Nennwechselstrom
I_{leak}	Leakage current	Reststrom
$I_{leak,op}$	Operating leakage current	Betriebsreststrom
l	Case length, nominal dimension	Gehäuselänge, Nennmaß
l_{max}	Maximum case length (without terminals and mounting stud)	Maximale Gehäuselänge (ohne Anschlüsse und Gewindebolzen)
R	Resistance	Widerstand
R_{ins}	Insulation resistance	Isolationswiderstand
R_{symm}	Balancing resistance	Symmetrierwiderstand
T	Temperature	Temperatur
ΔT	Temperature difference	Temperaturdifferenz
T_A	Ambient temperature	Umgebungstemperatur
T_C	Case temperature	Gehäusetemperatur
T_B	Capacitor base temperature	Temperatur des Gehäusebodens
t	Time	Zeit
Δt	Period	Zeitraum
t_b	Service life (operating hours)	Brauchbarkeitsdauer (Betriebszeit)

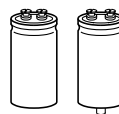

Symbol	English	German
V	Voltage	Spannung
V _F	Forming voltage	Formierspannung
V _{op}	Operating voltage	Betriebsspannung
V _R	Rated voltage, DC voltage	Nennspannung, Gleichspannung
V _S	Surge voltage	Spitzenspannung
X _C	Capacitive reactance	Kapazitiver Blindwiderstand
X _L	Inductive reactance	Induktiver Blindwiderstand
Z	Impedance	Scheinwiderstand
Z _T	Impedance at temperature T	Scheinwiderstand bei Temperatur T
tan δ	Dissipation factor	Verlustfaktor
λ	Failure rate	Ausfallrate
ε ₀	Absolute permittivity	Elektrische Feldkonstante
ε _r	Relative permittivity	Dielektrizitätszahl
ω	Angular velocity; 2 · π · f	Kreisfrequenz; 2 · π · f

Note

All dimensions are given in mm.

Important notes

The following applies to all products named in this publication:

1. Some parts of this publication contain **statements about the suitability of our products for certain areas of application**. These statements are based on our knowledge of typical requirements that are often placed on our products in the areas of application concerned. We nevertheless expressly point out **that such statements cannot be regarded as binding statements about the suitability of our products for a particular customer application**. As a rule, EPCOS is either unfamiliar with individual customer applications or less familiar with them than the customers themselves. For these reasons, it is always ultimately incumbent on the customer to check and decide whether an EPCOS product with the properties described in the product specification is suitable for use in a particular customer application.
2. We also point out that **in individual cases, a malfunction of electronic components or failure before the end of their usual service life cannot be completely ruled out in the current state of the art, even if they are operated as specified**. In customer applications requiring a very high level of operational safety and especially in customer applications in which the malfunction or failure of an electronic component could endanger human life or health (e.g. in accident prevention or lifesaving systems), it must therefore be ensured by means of suitable design of the customer application or other action taken by the customer (e.g. installation of protective circuitry or redundancy) that no injury or damage is sustained by third parties in the event of malfunction or failure of an electronic component.
3. **The warnings, cautions and product-specific notes must be observed.**
4. In order to satisfy certain technical requirements, **some of the products described in this publication may contain substances subject to restrictions in certain jurisdictions (e.g. because they are classed as hazardous)**. Useful information on this will be found in our Material Data Sheets on the Internet (www.epcos.com/material). Should you have any more detailed questions, please contact our sales offices.
5. We constantly strive to improve our products. Consequently, **the products described in this publication may change from time to time**. The same is true of the corresponding product specifications. Please check therefore to what extent product descriptions and specifications contained in this publication are still applicable before or when you place an order. We also **reserve the right to discontinue production and delivery of products**. Consequently, we cannot guarantee that all products named in this publication will always be available. The aforementioned does not apply in the case of individual agreements deviating from the foregoing for customer-specific products.
6. Unless otherwise agreed in individual contracts, **all orders are subject to the current version of the "General Terms of Delivery for Products and Services in the Electrical Industry" published by the German Electrical and Electronics Industry Association (ZVEI)**.

Important notes

7. The trade names EPCOS, Alu-X, CeraDiode, CeraLink, CeraPad, CeraPlas, CSMP, CSSP, CTVS, DeltaCap, DigiSiMic, DSSP, FilterCap, FormFit, LeaXield, MiniBlue, MiniCell, MKD, MKK, MLSC, MotorCap, PCC, PhaseCap, PhaseCube, PhaseMod, PhiCap, PQSine, SIFERRIT, SIFI, SIKOREL, SilverCap, SIMDAD, SiMic, SIMID, SineFormer, SIOV, SIP5D, SIP5K, TFAP, ThermoFuse, WindCap are **trademarks registered or pending** in Europe and in other countries. Further information will be found on the Internet at www.epcos.com/trademarks.vvv