

HIGH SPEED, EXTREMELY LOW NOISE LDO REGULATOR**AP2122****General Description**

The AP2122 series are positive voltage regulator ICs fabricated by CMOS process. Each of these ICs consists of a voltage reference, an error amplifier, a resistor network for setting output voltage, a current limit circuit for current protection and a chip enable circuit .

The AP2122 series feature high ripple rejection, low dropout voltage, low noise, high output voltage accuracy, and low current consumption which make them ideal for use in various battery-powered devices.

The AP2122 series have 1.5V, 1.8V, 2.5V, 2.8V, 3.0V, 3.2V and 3.3V versions.

The AP2122 are available in standard SOT-23-5 package.

Features

- Low Dropout Voltage at $I_{OUT}=100mA$: 150mV Typical (Except 1.5V Version)
- Low Standby Current: 0.1 μA Typical
- Low Quiescent Current: 25 μA Typical
- High Ripple Rejection: 70dB Typical ($f=10kHz$)
- Maximum Output Current: More Than 150mA (300mA Limit)
- Extremely Low Noise: 30 μV_{rms} (10Hz to 100kHz)
- Excellent Line Regulation: 4mV Typical
- Excellent Load Regulation: 12mV Typical
- High Output Voltage Accuracy: $\pm 2\%$
- Excellent Line and Load Transient Response
- Compatible with Low ESR Ceramic Capacitor (as Low as 1 μF)

Applications

- Mobile Phones, Cordless Phones
- MP3/4
- Portable Electronic Devices
- Cameras, Video Recorders
- Sub-board Power Supplies for Telecom Equipment
- Battery Powered Equipment

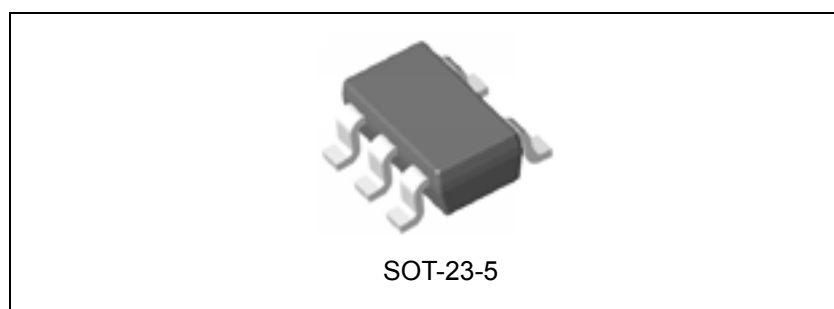

Figure 1. Package Type of AP2122

Pin Configuration

Figure 2. Pin Configuration of AP2122 (Top View)

Pin Description

| Pin Number | Pin Name | Function |
|------------|-----------|---|
| 1 | V_{OUT} | Regulated output voltage |
| 2 | GND | Ground |
| 3 | V_{IN} | Input voltage |
| 4 | CE | Active high enable input pin. Logic high=enable, logic low=shutdown |
| 5 | NC | No connection |

Functional Block Diagram

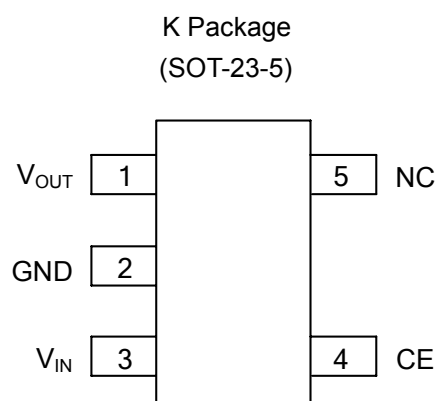
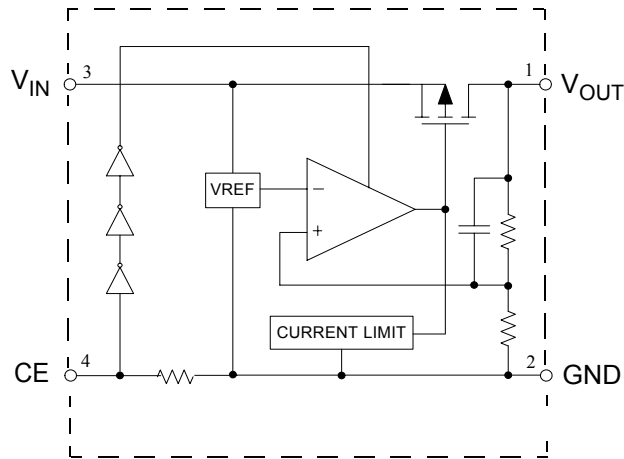

Figure 3. Functional Block Diagram of AP2122



HIGH SPEED, EXTREMELY LOW NOISE LDO REGULATOR

AP2122

Ordering Information

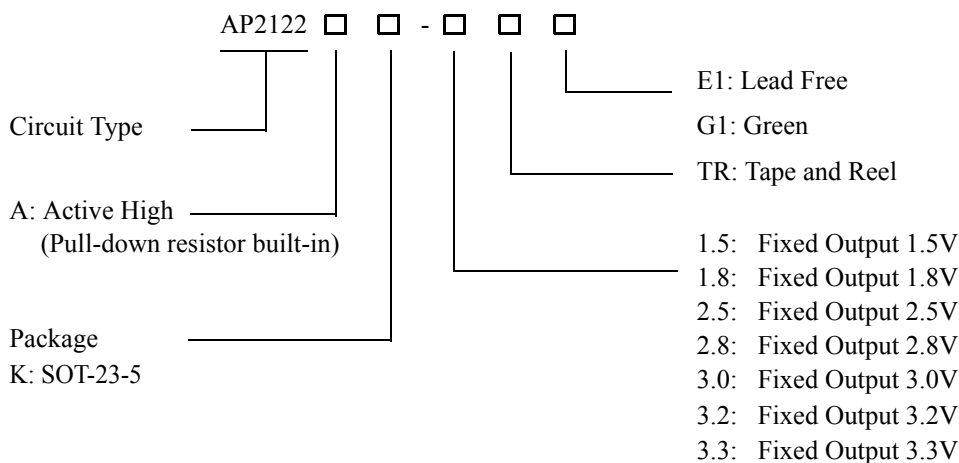

| Package | Temperature Range | Condition | Part Number | | Marking ID | | Packing Type |
|----------|-------------------|---|------------------|------------------|------------|-------|--------------|
| | | | Lead Free | Green | Lead Free | Green | |
| SOT-23-5 | -40 to 85°C | Active High (Pull-down resistor built-in) | AP2122AK-1.5TRE1 | AP2122AK-1.5TRG1 | E2Z | G2Z | Tape & Reel |
| | | Active High (Pull-down resistor built-in) | AP2122AK-1.8TRE1 | AP2122AK-1.8TRG1 | E2U | G2U | Tape & Reel |
| | | Active High (Pull-down resistor built-in) | AP2122AK-2.5TRE1 | AP2122AK-2.5TRG1 | E2V | G2V | Tape & Reel |
| | | Active High (Pull-down resistor built-in) | AP2122AK-2.8TRE1 | AP2122AK-2.8TRG1 | E2W | G2W | Tape & Reel |
| | | Active High (Pull-down resistor built-in) | AP2122AK-3.0TRE1 | AP2122AK-3.0TRG1 | E2X | G2X | Tape & Reel |
| | | Active High (Pull-down resistor built-in) | AP2122AK-3.2TRE1 | AP2122AK-3.2TRG1 | E3Y | G3Y | Tape & Reel |
| | | Active High (Pull-down resistor built-in) | AP2122AK-3.3TRE1 | AP2122AK-3.3TRG1 | E2Y | G2Y | Tape & Reel |

BCD Semiconductor's Pb-free products, as designated with "E1" suffix in the part number, are RoHS compliant. Products with "G1" suffix are available in green packages.

**HIGH SPEED, EXTREMELY LOW NOISE LDO REGULATOR****AP2122****Absolute Maximum Ratings (Note 1)**

| Parameter | Symbol | Value | Unit |
|-------------------------------------|---------------|----------------------|------|
| Input Voltage | V_{IN} | 6.5 | V |
| Enable Input Voltage | V_{CE} | -0.3 to $V_{IN}+0.3$ | V |
| Output Current | I_{OUT} | 300 | mA |
| Junction Temperature | T_J | 150 | °C |
| Storage Temperature Range | T_{STG} | -65 to 150 | °C |
| Lead Temperature (Soldering, 10sec) | T_{LEAD} | 260 | °C |
| Thermal Resistance (Note 2) | θ_{JA} | 250 | °C/W |
| ESD (Human Body Model) | ESD | 2000 | V |
| ESD (Machine Model) | ESD | 200 | V |

Note 1: Stresses greater than those listed under "Absolute Maximum Ratings" may cause permanent damage to the device. These are stress ratings only, and functional operation of the device at these or any other conditions beyond those indicated under "Recommended Operating Conditions" is not implied. Exposure to "Absolute Maximum Ratings" for extended periods may affect device reliability.

Note 2: Absolute maximum ratings indicate limits beyond which damage to the component may occur. Electrical specifications do not apply when operating the device outside of its operating ratings. The maximum allowable power dissipation is a function of the maximum junction temperature, $T_{J(max)}$, the junction-to-ambient thermal resistance, θ_{JA} , and the ambient temperature, T_A . The maximum allowable power dissipation at any ambient temperature is calculated using: $P_{D(max)} = (T_{J(max)} - T_A) / \theta_{JA}$. Exceeding the maximum allowable power dissipation will result in excessive die temperature.

Recommended Operating Conditions

| Parameter | Symbol | Min | Max | Unit |
|--------------------------------------|----------|-----|-----|------|
| Input Voltage | V_{IN} | 2 | 6 | V |
| Operating Junction Temperature Range | T_J | -40 | 85 | °C |



HIGH SPEED, EXTREMELY LOW NOISE LDO REGULATOR **AP2122**

Electrical Characteristics
AP2122-1.5 Electrical Characteristics

($V_{IN}=2.5V$, $T_J=25^{\circ}C$, $C_{IN}=1\mu F$, $C_{OUT}=1\mu F$, **Bold** typeface applies over $-40^{\circ}C \leq T_J \leq 85^{\circ}C$, unless otherwise specified.)

| Parameter | Symbol | Conditions | Min | Typ | Max | Unit |
|--|-------------------------------------|--|------|-----------------------------|------|-------------------|
| Output Voltage | V_{OUT} | $V_{IN}=2.5V$ $1mA \leq I_{OUT} \leq 30mA$ | 1.47 | 1.5 | 1.53 | V |
| Input Voltage | V_{IN} | | | | 6 | V |
| Output Current | I_{OUT} | $V_{IN}-V_{OUT}=1V$ | 150 | | | mA |
| Load Regulation | V_{RLOAD} | $V_{IN}=2.5V$ $1mA \leq I_{OUT} \leq 80mA$ | | 12 | 40 | mV |
| Line Regulation | V_{RLINE} | $2.3V \leq V_{IN} \leq 6V$ $I_{OUT}=30mA$ | | 4 | 16 | mV |
| Dropout Voltage | V_{DROP} | $I_{OUT}=10mA$ | | 400 | 600 | mV |
| | | $I_{OUT}=100mA$ | | 400 | 600 | |
| | | $I_{OUT}=150mA$ | | 400 | 600 | |
| Quiescent Current | I_Q | $V_{IN}=2.5V$, $I_{OUT}=0mA$ | | 25 | 50 | μA |
| Standby Current | I_{STD} | $V_{IN}=2.5V$ V_{CE} in OFF mode | | 0.1 | 1 | μA |
| Power Supply Rejection Ratio | PSRR | Ripple 0.5Vp-p, $f=10kHz$ $V_{IN}=2.5V$ | | 70 | | dB |
| Output Voltage Temperature Coefficient | $\Delta V_{OUT}/\Delta T$ | $I_{OUT}=30mA$ | | ± 150 | | $\mu V/^{\circ}C$ |
| | $(\Delta V_{OUT}/V_{OUT})/\Delta T$ | | | ± 100 | | ppm/ $^{\circ}C$ |
| Short Current Limit | I_{LIMIT} | $V_{OUT}=0V$ | | 50 | | mA |
| RMS Output Noise | V_{NOISE} | $T_A=25^{\circ}C$ $10Hz \leq f \leq 100kHz$ | | 30 | | μV_{rms} |
| CE "High" Voltage | | CE input voltage "High" | 1.5 | | | V |
| CE "Low" Voltage | | CE input voltage "Low" | | | 0.25 | V |
| CE Pull-down Internal Resistance | R_{PD} | | 2.5 | 5 | 10 | $M\Omega$ |
| Thermal Resistance (Junction to Case) | θ_{JC} | SOT-23-5 | | 73.9 | | $^{\circ}C/W$ |



HIGH SPEED, EXTREMELY LOW NOISE LDO REGULATOR

AP2122

Electrical Characteristics (Continued)

AP2122-1.8 Electrical Characteristics

($V_{IN}=2.8V$, $T_J=25^{\circ}C$, $C_{IN}=1\mu F$, $C_{OUT}=1\mu F$, **Bold** typeface applies over $-40^{\circ}C \leq T_J \leq 85^{\circ}C$, unless otherwise specified.)

| Parameter | Symbol | Conditions | Min | Typ | Max | Unit |
|--|-------------------------------------|--|-------|-----------------------------|-------|-------------------|
| Output Voltage | V_{OUT} | $V_{IN}=2.8V$ $1mA \leq I_{OUT} \leq 30mA$ | 1.764 | 1.8 | 1.836 | V |
| Input Voltage | V_{IN} | | | | 6 | V |
| Output Current | I_{OUT} | $V_{IN}-V_{OUT}=1V$ | 150 | | | mA |
| Load Regulation | V_{RLOAD} | $V_{IN}=2.8V$ $1mA \leq I_{OUT} \leq 80mA$ | | 12 | 40 | mV |
| Line Regulation | V_{RLINE} | $2.3V \leq V_{IN} \leq 6V$ $I_{OUT}=30mA$ | | 4 | 16 | mV |
| Dropout Voltage | V_{DROP} | $I_{OUT}=10mA$ | | 20 | 40 | mV |
| | | $I_{OUT}=100mA$ | | 150 | 300 | |
| | | $I_{OUT}=150mA$ | | 200 | 400 | |
| Quiescent Current | I_Q | $V_{IN}=2.8V$, $I_{OUT}=0mA$ | | 25 | 50 | μA |
| Standby Current | I_{STD} | $V_{IN}=2.8V$ V_{CE} in OFF mode | | 0.1 | 1 | μA |
| Power Supply Rejection Ratio | PSRR | Ripple 0.5Vp-p, $f=10kHz$ $V_{IN}=2.8V$ | | 70 | | dB |
| Output Voltage Temperature Coefficient | $\Delta V_{OUT}/\Delta T$ | $I_{OUT}=30mA$ | | ± 180 | | $\mu V/^{\circ}C$ |
| | $(\Delta V_{OUT}/V_{OUT})/\Delta T$ | | | ± 100 | | ppm/ $^{\circ}C$ |
| Short Current Limit | I_{LIMIT} | $V_{OUT}=0V$ | | 50 | | mA |
| RMS Output Noise | V_{NOISE} | $T_A=25^{\circ}C$ $10Hz \leq f \leq 100kHz$ | | 30 | | μV_{rms} |
| CE "High" Voltage | | CE input voltage "High" | 1.5 | | | V |
| CE "Low" Voltage | | CE input voltage "Low" | | | 0.25 | V |
| CE Pull-down Internal Resistance | R_{PD} | | 2.5 | 5 | 10 | $M\Omega$ |
| Thermal Resistance (Junction to Case) | θ_{JC} | SOT-23-5 | | 73.9 | | $^{\circ}C/W$ |



HIGH SPEED, EXTREMELY LOW NOISE LDO REGULATOR

AP2122

Electrical Characteristics (Continued)

AP2122-2.5 Electrical Characteristics

($V_{IN}=3.5V$, $T_J=25^{\circ}C$, $C_{IN}=1\mu F$, $C_{OUT}=1\mu F$, **Bold** typeface applies over $-40^{\circ}C \leq T_J \leq 85^{\circ}C$, unless otherwise specified.)

| Parameter | Symbol | Conditions | Min | Typ | Max | Unit |
|--|-------------------------------------|--|------|-----------------------------|------|-------------------|
| Output Voltage | V_{OUT} | $V_{IN}=3.5V$ $1mA \leq I_{OUT} \leq 30mA$ | 2.45 | 2.5 | 2.55 | V |
| Input Voltage | V_{IN} | | | | 6 | V |
| Output Current | I_{OUT} | $V_{IN}-V_{OUT}=1V$ | 150 | | | mA |
| Load Regulation | V_{RLOAD} | $V_{IN}=3.5V$ $1mA \leq I_{OUT} \leq 80mA$ | | 12 | 40 | mV |
| Line Regulation | V_{RLINE} | $3V \leq V_{IN} \leq 6V$ $I_{OUT}=30mA$ | | 4 | 16 | mV |
| Dropout Voltage | V_{DROP} | $I_{OUT}=10mA$ | | 20 | 40 | mV |
| | | $I_{OUT}=100mA$ | | 150 | 300 | |
| | | $I_{OUT}=150mA$ | | 200 | 400 | |
| Quiescent Current | I_Q | $V_{IN}=3.5V$, $I_{OUT}=0mA$ | | 25 | 50 | μA |
| Standby Current | I_{STD} | $V_{IN}=3.5V$ V_{CE} in OFF mode | | 0.1 | 1 | μA |
| Power Supply Rejection Ratio | PSRR | Ripple 0.5Vp-p, $f=10kHz$ $V_{IN}=3.5V$ | | 70 | | dB |
| Output Voltage Temperature Coefficient | $\Delta V_{OUT}/\Delta T$ | $I_{OUT}=30mA$ | | ± 250 | | $\mu V/^{\circ}C$ |
| | $(\Delta V_{OUT}/V_{OUT})/\Delta T$ | | | ± 100 | | ppm/ $^{\circ}C$ |
| Short Current Limit | I_{LIMIT} | $V_{OUT}=0V$ | | 50 | | mA |
| RMS Output Noise | V_{NOISE} | $T_A=25^{\circ}C$ $10Hz \leq f \leq 100kHz$ | | 30 | | μV_{rms} |
| CE "High" Voltage | | CE input voltage "High" | 1.5 | | | V |
| CE "Low" Voltage | | CE input voltage "Low" | | | 0.25 | V |
| CE Pull-down Internal Resistance | R_{PD} | | 2.5 | 5 | 10 | $M\Omega$ |
| Thermal Resistance (Junction to Case) | θ_{JC} | SOT-23-5 | | 73.9 | | $^{\circ}C/W$ |



HIGH SPEED, EXTREMELY LOW NOISE LDO REGULATOR

AP2122

Electrical Characteristics (Continued)

AP2122-2.8 Electrical Characteristics

($V_{IN}=3.8V$, $T_J=25^{\circ}C$, $C_{IN}=1\mu F$, $C_{OUT}=1\mu F$, **Bold** typeface applies over $-40^{\circ}C \leq T_J \leq 85^{\circ}C$, unless otherwise specified.)

| Parameter | Symbol | Conditions | Min | Typ | Max | Unit |
|--|-------------------------------------|--|-------|-----------------------------|-------|-------------------|
| Output Voltage | V_{OUT} | $V_{IN}=3.8V$ $1mA \leq I_{OUT} \leq 30mA$ | 2.744 | 2.8 | 2.856 | V |
| Input Voltage | V_{IN} | | | | 6 | V |
| Output Current | I_{OUT} | $V_{IN}-V_{OUT}=1V$ | 150 | | | mA |
| Load Regulation | V_{RLOAD} | $V_{IN}=3.8V$ $1mA \leq I_{OUT} \leq 80mA$ | | 12 | 40 | mV |
| Line Regulation | V_{RLINE} | $3.3V \leq V_{IN} \leq 6V$ $I_{OUT}=30mA$ | | 4 | 16 | mV |
| Dropout Voltage | V_{DROP} | $I_{OUT}=10mA$ | | 20 | 40 | mV |
| | | $I_{OUT}=100mA$ | | 150 | 300 | |
| | | $I_{OUT}=150mA$ | | 200 | 400 | |
| Quiescent Current | I_Q | $V_{IN}=3.8V$, $I_{OUT}=0mA$ | | 25 | 50 | μA |
| Standby Current | I_{STD} | $V_{IN}=3.8V$ V_{CE} in OFF mode | | 0.1 | 1 | μA |
| Power Supply Rejection Ratio | PSRR | Ripple 0.5Vp-p, $f=10kHz$ $V_{IN}=3.8V$ | | 70 | | dB |
| Output Voltage Temperature Coefficient | $\Delta V_{OUT}/\Delta T$ | $I_{OUT}=30mA$ | | ± 280 | | $\mu V/^{\circ}C$ |
| | $(\Delta V_{OUT}/V_{OUT})/\Delta T$ | | | ± 100 | | ppm/ $^{\circ}C$ |
| Short Current Limit | I_{LIMIT} | $V_{OUT}=0V$ | | 50 | | mA |
| RMS Output Noise | V_{NOISE} | $T_A=25^{\circ}C$ $10Hz \leq f \leq 100kHz$ | | 30 | | μV_{rms} |
| CE "High" Voltage | | CE input voltage "High" | 1.5 | | | V |
| CE "Low" Voltage | | CE input voltage "Low" | | | 0.25 | V |
| CE Pull-down Internal Resistance | R_{PD} | | 2.5 | 5 | 10 | $M\Omega$ |
| Thermal Resistance (Junction to Case) | θ_{JC} | SOT-23-5 | | 73.9 | | $^{\circ}C/W$ |



HIGH SPEED, EXTREMELY LOW NOISE LDO REGULATOR **AP2122**

Electrical Characteristics (Continued)

AP2122-3.0 Electrical Characteristics

($V_{IN}=4V$, $T_J=25^{\circ}C$, $C_{IN}=1\mu F$, $C_{OUT}=1\mu F$, **Bold** typeface applies over $-40^{\circ}C \leq T_J \leq 85^{\circ}C$, unless otherwise specified.)

| Parameter | Symbol | Conditions | Min | Typ | Max | Unit |
|--|-------------------------------------|--|------|-----------------------------|------|-------------------|
| Output Voltage | V_{OUT} | $V_{IN}=4V$ $1mA \leq I_{OUT} \leq 30mA$ | 2.94 | 3.0 | 3.06 | V |
| Input Voltage | V_{IN} | | | | 6 | V |
| Output Current | I_{OUT} | $V_{IN}-V_{OUT}=1V$ | 150 | | | mA |
| Load Regulation | V_{RLOAD} | $V_{IN}=4V$ $1mA \leq I_{OUT} \leq 80mA$ | | 12 | 40 | mV |
| Line Regulation | V_{RLINE} | $3.5V \leq V_{IN} \leq 6V$ $I_{OUT}=30mA$ | | 4 | 16 | mV |
| Dropout Voltage | V_{DROP} | $I_{OUT}=10mA$ | | 20 | 40 | mV |
| | | $I_{OUT}=100mA$ | | 150 | 300 | |
| | | $I_{OUT}=150mA$ | | 200 | 400 | |
| Quiescent Current | I_Q | $V_{IN}=4V$, $I_{OUT}=0mA$ | | 25 | 50 | μA |
| Standby Current | I_{STD} | $V_{IN}=4V$ V_{CE} in OFF mode | | 0.1 | 1 | μA |
| Power Supply Rejection Ratio | PSRR | Ripple 0.5Vp-p, $f=10kHz$ $V_{IN}=4V$ | | 70 | | dB |
| Output Voltage Temperature Coefficient | $\Delta V_{OUT}/\Delta T$ | $I_{OUT}=30mA$ | | ± 300 | | $\mu V/^{\circ}C$ |
| | $(\Delta V_{OUT}/V_{OUT})/\Delta T$ | | | ± 100 | | ppm/ $^{\circ}C$ |
| Short Current Limit | I_{LIMIT} | $V_{OUT}=0V$ | | 50 | | mA |
| RMS Output Noise | V_{NOISE} | $T_A=25^{\circ}C$ $10Hz \leq f \leq 100kHz$ | | 30 | | μV_{rms} |
| CE "High" Voltage | | CE input voltage "High" | 1.5 | | | V |
| CE "Low" Voltage | | CE input voltage "Low" | | | 0.25 | V |
| CE Pull-down Internal Resistance | R_{PD} | | 2.5 | 5 | 10 | $M\Omega$ |
| Thermal Resistance (Junction to Case) | θ_{JC} | SOT-23-5 | | 73.9 | | $^{\circ}C/W$ |



HIGH SPEED, EXTREMELY LOW NOISE LDO REGULATOR

AP2122

Electrical Characteristics (Continued)

AP2122-3.2 Electrical Characteristics

($V_{IN}=4.2V$, $T_J=25^{\circ}C$, $C_{IN}=1\mu F$, $C_{OUT}=1\mu F$, **Bold** typeface applies over $-40^{\circ}C \leq T_J \leq 85^{\circ}C$, unless otherwise specified.)

| Parameter | Symbol | Conditions | Min | Typ | Max | Unit |
|--|-------------------------------------|--|-------|-----------------------------|-------|-------------------|
| Output Voltage | V_{OUT} | $V_{IN}=4.2V$ $1mA \leq I_{OUT} \leq 30mA$ | 3.136 | 3.2 | 3.264 | V |
| Input Voltage | V_{IN} | | | | 6 | V |
| Output Current | I_{OUT} | $V_{IN}-V_{OUT}=1V$ | 150 | | | mA |
| Load Regulation | V_{RLOAD} | $V_{IN}=4.2V$ $1mA \leq I_{OUT} \leq 80mA$ | | 12 | 40 | mV |
| Line Regulation | V_{RLINE} | $3.7V \leq V_{IN} \leq 6V$ $I_{OUT}=30mA$ | | 4 | 16 | mV |
| Dropout Voltage | V_{DROP} | $I_{OUT}=10mA$ | | 20 | 40 | mV |
| | | $I_{OUT}=100mA$ | | 150 | 300 | |
| | | $I_{OUT}=150mA$ | | 200 | 400 | |
| Quiescent Current | I_Q | $V_{IN}=4.2V$, $I_{OUT}=0mA$ | | 25 | 50 | μA |
| Standby Current | I_{STD} | $V_{IN}=4.2V$ V_{CE} in OFF mode | | 0.1 | 1 | μA |
| Power Supply Rejection Ratio | PSRR | Ripple 0.5Vp-p, $f=10kHz$ $V_{IN}=4.2V$ | | 70 | | dB |
| Output Voltage Temperature Coefficient | $\Delta V_{OUT}/\Delta T$ | $I_{OUT}=30mA$ | | ± 320 | | $\mu V/^{\circ}C$ |
| | $(\Delta V_{OUT}/V_{OUT})/\Delta T$ | | | ± 100 | | ppm/ $^{\circ}C$ |
| Short Current Limit | I_{LIMIT} | $V_{OUT}=0V$ | | 50 | | mA |
| RMS Output Noise | V_{NOISE} | $T_A=25^{\circ}C$ $10Hz \leq f \leq 100kHz$ | | 30 | | μV_{rms} |
| CE "High" Voltage | | CE input voltage "High" | 1.5 | | | V |
| CE "Low" Voltage | | CE input voltage "Low" | | | 0.25 | V |
| CE Pull-down Internal Resistance | R_{PD} | | 2.5 | 5 | 10 | $M\Omega$ |
| Thermal Resistance (Junction to Case) | θ_{JC} | SOT-23-5 | | 73.9 | | $^{\circ}C/W$ |



HIGH SPEED, EXTREMELY LOW NOISE LDO REGULATOR

AP2122

Electrical Characteristics (Continued)

AP2122-3.3 Electrical Characteristics

($V_{IN}=4.3V$, $T_J=25^{\circ}C$, $C_{IN}=1\mu F$, $C_{OUT}=1\mu F$, **Bold** typeface applies over $-40^{\circ}C \leq T_J \leq 85^{\circ}C$, unless otherwise specified.)

| Parameter | Symbol | Conditions | Min | Typ | Max | Unit |
|--|-------------------------------------|--|-------|-----------------------------|-------|-------------------|
| Output Voltage | V_{OUT} | $V_{IN}=4.3V$ $1mA \leq I_{OUT} \leq 30mA$ | 3.234 | 3.3 | 3.366 | V |
| Input Voltage | V_{IN} | | | | 6 | V |
| Output Current | I_{OUT} | $V_{IN}-V_{OUT}=1V$ | 150 | | | mA |
| Load Regulation | V_{RLOAD} | $V_{IN}=4.3V$ $1mA \leq I_{OUT} \leq 80mA$ | | 12 | 40 | mV |
| Line Regulation | V_{RLINE} | $3.8V \leq V_{IN} \leq 6V$ $I_{OUT}=30mA$ | | 4 | 16 | mV |
| Dropout Voltage | V_{DROP} | $I_{OUT}=10mA$ | | 20 | 40 | mV |
| | | $I_{OUT}=100mA$ | | 150 | 300 | |
| | | $I_{OUT}=150mA$ | | 200 | 400 | |
| Quiescent Current | I_Q | $V_{IN}=4.3V$, $I_{OUT}=0mA$ | | 25 | 50 | μA |
| Standby Current | I_{STD} | $V_{IN}=4.3V$ V_{CE} in OFF mode | | 0.1 | 1 | μA |
| Power Supply Rejection Ratio | PSRR | Ripple 0.5Vp-p, $f=10kHz$ $V_{IN}=4.3V$ | | 70 | | dB |
| Output Voltage Temperature Coefficient | $\Delta V_{OUT}/\Delta T$ | $I_{OUT}=30mA$ | | ± 330 | | $\mu V/^{\circ}C$ |
| | $(\Delta V_{OUT}/V_{OUT})/\Delta T$ | | | ± 100 | | ppm/ $^{\circ}C$ |
| Short Current Limit | I_{LIMIT} | $V_{OUT}=0V$ | | 50 | | mA |
| RMS Output Noise | V_{NOISE} | $T_A=25^{\circ}C$ $10Hz \leq f \leq 100kHz$ | | 30 | | μV_{rms} |
| CE "High" Voltage | | CE input voltage "High" | 1.5 | | | V |
| CE "Low" Voltage | | CE input voltage "Low" | | | 0.25 | V |
| CE Pull-down Internal Resistance | R_{PD} | | 2.5 | 5 | 10 | $M\Omega$ |
| Thermal Resistance (Junction to Case) | θ_{JC} | SOT-23-5 | | 73.9 | | $^{\circ}C/W$ |



HIGH SPEED, EXTREMELY LOW NOISE LDO REGULATOR

AP2122

Typical Performance Characteristics

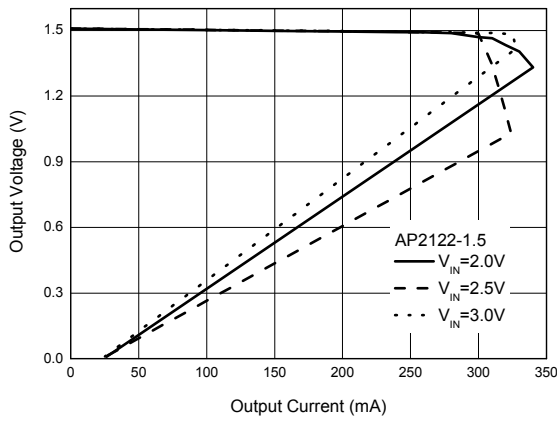

Figure 4. Output Voltage vs. Output Current

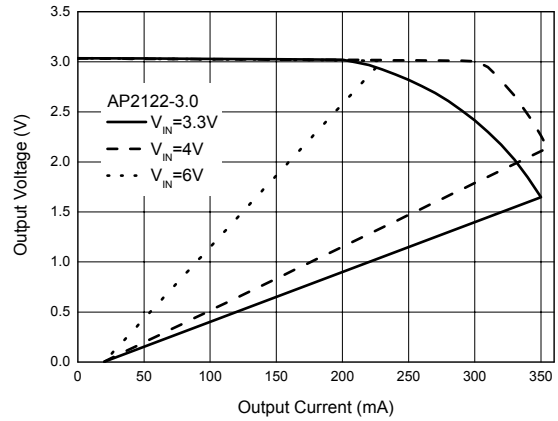

Figure 5. Output Voltage vs. Output Current

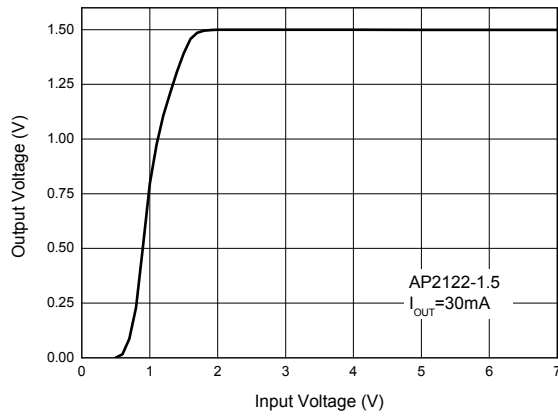

Figure 6. Output Voltage vs. Input Voltage

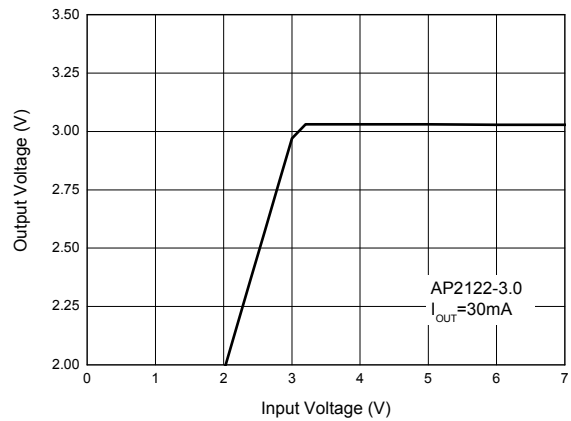

Figure 7. Output Voltage vs. Input Voltage



HIGH SPEED, EXTREMELY LOW NOISE LDO REGULATOR

AP2122

Typical Performance Characteristics (Continued)

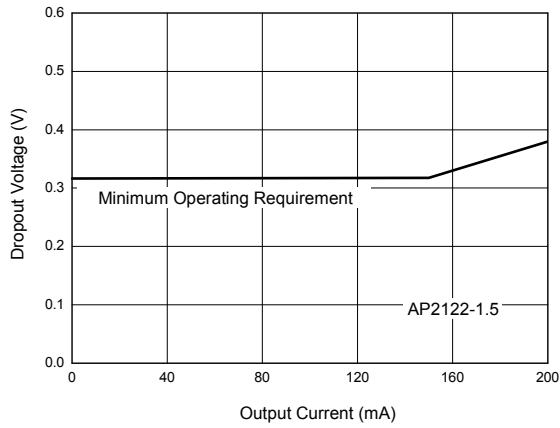

Figure 8. Dropout Voltage vs. Output Current

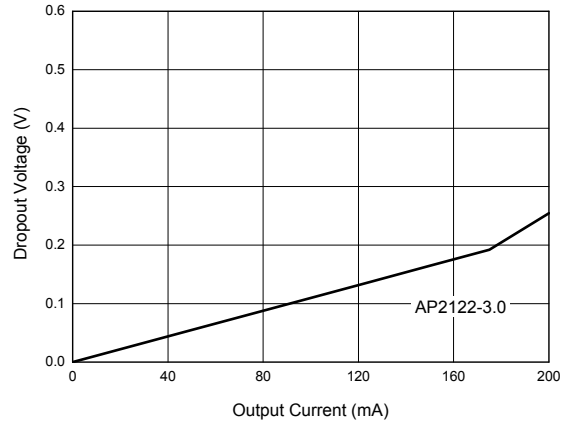

Figure 9. Dropout Voltage vs. Output Current

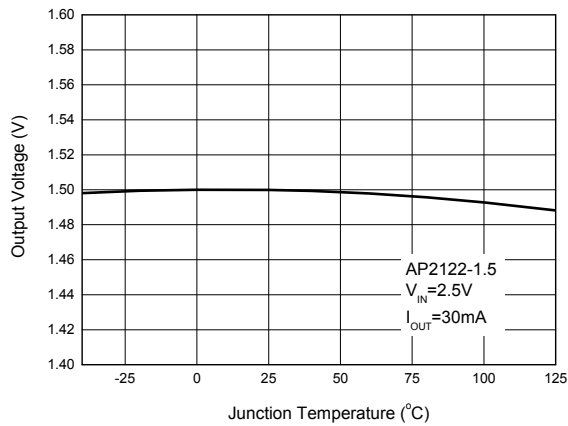

Figure 10. Output Voltage vs. Junction Temperature

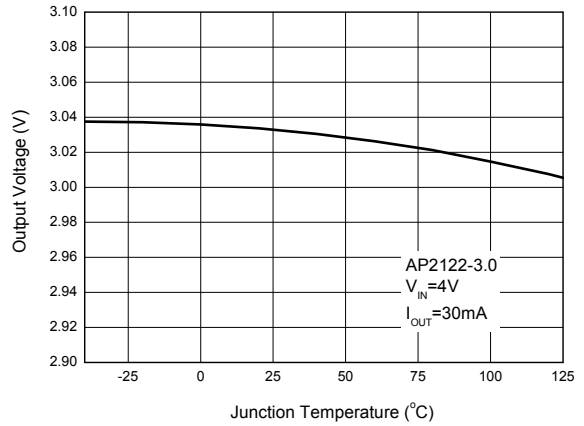

Figure 11. Output Voltage vs. Junction Temperature



HIGH SPEED, EXTREMELY LOW NOISE LDO REGULATOR

AP2122

Typical Performance Characteristics (Continued)

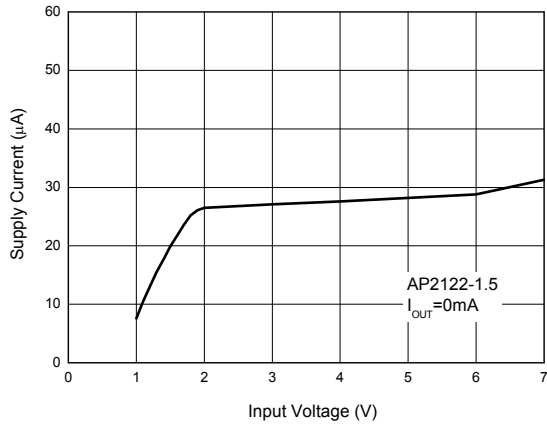

Figure 12. Supply Current vs. Input Voltage

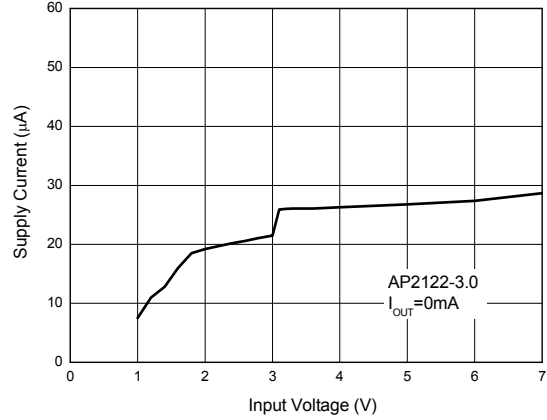

Figure 13. Supply Current vs. Input Voltage

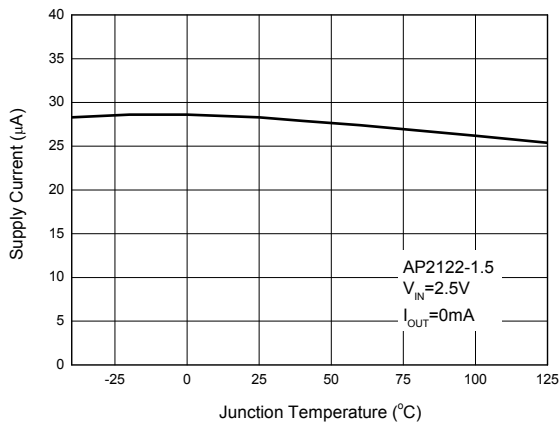

Figure 14. Supply Current vs. Junction Temperature

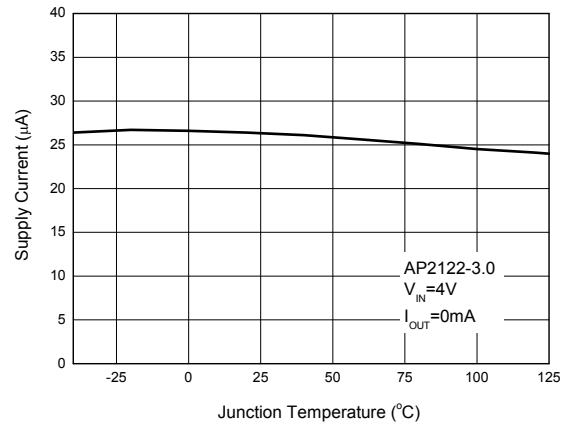

Figure 15. Supply Current vs. Junction Temperature

Typical Performance Characteristics (Continued)

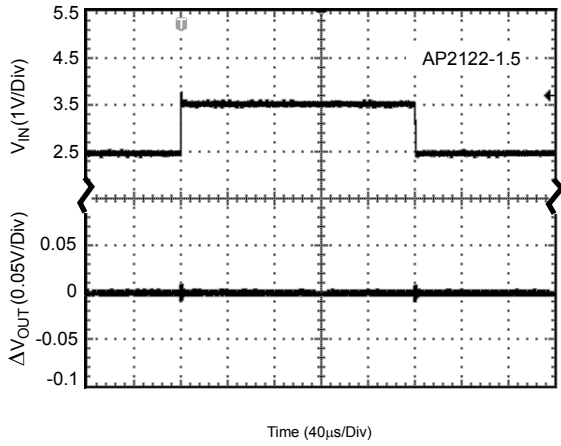

Figure 16. Line Transient
(Conditions: $I_{OUT}=30\text{mA}$, $C_{IN}=1\mu\text{F}$, $C_{OUT}=1\mu\text{F}$)

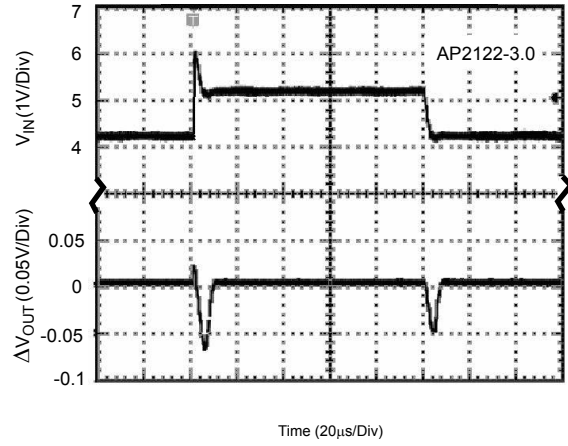

Figure 17. Line Transient
(Conditions: $I_{OUT}=30\text{mA}$, $C_{IN}=1\mu\text{F}$, $C_{OUT}=1\mu\text{F}$)

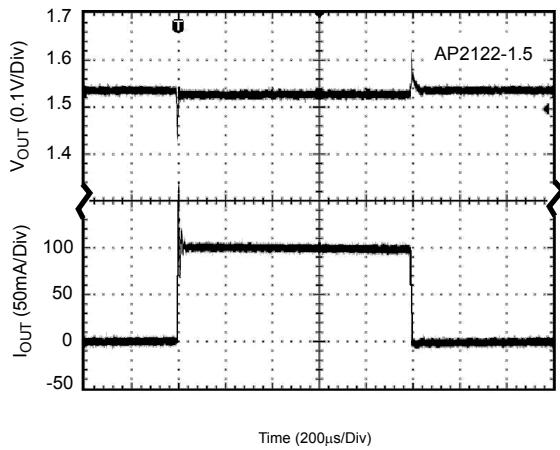

Figure 18. Load Transient
(Conditions: $V_{IN}=2.5\text{V}$, $C_{IN}=1\mu\text{F}$, $C_{OUT}=1\mu\text{F}$)

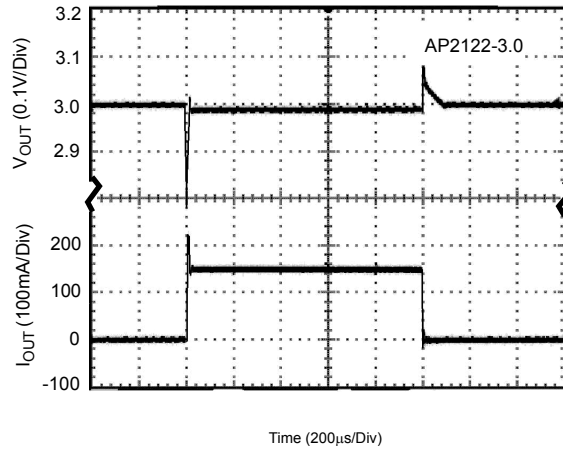

Figure 19. Load Transient
(Conditions: $V_{IN}=4\text{V}$, $C_{IN}=1\mu\text{F}$, $C_{OUT}=1\mu\text{F}$)



Typical Performance Characteristics (Continued)

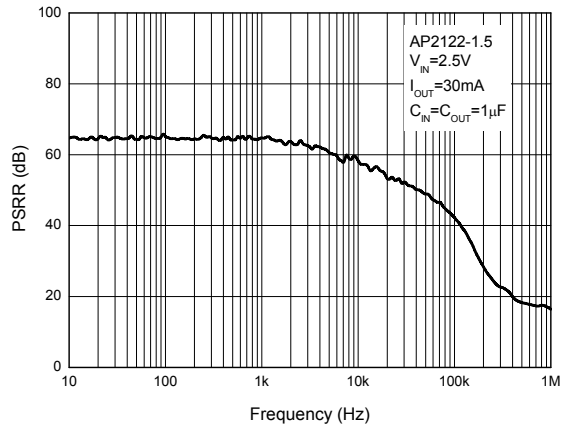

Figure 20. PSRR vs. Frequency

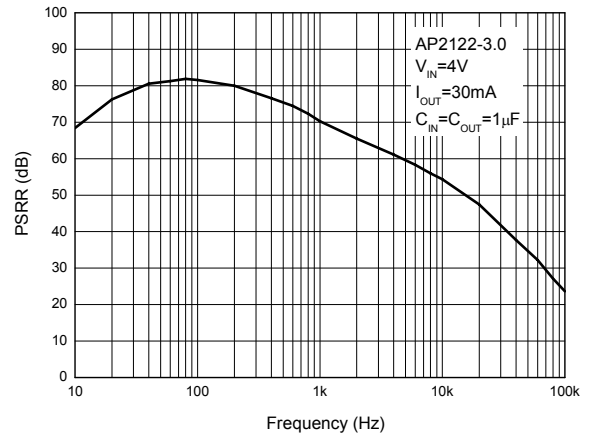
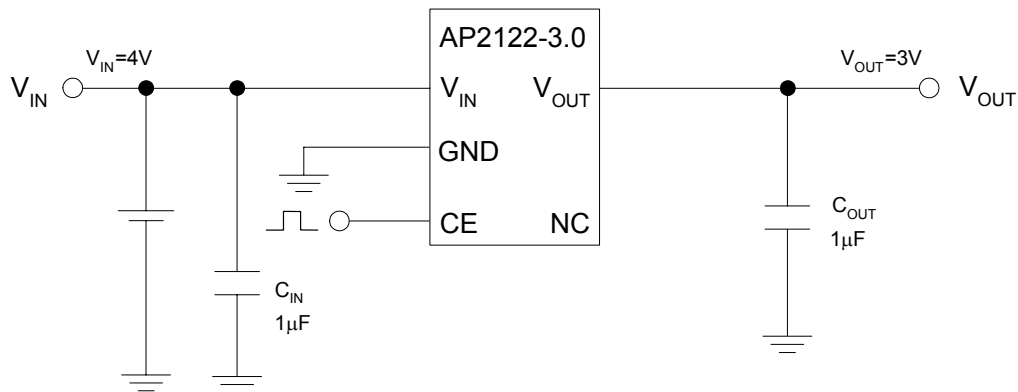

Figure 21. PSRR vs. Frequency

Typical Application

Note: Filter capacitors are required at the AP2122's input and output. $1\mu\text{F}$ capacitor is required at the input. The minimum output capacitance required for stability should be more than $1\mu\text{F}$ with ESR from 0.01Ω to 100Ω . Ceramic capacitors are recommended.

Figure 22. Typical Application of AP2122



HIGH SPEED, EXTREMELY LOW NOISE LDO REGULATOR

AP2122

Mechanical Dimensions

SOT-23-5

Unit: mm(inch)

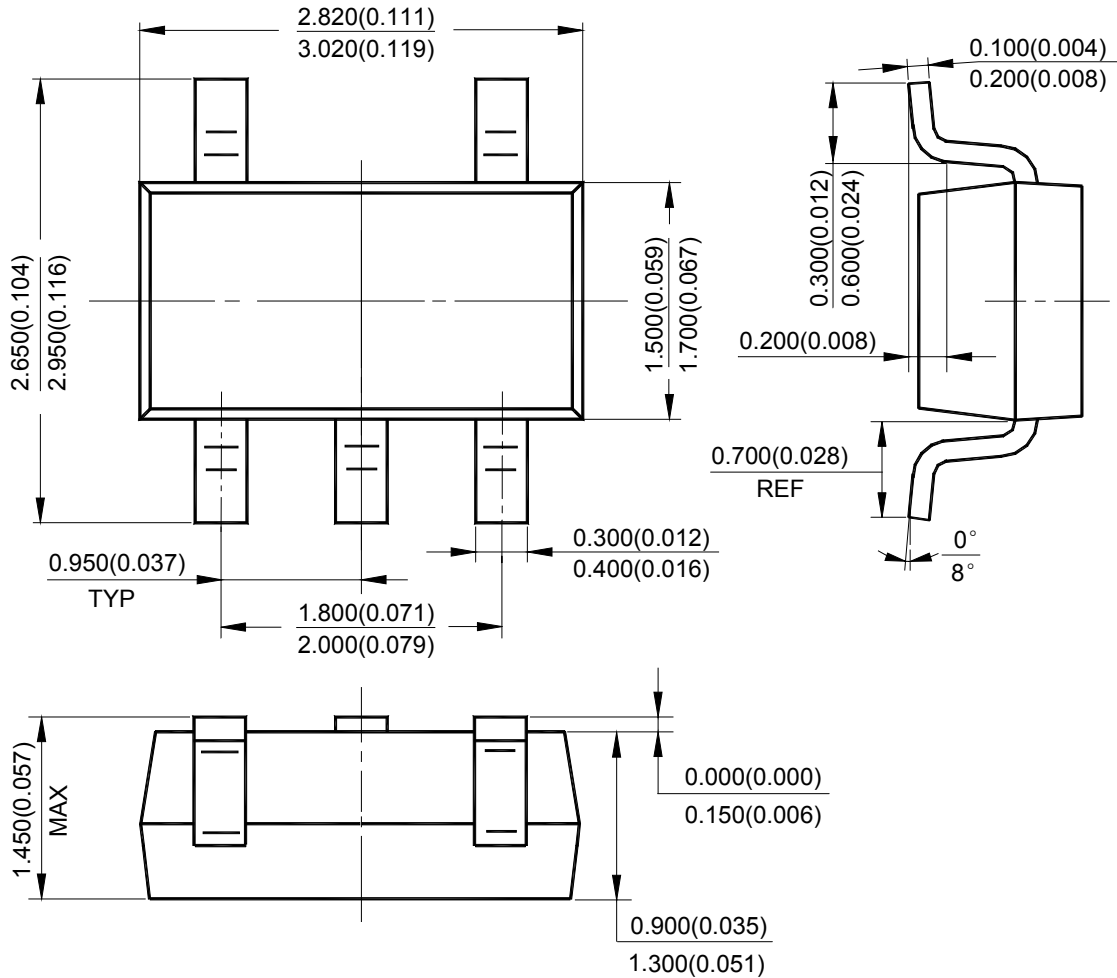



BCD Semiconductor Manufacturing Limited

<http://www.bcdsemi.com>

IMPORTANT NOTICE

BCD Semiconductor Manufacturing Limited reserves the right to make changes without further notice to any products or specifications herein. BCD Semiconductor Manufacturing Limited does not assume any responsibility for use of any its products for any particular purpose, nor does BCD Semiconductor Manufacturing Limited assume any liability arising out of the application or use of any its products or circuits. BCD Semiconductor Manufacturing Limited does not convey any license under its patent rights or other rights nor the rights of others.

MAIN SITE

- Headquarters

BCD Semiconductor Manufacturing Limited

No. 1600, Zi Xing Road, Shanghai Zizhu Science-based Industrial Park, 200241, China
Tel: +86-21-24162266, Fax: +86-21-24162277

- Wafer Fab

Shanghai SIM-BCD Semiconductor Manufacturing Co., Ltd.

800 Yi Shan Road, Shanghai 200233, China
Tel: +86-21-6485 1491, Fax: +86-21-5450 0008

REGIONAL SALES OFFICE

Shenzhen Office

Shanghai SIM-BCD Semiconductor Manufacturing Co., Ltd., Shenzhen Office

Unit A Room 1203, Skyworth Bldg., Gaoxin Ave. 1.S., Nanshan District, Shenzhen, China
Tel: +86-755-8826 7951
Fax: +86-755-8826 7865

Taiwan Office

BCD Semiconductor (Taiwan) Company Limited

4F, 298-1, Rui Guang Road, Nei-Hu District, Taipei, Taiwan
Tel: +886-2-2656 2808
Fax: +886-2-2656 2806

USA Office

BCD Semiconductor Corp.

30920 Huntwood Ave. Hayward, CA 94544, USA
Tel : +1-510-324-2988
Fax: +1-510-324-2788