

C/A-508X ALPHA-NUMERIC DISPLAY

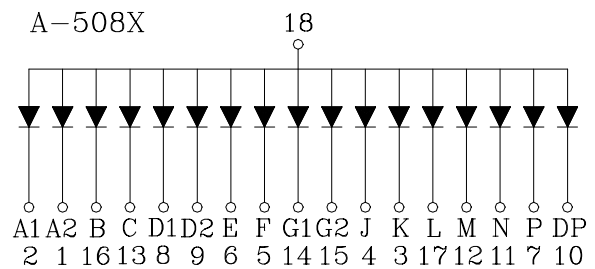
Shape	Part No.		Chip		Wave Length λ_p (nm)	Electro-Optical Characteristics			Fig. No.
	Common Cathode	Common Anode	Raw Material	Emitted Color		Vf(V)20mA		Iv(ucd)10mA	
						Typ.	Max.	Typ.	
	C-508H	A-508H	GaP	Red	700	2.1	2.8	650	D56
	C-508E	A-508E	GaAsP/GaP	Hi. effi Red	635	2.0	2.8	2000	
	C-508G	A-508G	GaP	Green	565	2.1	2.8	2000	
	C-508Y	A-508Y	GaAsP/GaP	Yellow	585	2.1	2.8	1600	
	C-508SR	A-508SR	GaAlAs	Super Red	660	1.8	2.4	10000	

Fig.D56

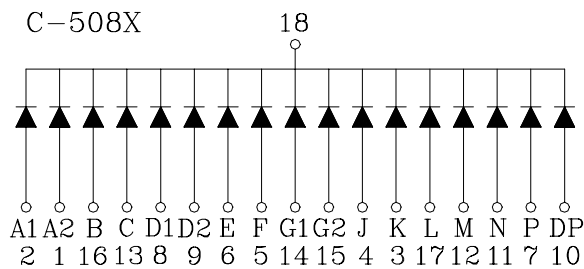
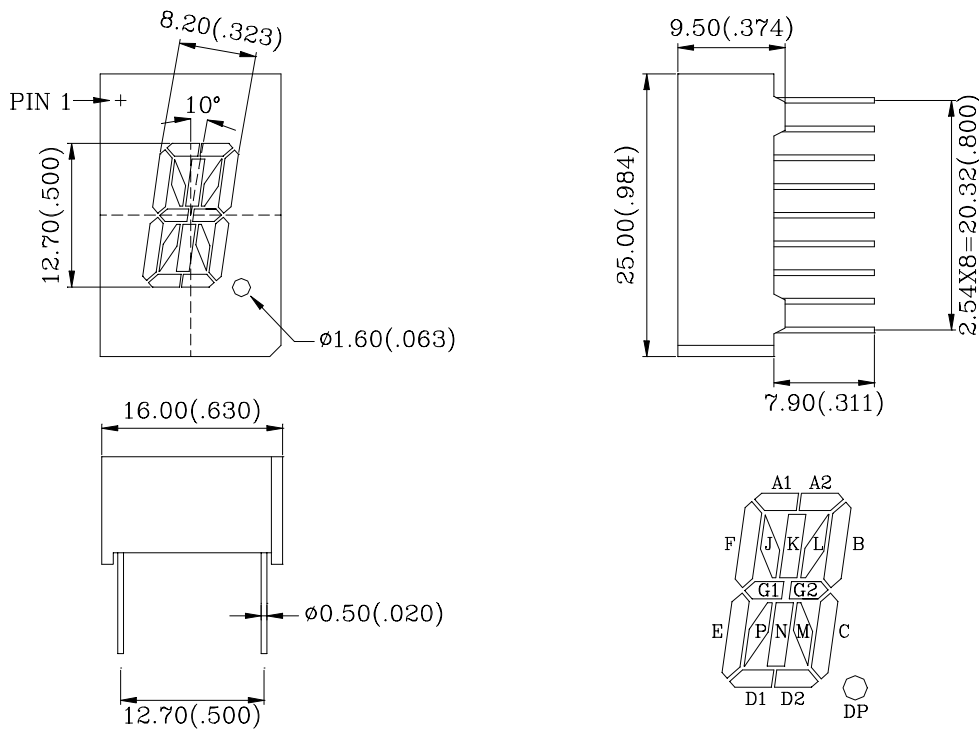

- 1.All dimension are in millimeters (inches).
- 2.Tolerance is ± 0.25 mm (0.01") unless otherwise specified.