

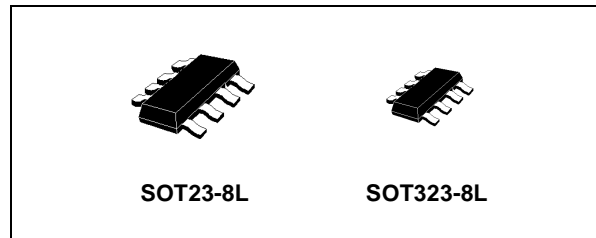

74V2T384

DUAL HIGH SPEED BUS SWITCH

- HIGH SPEED: $t_{PD} = 0.5ns$ (TYP.) at $V_{CC} = 5V$
- COMPATIBLE WITH TTL LEVEL
- LOW POWER DISSIPATION:
 $I_{CC} = 1\mu A$ (MAX.) at $T_A=25^\circ C$
- LOW "ON" RESISTANCE at $V_{CC}=5.0V$:
 $R_{ON} = 7\Omega$ (TYP.) $V_{IN} = 0V$ $I_{I/O} = 30mA$
 $R_{ON} = 20\Omega$ (TYP.) $V_{IN} = 2.4V$ $I_{I/O} = 10mA$
- OPERATING VOLTAGE RANGE:
 V_{CC} (OPR) = 4.0V TO 5.5V
- 5V TOLERANT ON CONTROL PIN
- IMPROVED LATCH-UP IMMUNITY



DESCRIPTION

The 74V2T384 is an advanced high-speed CMOS DUAL HIGH SPEED BUS SWITCH fabricated in silicon gate C²MOS technology. It's designed to operate from 4.5V to 5.5V, making this device ideal for portable applications. It's offers 7Ω Resistance typical value at $V_{CC}=4.5V$. Additional key feature are fast switching speed ($t_{ON}=3.8ns$, $t_{OFF}=3.3ns$ Typical) and Low Power Consumption.

ORDER CODES

PACKAGE	T & R
SOT23-8L	74V2T384STR
SOT323-8L	74V2T384CTR

The \overline{OE} input is provided to control the switch; the switch is ON when the \overline{OE} input is held low and OFF when \overline{OE} is held high.

It's available in the commercial and extended temperature range in SOT23-8L and SOT323-8L package.

PIN CONNECTION AND IEC LOGIC SYMBOLS

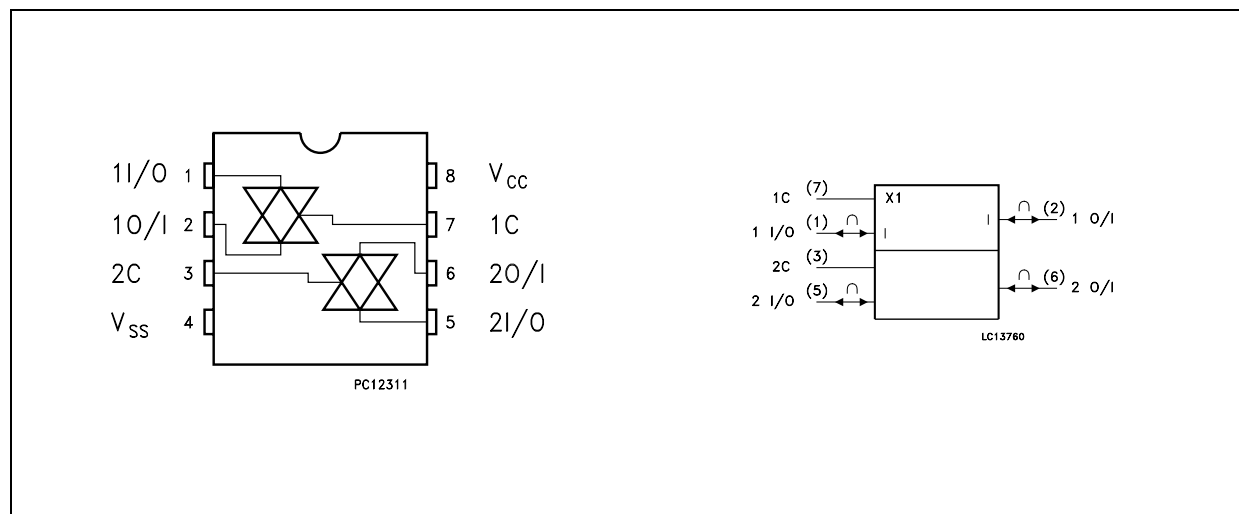

INPUT EQUIVALENT CIRCUIT

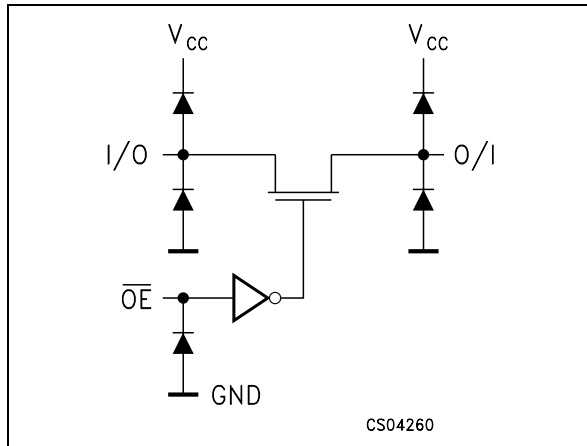

PIN DESCRIPTION

PIN No	SYMBOL	NAME AND FUNCTION
1, 5	1I/O, 2I/O	Independent Input/Output
2, 6	1O/I, 2O/I	Independent Output/Input
7, 3	$\overline{1OE}$, $\overline{2OE}$	Enable Input (Active HIGH)
4	GND	Ground (0V)
8	V_{CC}	Positive Supply Voltage

TRUTH TABLE

\overline{OE}	SWITCH FUNCTION
L	ON
H	OFF *

* High Impedance State

ABSOLUTE MAXIMUM RATINGS

Symbol	Parameter	Value	Unit
V_{CC}	Supply Voltage	-0.5 to +7.0	V
V_I	DC Input Voltage	-0.5 to $V_{CC} + 0.5$	V
V_{IC}	DC Control Input Voltage	-0.5 to +7.0	V
V_O	DC Output Voltage	-0.5 to $V_{CC} + 0.5$	V
I_{IK}	DC Input Diode Current	± 20	mA
I_{IK}	DC Control Input Diode Current	- 20	mA
I_{OK}	DC Output Diode Current	± 20	mA
I_O	DC Output Current	± 50	mA
I_{CC} or I_{GND}	DC V_{CC} or Ground Current	± 50	mA
T_{stg}	Storage Temperature	-65 to +150	$^{\circ}C$
T_L	Lead Temperature (10 sec)	300	$^{\circ}C$

Absolute Maximum Ratings are those values beyond which damage to the device may occur. Functional operation under these conditions is not implied.

RECOMMENDED OPERATING CONDITIONS

Symbol	Parameter	Value	Unit
V_{CC}	Supply Voltage	4.0 to 5.5	V
V_I	Input Voltage	0 to V_{CC}	V
V_{IC}	Control Input Voltage	0 to 5.5	V
V_O	Output Voltage	0 to V_{CC}	V
T_{op}	Operating Temperature	-55 to 125	$^{\circ}C$
dt/dv	Input Rise and Fall Time (note 1) $V_{CC} = 5.0V$	0 to 20	ns/V

1) V_{IN} from 0.8V to 2V on control pin

DC SPECIFICATIONS

Symbol	Parameter	Test Condition		Value						Unit	
		V _{CC} (V)		T _A = 25°C			-40 to 85°C		-55 to 125°C		
				Min.	Typ.	Max.	Min.	Max.	Min.		Max.
V _{IH}	High Level Input Voltage	5.0(*)		2			2		2		V
V _{IL}	Low Level Input Voltage	5.0(*)				0.8		0.8		0.8	V
V _{IH}	High Level Input Voltage	4.0		2			2		2		V
V _{IL}	Low Level Input Voltage	4.0				0.8		0.8		0.8	V
R _{ON}	ON Resistance	4.5	V _{IC} = V _{IL} V _{I/O} = GND I _{I/O} ≤ 30mA		7			10		15	V
R _{ON}	ON Resistance	4.5	V _{IC} = V _{IL} V _{I/O} = 2.4V I _{I/O} ≤ 10mA		20			40		60	V
I _{OFF}	Input/Output Leakage Current (SWITCH OFF)	5.5	V _{OS} = V _{CC} to GND V _{IS} = V _{CC} to GND V _{IC} = V _{IH}			±0.1		± 1		± 10	μA
I _{IN}	Control Input Leakage Current	0 to 5.5	V _{IC} = 5.5V or GND			± 0.1		± 1.0		± 1.0	μA
I _{CC}	Quiescent Supply Current	5.5	V _I = V _{CC} or GND			1		10		20	μA
ΔI _{CC}	Increase Quiescent Supply Current per Control Input	5.5	V _{IC} = V _{CC} -2.1V other V _{IC} = V _{CC} or GND			1.35		2.5		3.5	mA

AC ELECTRICAL CHARACTERISTICS (C_L = 50pF, Input t_r = t_f = 3ns)

Symbol	Parameter	Test Condition		Value						Unit	
		V _{CC} (V)		T _A = 25°C			-40 to 85°C		-55 to 125°C		
				Min.	Typ.	Max.	Min.	Max.	Min.		Max.
t _{PD}	Delay Time	5.0(*)	t _r = t _f = 6ns		0.5	0.8		1.0		1.5	ns
t _{PLZ} t _{PHZ}	Output Disable Time	5.0(*)	R _L = 500 Ω V _{IN} = 2.4V		3.8	6.5		9.0		10.0	ns
t _{PZL} t _{PZH}	Output Enable Time	5.0(*)	R _L = 1 KΩ V _{IN} = 2.4V		3.3	5.0		7.5		8.5	ns

(*) Voltage range is 5.0V ± 0.5V

CAPACITIVE CHARACTERISTICS

Symbol	Parameter	Test Condition	Value						Unit	
			T _A = 25°C			-40 to 85°C		-55 to 125°C		
			Min.	Typ.	Max.	Min.	Max.	Min.		Max.
C _{IN}	Input Capacitance			4	10		10		10	pF
C _{I/O}	Output Capacitance			7						pF
C _{PD}	Power Dissipation Capacitance (note 1)			3						pF

1) C_{PD} is defined as the value of the IC's internal equivalent capacitance which is calculated from the operating current consumption without load. (Refer to Test Circuit). Average operating current can be obtained by the following equation. $I_{CC(oper)} = C_{PD} \times V_{CC} \times f_{IN} + I_{CC}/2$ (per switch)

SOT23-8L MECHANICAL DATA

DIM.	mm.			mils		
	MIN.	TYP	MAX.	MIN.	TYP.	MAX.
A	0.90		1.45	35.4		57.1
A1	0.00		0.15	0.0		5.9
A2	0.90		1.30	35.4		51.2
b	0.22		0.38	8.6		14.9
C	0.09		0.20	3.5		7.8
D	2.80		3.00	110.2		118.1
E	2.60		3.00	102.3		118.1
E1	1.50		1.75	59.0		68.8
e	0	.65			25.6	
e1		1.95			76.7	
L	0.35		0.55	13.7		21.6

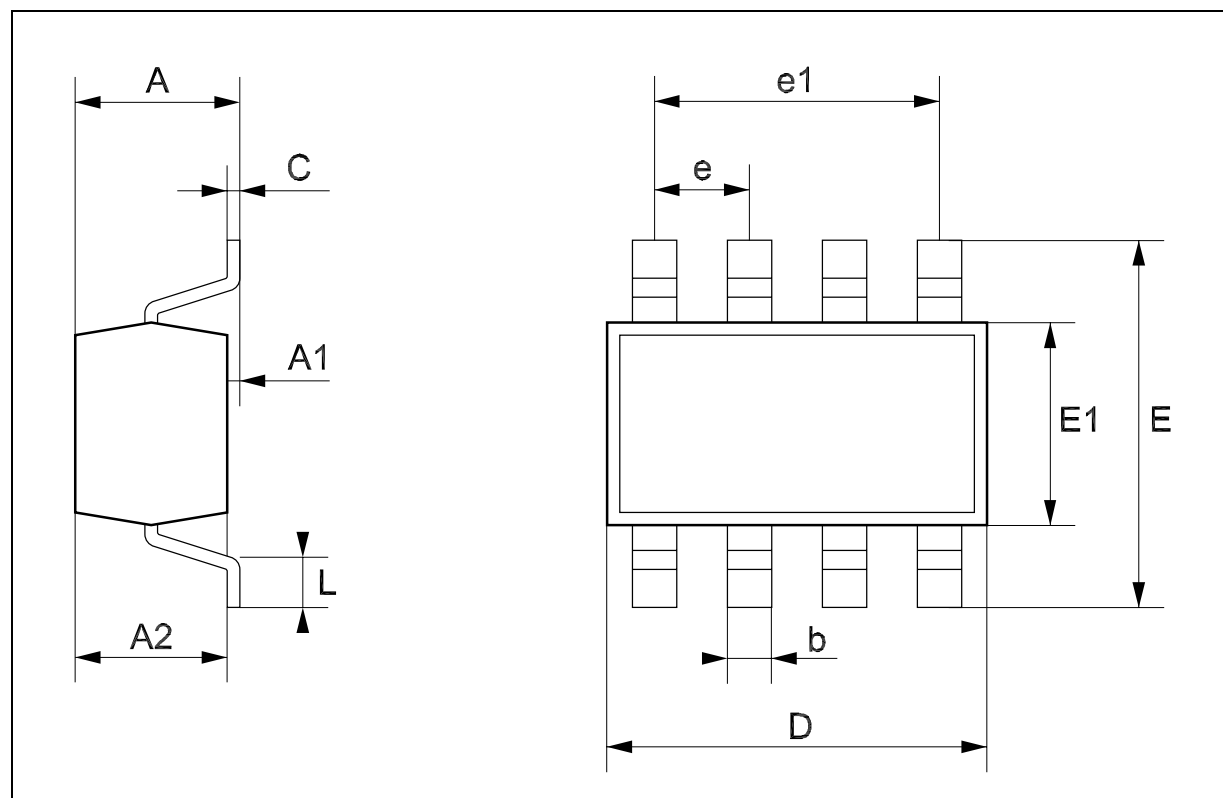

SOT323-8L MECHANICAL DATA

DIM.	mm.			mils		
	MIN.	TYP	MAX.	MIN.	TYP.	MAX.
A	0.80		1.10	31.5		43.3
A1	0.00		0.10	0.0		3.9
A2	0.80		1.00	31.5		34.9
b	0.13		0.28	5.1		11.0
C	0.10		0.18	3.9		7.1
D	1.80		2.20	70.9		86.6
E	1.80		2.40	70.9		94.5
E1	1.15		1.35	45.3		53.1
e		0.5			19.7	
e1		1.5			59.0	
L	0.10		0.30	3.9		11.8

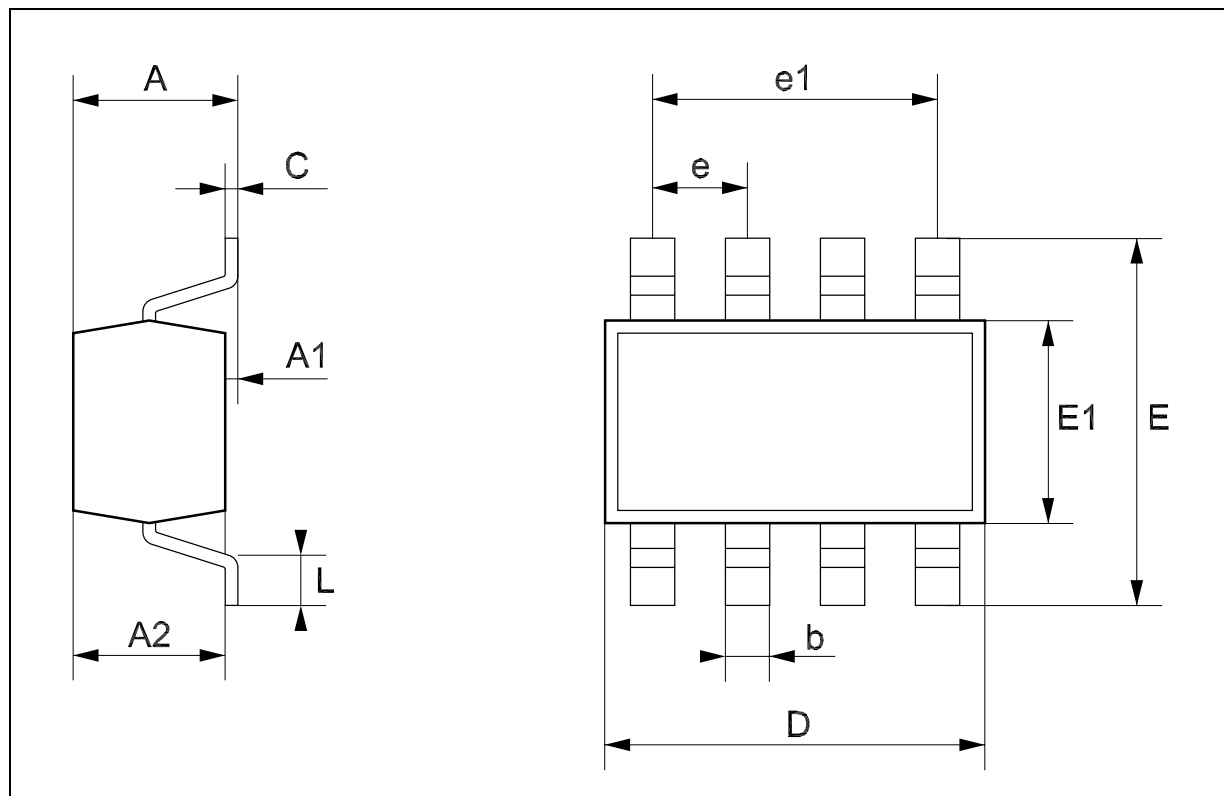

Tape & Reel SOT23-xL MECHANICAL DATA

DIM.	mm.			inch		
	MIN.	TYP	MAX.	MIN.	TYP.	MAX.
A			180			7.086
C	12.8	13.0	13.2	0.504	0.512	0.519
D	20.2			0.795		
N	60			2.362		
T			14.4			0.567
Ao	3.13	3.23	3.33	0.123	0.127	0.131
Bo	3.07	3.17	3.27	0.120	0.124	0.128
Ko	1.27	1.37	1.47	0.050	0.054	0.058
Po	3.9	4.0	4.1	0.153	0.157	0.161
P	3.9	4.0	4.1	0.153	0.157	0.161

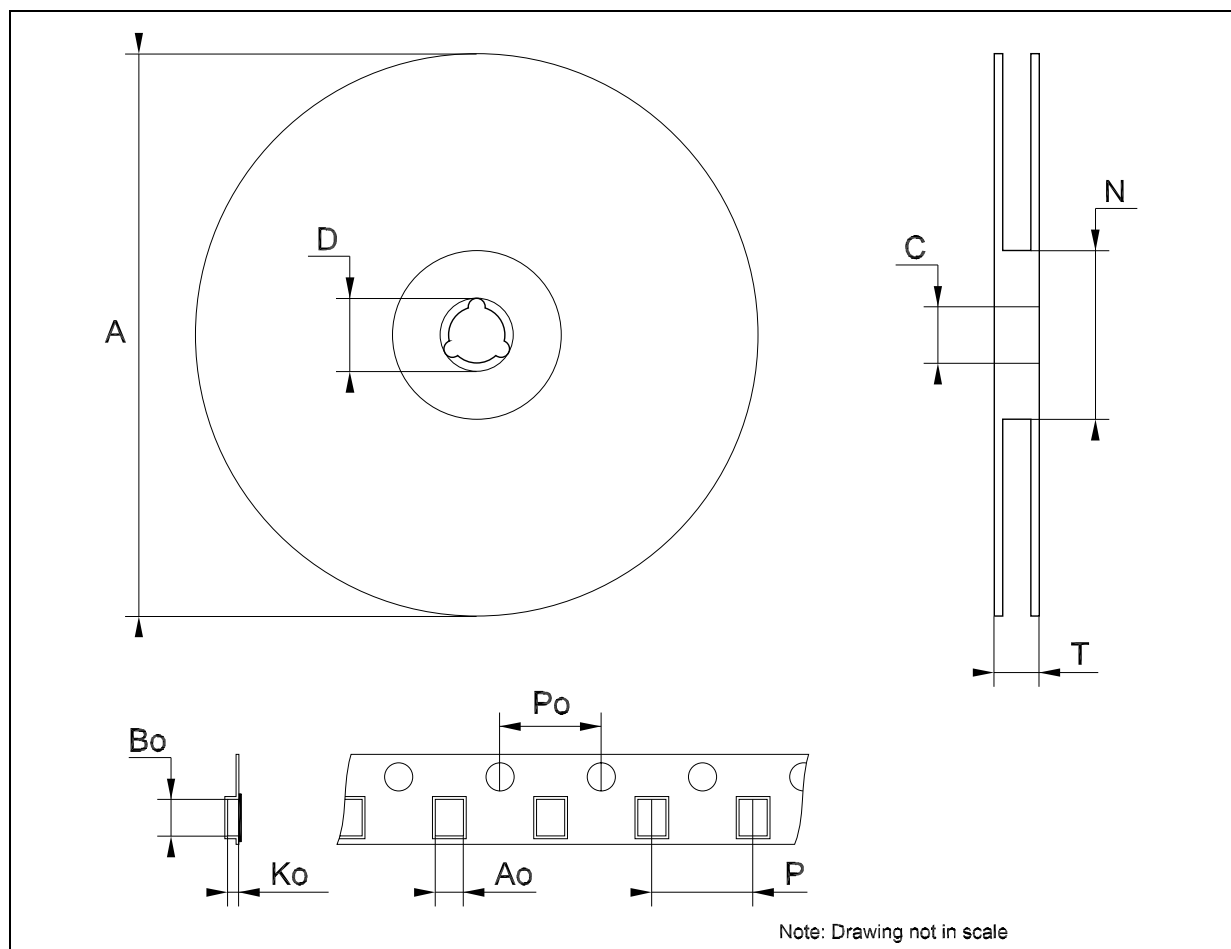

Tape & Reel SOT323-xL MECHANICAL DATA

DIM.	mm.			inch		
	MIN.	TYP	MAX.	MIN.	TYP.	MAX.
A	175	180	185	6.889	7.086	7.283
C	12.8	13	13.2	0.504	0.512	0.519
D	20.2			0.795		
N	59.5	60	60.5		2.362	
T			14.4			0.567
Ao		2.25			0.088	
Bo		2.7			0.106	
Ko		1.2			0.047	
Po	3.98	4	4.2	0.156	0.157	0.165
P	3.98	4	4.2	0.156	0.157	0.165

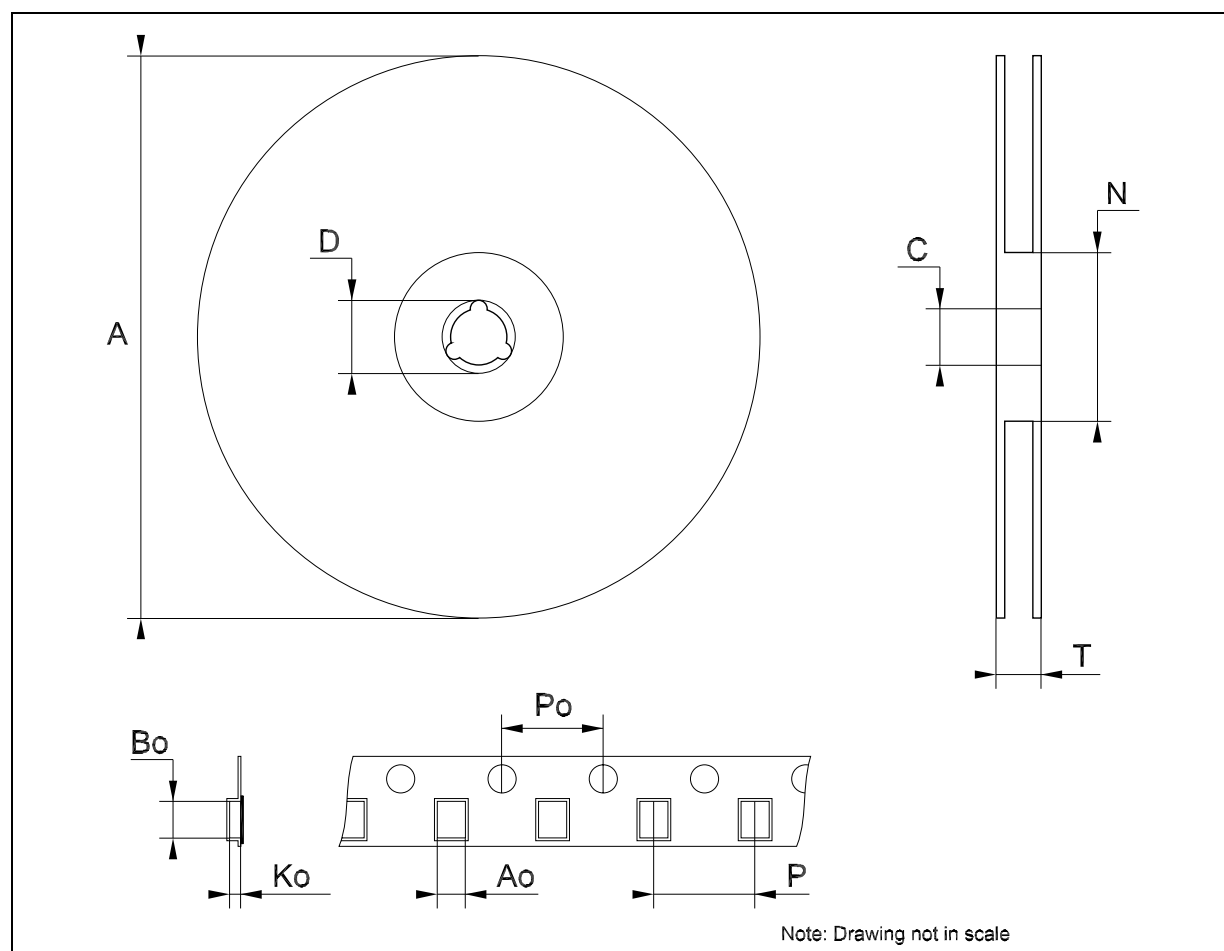

Information furnished is believed to be accurate and reliable. However, STMicroelectronics assumes no responsibility for the consequences of use of such information nor for any infringement of patents or other rights of third parties which may result from its use. No license is granted by implication or otherwise under any patent or patent rights of STMicroelectronics. Specifications mentioned in this publication are subject to change without notice. This publication supersedes and replaces all information previously supplied. STMicroelectronics products are not authorized for use as critical components in life support devices or systems without express written approval of STMicroelectronics.

© The ST logo is a registered trademark of STMicroelectronics

© 2002 STMicroelectronics - Printed in Italy - All Rights Reserved
STMicroelectronics GROUP OF COMPANIES

Australia - Brazil - Canada - China - Finland - France - Germany - Hong Kong - India - Israel - Italy - Japan - Malaysia - Malta - Morocco
Singapore - Spain - Sweden - Switzerland - United Kingdom - United States.

© <http://www.st.com>

