

***Silicon N-Channel MOSFET***

**Features**

- 7.5A,600V, $R_{DS(on)}$ (Max1.2 $\Omega$ )@ $V_{GS}=10V$
- Ultra-low Gate charge(Typical 28nC)
- Fast Switching Capability
- 100%Avalanche Tested
- Isolation Voltage ( $V_{ISO}=4000V$  AC)
- Maximum Junction Temperature Range(150 $^{\circ}C$ )

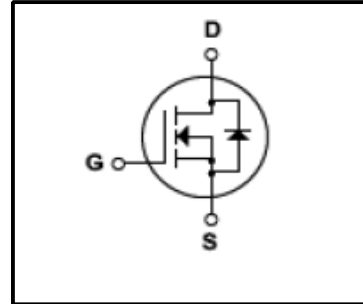

**General Description**

This Power MOSFET is produced using Winsemi's advanced planar stripe, VDMOS technology. This latest technology has been especially designed to minimize on-state resistance, have a high rugged avalanche characteristics. This device is specially well suited for half bridge and full bridge resonant topology line a electronic lamp ballast, high efficiency switched mode power supplies, active power factor correction.

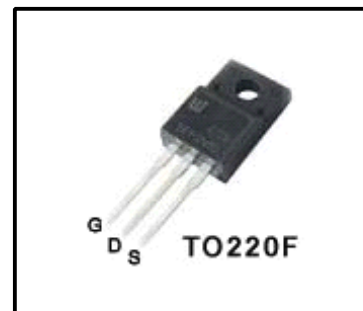

**Absolute Maximum Ratings**

Symbol	Parameter	Value	Units
$V_{DSS}$	Drain Source Voltage	600	V
$I_D$	Continuous Drain Current(@ $T_c=25^{\circ}C$ )	7.5*	A
	Continuous Drain Current(@ $T_c=100^{\circ}C$ )	4.3*	A
$I_{DM}$	Drain Current Pulsed (Note1)	30	A
$V_{GS}$	Gate to Source Voltage	$\pm 30$	V
$E_{AS}$	Single Pulsed Avalanche Energy (Note2)	240	mJ
$E_{AR}$	Repetitive Avalanche Energy (Note1)	15	mJ
$dv/dt$	Peak Diode Recovery $dv/dt$ (Note3)	4.5	V/ns
$P_D$	Total Power Dissipation(@ $T_c=25^{\circ}C$ )	48	W
	Derating Factor above 25 $^{\circ}C$	0.38	W/ $^{\circ}C$
$T_J, T_{stg}$	Junction and Storage Temperature	-55~150	$^{\circ}C$
$T_L$	Channel Temperature	300	$^{\circ}C$

\*Drain current limited by junction temperature

**Thermal Characteristics**

Symbol	Parameter	Value			Units
		Min	Typ	Max	
$R_{QJC}$	Thermal Resistance , Junction -to -Case	-	-	2.6	$^{\circ}C/W$
$R_{QJA}$	Thermal Resistance , Junction-to -Ambient	-	-	62.5	$^{\circ}C/W$

**Electrical Characteristics(Tc=25°C)**

Characteristics	Symbol	Test Condition	Min	Type	Max	Unit	
Gate leakage current	I <sub>GSS</sub>	V <sub>GS</sub> =±30V,V <sub>DS</sub> =0V	-	-	±100	nA	
Gate-source breakdown voltage	V <sub>(BR)GSS</sub>	I <sub>G</sub> =±10 μA,V <sub>DS</sub> =0V	±30	-	-	V	
Drain cut -off current	I <sub>DSS</sub>	V <sub>DS</sub> =600V,V <sub>GS</sub> =0V	-	-	10	μA	
		V <sub>DS</sub> =480V,Tc=125°C	-	-	100	μA	
Drain -source breakdown voltage	V <sub>(BR)DSS</sub>	I <sub>D</sub> =250 μA,V <sub>GS</sub> =0V	600	-	-	V	
Gate threshold voltage	V <sub>GS(th)</sub>	V <sub>DS</sub> =10V,I <sub>D</sub> =250 μA	2	-	4	V	
Drain -source ON resistance	R <sub>DS(ON)</sub>	V <sub>GS</sub> =10V,I <sub>D</sub> =3.75A	-	0.8	1.2	Ω	
Forward Transconductance	g <sub>fs</sub>	V <sub>DS</sub> =50V,I <sub>D</sub> =3.75A	-	8.7	-	S	
Input capacitance	C <sub>iss</sub>	V <sub>DS</sub> =25V,	-	1100	1430	pF	
Reverse transfer capacitance	C <sub>rss</sub>	V <sub>GS</sub> =0V,	-	16	21		
Output capacitance	C <sub>oss</sub>	f=1MHz	-	135	175		
Switching time	Rise time	tr	V <sub>DD</sub> =200V, I <sub>D</sub> =7.5A R <sub>G</sub> =25Ω (Note4,5)	-	30	70	ns
	Turn-on time	ton		-	80	170	
	Fall time	tf		-	65	140	
	Turn-off time	toff		-	60	130	
Total gate charge(gate-source plus gate-drain)	Q <sub>g</sub>	V <sub>DD</sub> =480V, V <sub>GS</sub> =10V,	-	28	36	nC	
Gate-source charge	Q <sub>gs</sub>	I <sub>D</sub> =7.5A	-	7	-		
Gate-drain("miller") Charge	Q <sub>gd</sub>	(Note4,5)	-	14.5	-		

**Source-Drain Ratings and Characteristics(Ta=25°C)**

Characteristics	Symbol	Test Condition	Min	Type	Max	Unit
Continuous drain reverse current	I <sub>DR</sub>	-	-	-	7.5	A
Pulse drain reverse current	I <sub>DRP</sub>	-	-	-	28	A
Forward voltage(diode)	V <sub>DSF</sub>	I <sub>DR</sub> =7.5A,V <sub>GS</sub> =0V	-	-	1.4	V
Reverse recovery time	trr	I <sub>DR</sub> =7.5A,V <sub>GS</sub> =0V,	-	320	-	ns
Reverse recovery charge	Q <sub>rr</sub>	dI <sub>DR</sub> / dt =100 A / μs	-	2.4	-	μC

Note 1.Repeativity rating :pulse width limited by junction temperature

2.L=18.5mH I<sub>AS</sub>=7.5A,V<sub>DD</sub>=50V,R<sub>G</sub>=0Ω,Starting T<sub>J</sub>=25°C

3.I<sub>SD</sub>≤7.5A,di/dt≤200A/us,V<sub>DD</sub><BV<sub>DSS</sub>,STARTING T<sub>J</sub>=25°C

4.Pulse Test:Pulse Width≤300us,Duty Cycle≤2%

5. Essentially independent of operating temperature.

This transistor is an electrostatic sensitive device

Please handle with caution

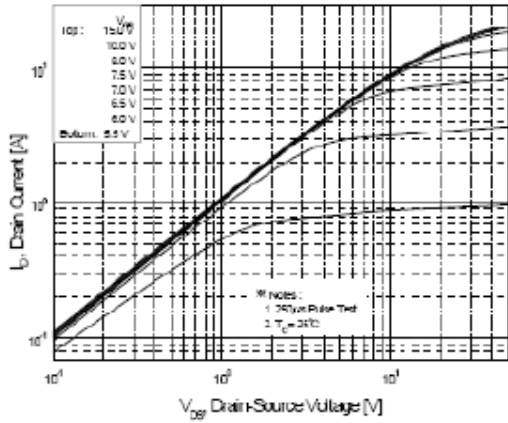

**Fig.1 On State Characteristics**

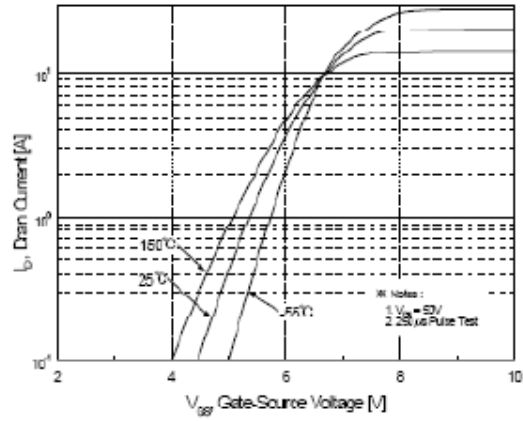

**Fig.2 Transfer Current Characteristics**

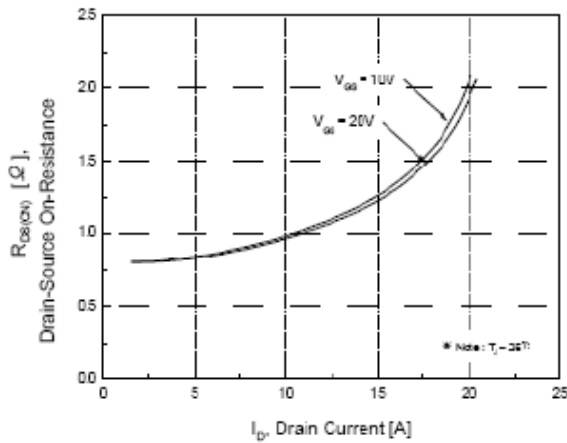

**Fig.3 On-Resistance Variation vs Drain Current**

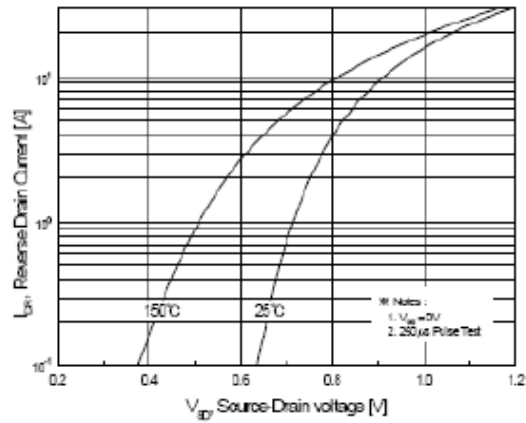

**Fig.4 Body Diode Forward Voltage Variation with Source Current and Temperature**

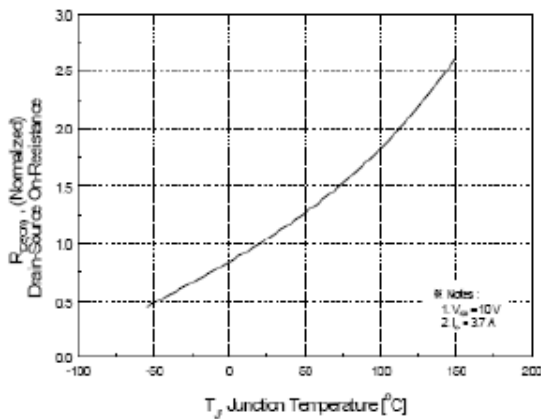

**Fig.5 On-Resistance Variation vs Junction Temperature**

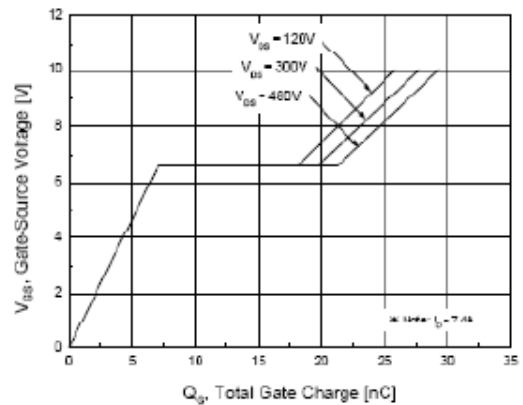

**Fig.6 Gate Charge Characteristics**

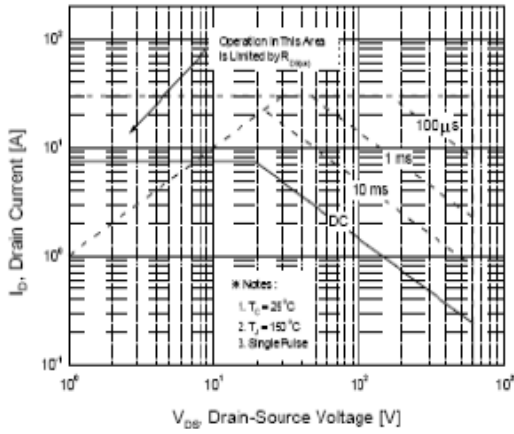

**Fig.7 Maximum Safe Operation Area**

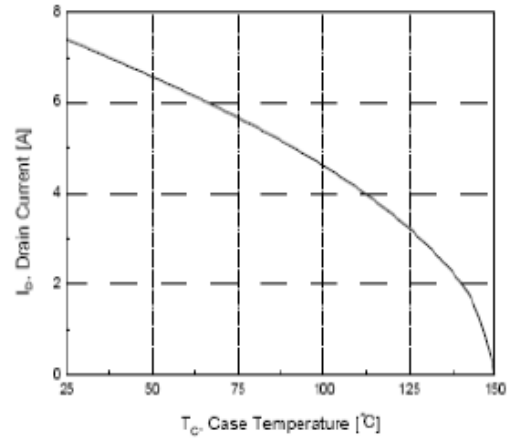

**Fig.8 Maximum Drain Current vs Case Temperature**

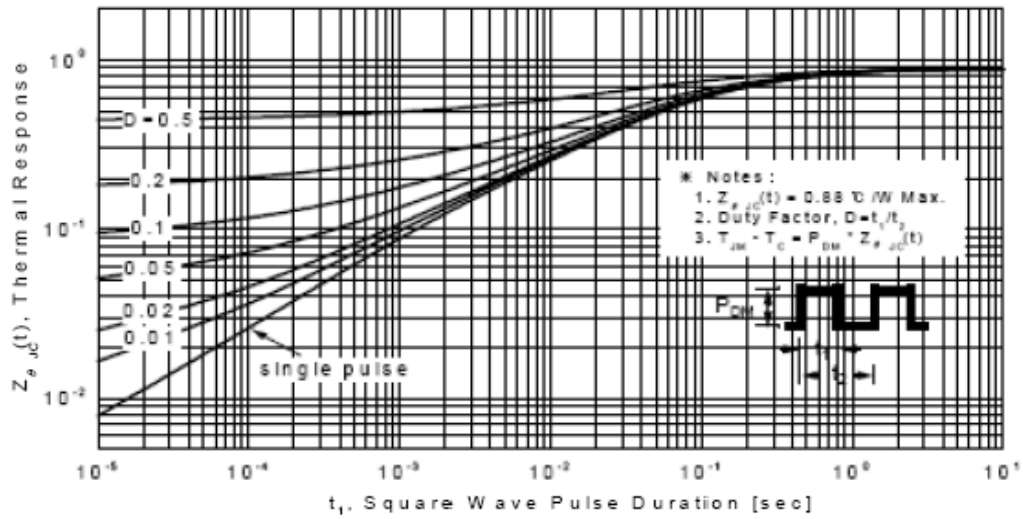

**Fig.9 Transient Thermal Response Curve**

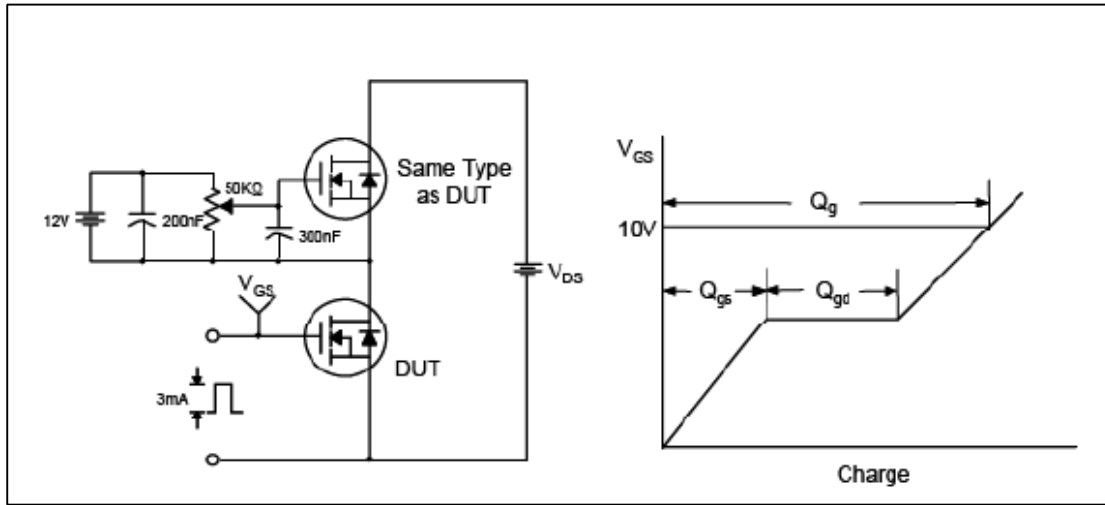

**Fig.10 Gate Test Circuit & Waveform**

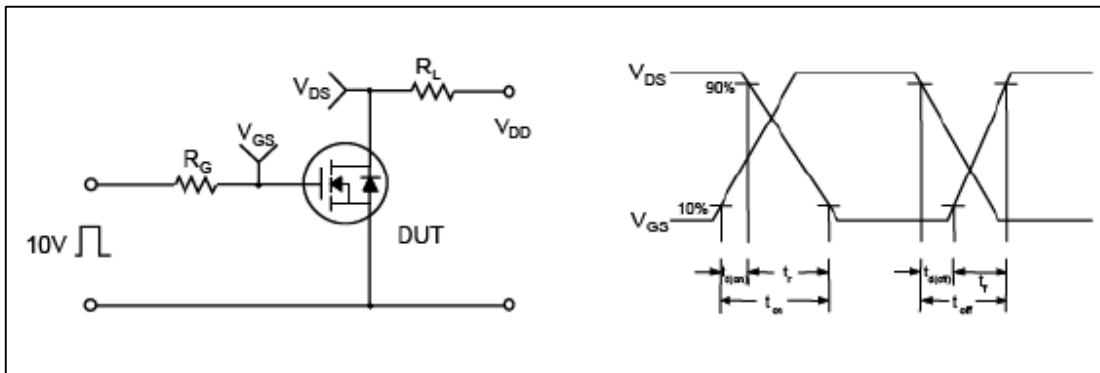

**Fig.11 Resistive Switching Test Circuit & Waveform**

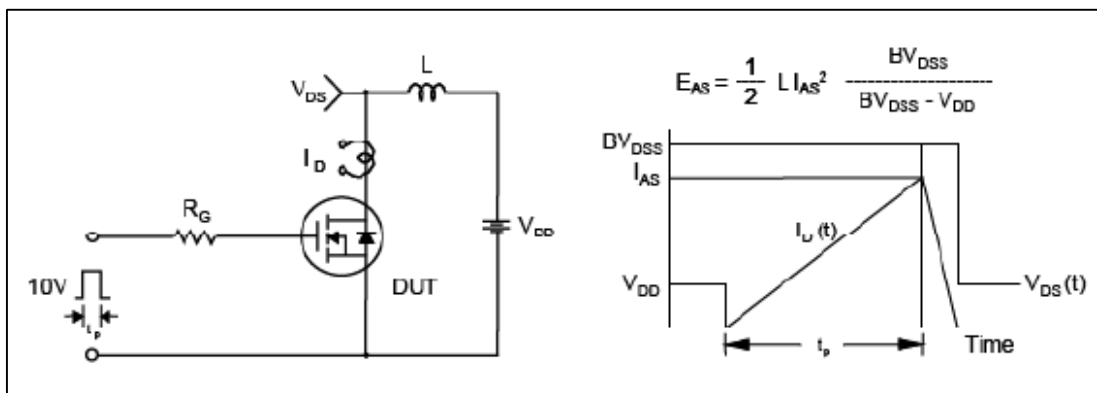

**Fig.12 Unclamped Inductive Switching Test Circuit & Waveform**

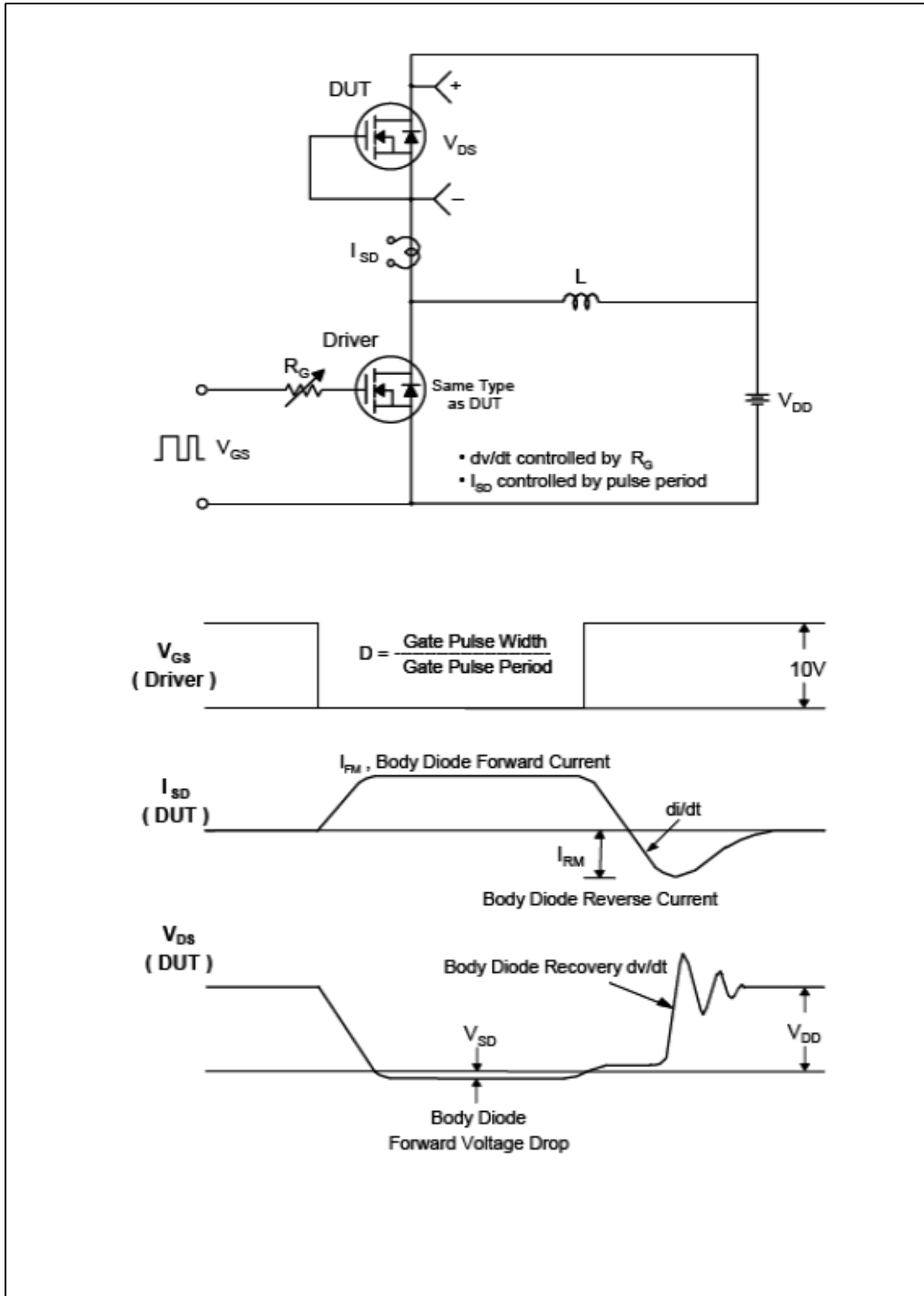

**Fig.13 Peak Diode Recovery dv/dt Test Circuit & Waveform**

**TO-220F Package Dimension**

