

Package: P22, 15.24mm x 15.24mm x 5.58mm



Features

- Internal Microcontroller
- Programmable START/STOP/Step Size
- SPI BUS Compatible
- Frequency: 1700MHz to 2000MHz
- Resonator: Microstrip
- PCB: Rogers
- Package Size: 15.24mm x 15.24mm x 5.58mm (0.6in x 0.6in x 0.22in)

Applications

- Highly Integrated Radio Designs
- High-Performance Radios
- Microwave Radio IF Conversion
- Instrumentation
- Frequency Synthesizers

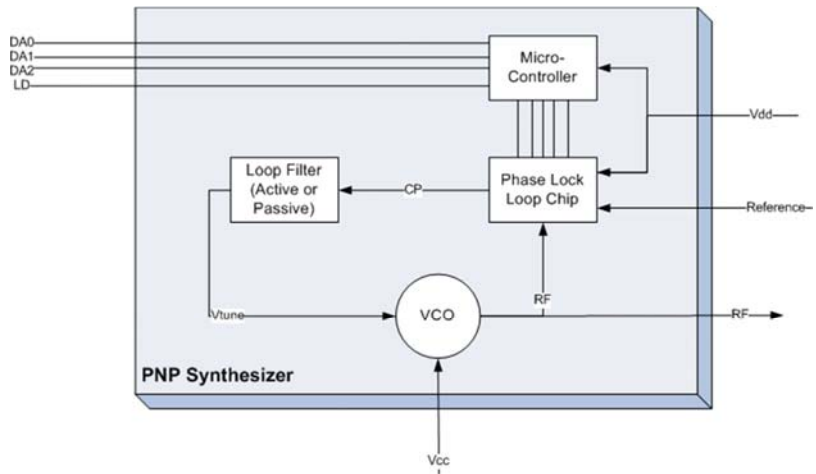

Functional Block Diagram

Product Description

RFMD offers complete Plug-N-Play Synthesizers (PNPs) for low noise frequency synthesizer applications consisting of a VCO, PLL, loop filter and Micro-controller interface. The PNP family of RF signal sources is the world's first family of truly configurable frequency synthesizer modules. These synthesizers can make quick adjustments with amazing accuracy, speed, and performance.

Ordering Information

PNP-383-P22-G Contact us at 1-480-756-6070

Optimum Technology Matching® Applied

- | | | | |
|--------------------------------------|--------------------------------------|--|------------------------------------|
| <input type="checkbox"/> GaAs HBT | <input type="checkbox"/> SiGe BiCMOS | <input type="checkbox"/> GaAs pHEMT | <input type="checkbox"/> GaN HEMT |
| <input type="checkbox"/> GaAs MESFET | <input type="checkbox"/> Si BiCMOS | <input type="checkbox"/> Si CMOS | <input type="checkbox"/> BiFET HBT |
| <input type="checkbox"/> InGaP HBT | <input type="checkbox"/> SiGe HBT | <input checked="" type="checkbox"/> Si BJT | <input type="checkbox"/> LDMOS |

RF MICRO DEVICES®, RFMD®, Optimum Technology Matching®, Enabling Wireless Connectivity™, PowerStar®, POLARIS™ TOTAL RADIO™ and UltimateBlue™ are trademarks of RFMD, LLC. BLUETOOTH is a trademark owned by Bluetooth SIG, Inc., U.S.A. and licensed for use by RFMD. All other trade names, trademarks and registered trademarks are the property of their respective owners. ©2012, RF Micro Devices, Inc.

Absolute Maximum Ratings

Parameter	Rating	Unit
Operating Ambient Temperature	-40 to +85	°C
Storage Temperature	-55 to +125	°C



Caution! ESD sensitive device.

Exceeding any one or a combination of the Absolute Maximum Rating conditions may cause permanent damage to the device. Extended application of Absolute Maximum Rating conditions to the device may reduce device reliability. Specified typical performance or functional operation of the device under Absolute Maximum Rating conditions is not implied.

The information in this publication is believed to be accurate and reliable. However, no responsibility is assumed by RF Micro Devices, Inc. ("RFMD") for its use, nor for any infringement of patents, or other rights of third parties, resulting from its use. No license is granted by implication or otherwise under any patent or patent rights of RFMD. RFMD reserves the right to change component circuitry, recommended application circuitry and specifications at any time without prior notice.



RoHS (Restriction of Hazardous Substances): Compliant per EU Directive 2002/95/EC.

Parameter	Specification			Unit	Condition
	Min.	Typ.	Max.		
Overall					
Frequency Range	1700		2000	MHz	
Step Size	500		10000	kHz	
Output Power	7	9	11	dBm	
Output Phase Noise		-97	-93	dBc/Hz	1 kHz
		-102	-97	dBc/Hz	10 kHz
		-115	-110	dBc/Hz	100 kHz
		-145	-140	dBc/Hz	1000 kHz
Spurious Product		-70	-60	dBc	500kHz step size
Reference Feedthrough		-80	-71	dBc	
Second Harmonic		-20	-10	dBc	
Reference Oscillator Signal		10		MHz	Frequency
	0		3.3	V _{P-P}	Amplitude - DC coupled
Power Supply					
Operating Voltage	9.7	10	10.3	V	V1
	2.7	3	3.3	V	V2
Supply Current		50	60	mA	I1
		25	35	mA	I2

Notes:

- 1) Reference Input Level: -5dBm minimum, +5dBm maximum, AC coupled.
- 2) Specification Test Conditions: V1 = 10V, V2 = 3V, REF = 10MHz.

Package Drawing & Pin Outs

15.24mm x 15.24mm x 5.58mm (0.6in x 0.6in x 0.22in)

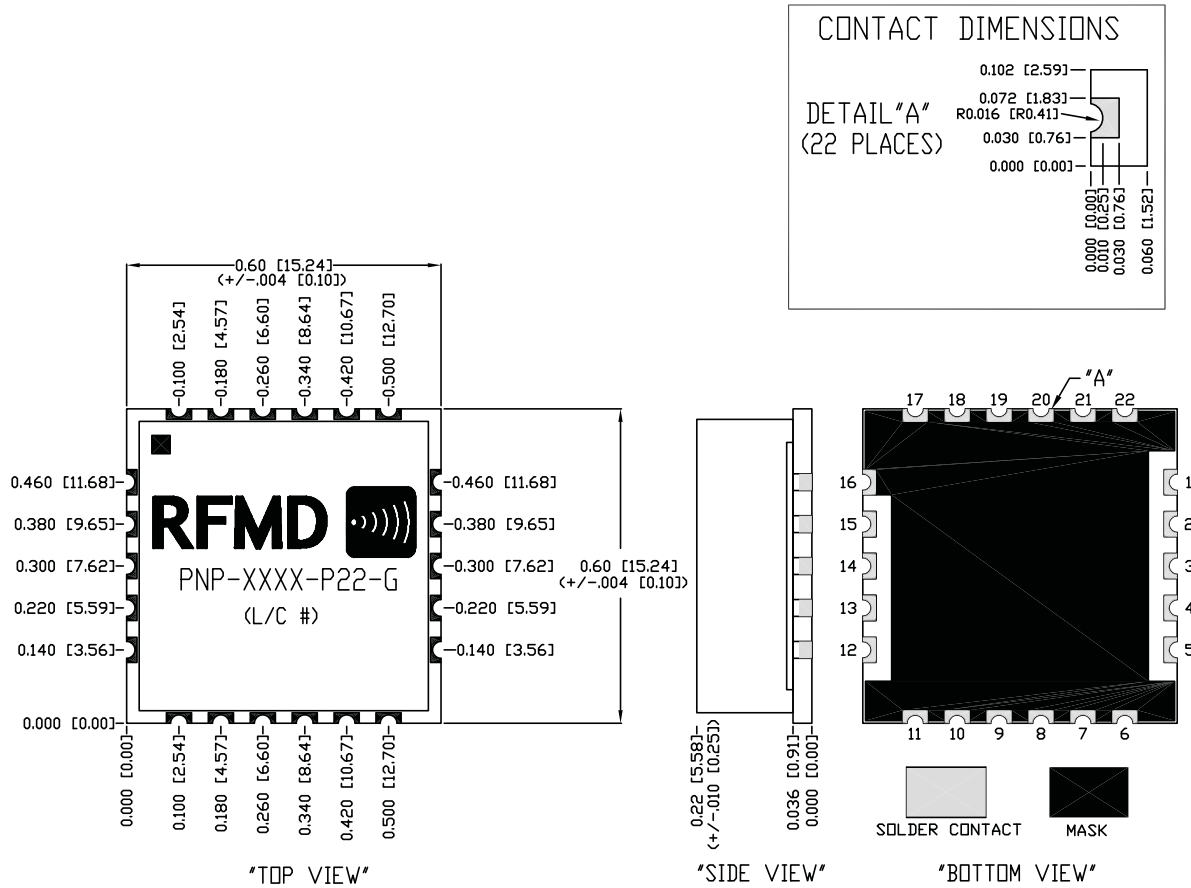

CONTACT ASSIGNMENTS:	
1: DA0	12: RF OUTPUT
2: DA1	13: V1, ANALOG SUPPLY INPUT
3: DA2	14: V2, DIGITAL SUPPLY INPUT
4: LOCK DETECT	15: REFERENCE INPUT
5: NO CONNECT	ALL OTHER CONTACTS ARE GROUND