

DATE	REV.	DESCRIPTION	DR	CK	REL

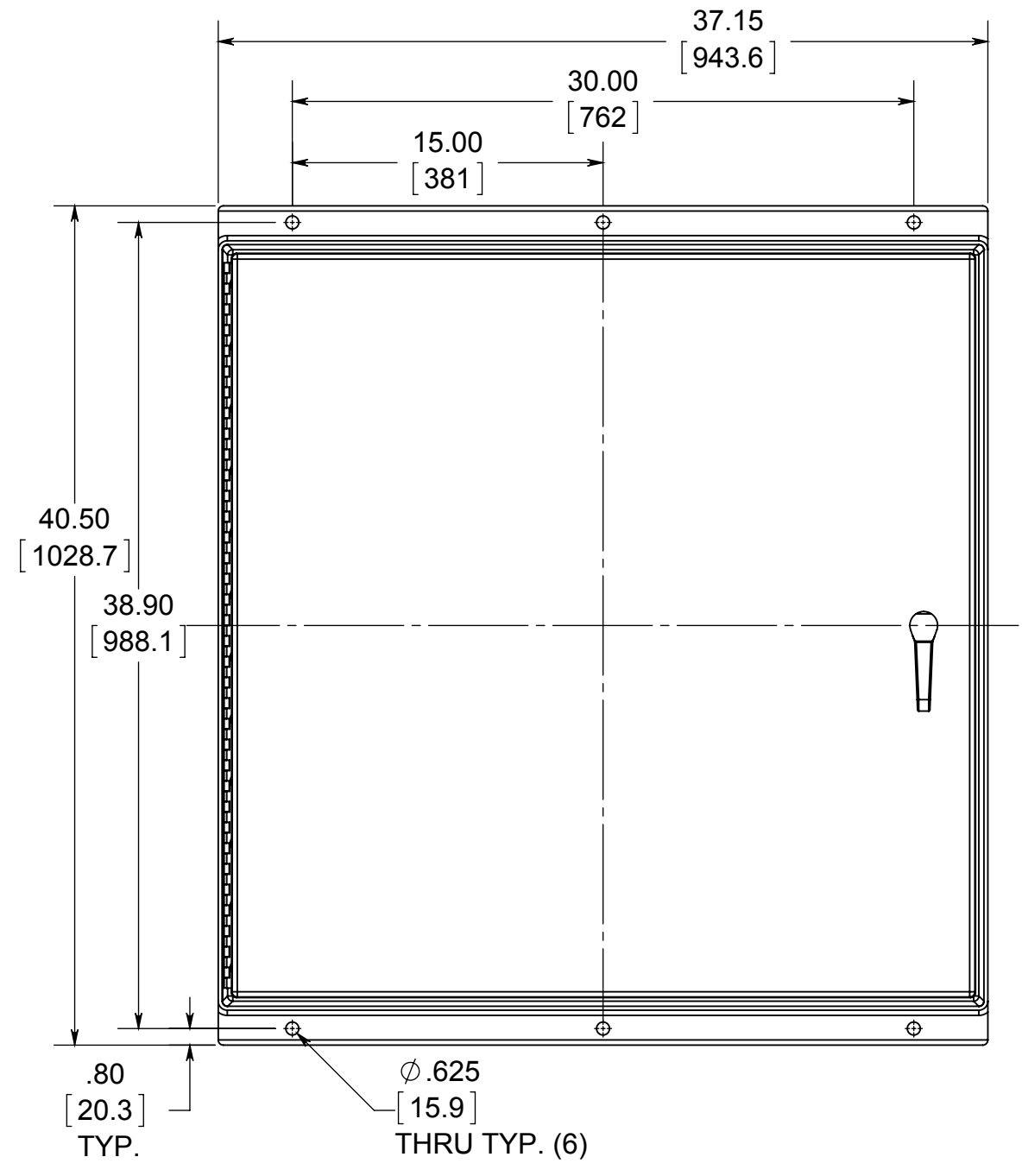

FRONT VIEW WITH COVER

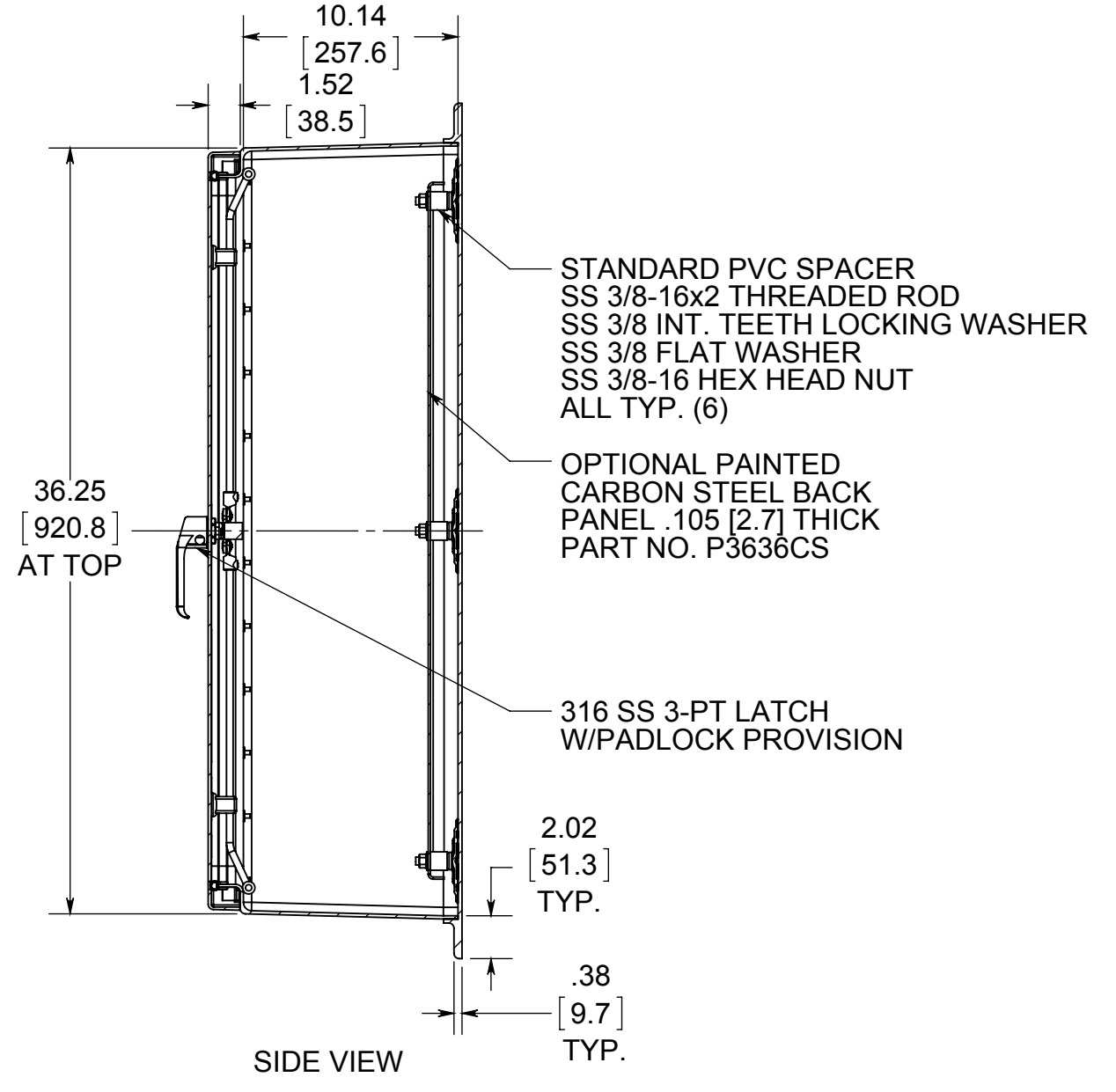

SIDE VIEW

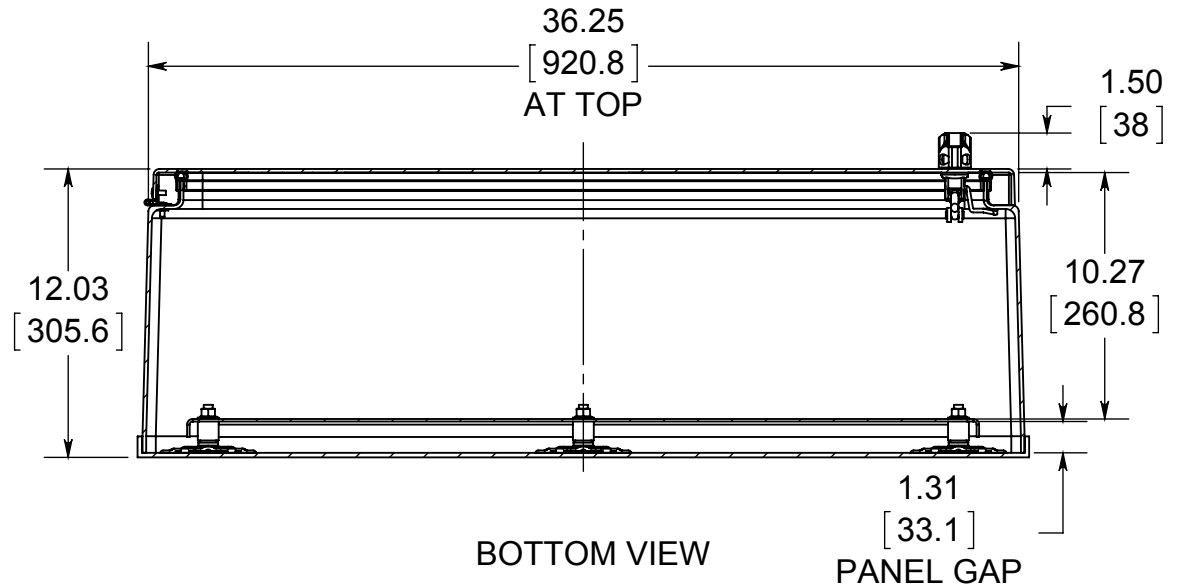

BOTTOM VIEW

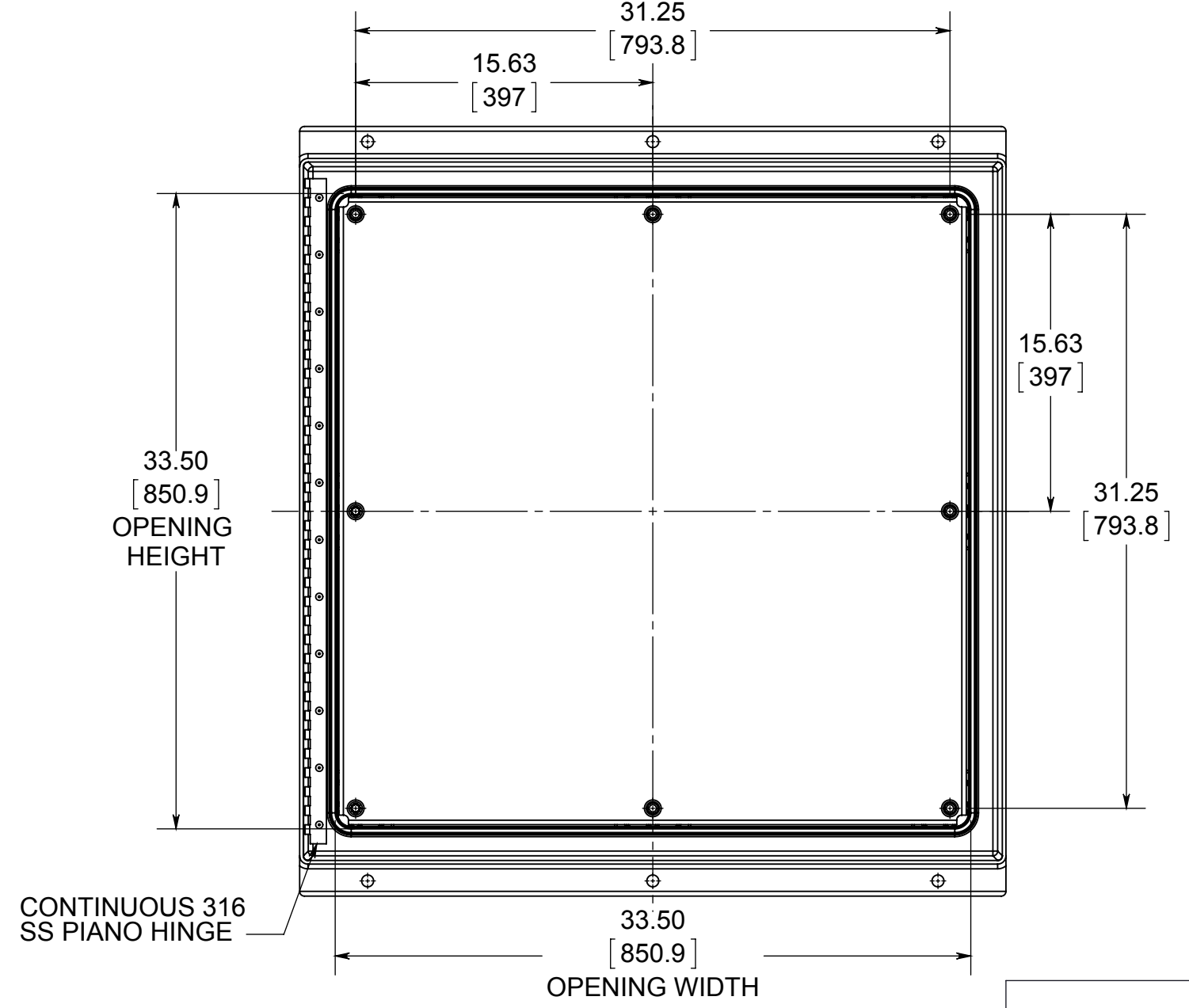

FRONT VIEW WITH COVER REMOVED

NOM. .19 [4.8] WALL THICKNESS

MATERIAL:
 BOX- GEL-COAT, FIBERGLASS, RESIN
 COVER- GEL-COAT, FIBERGLASS, RESIN
 EPDM GASKET SEAL

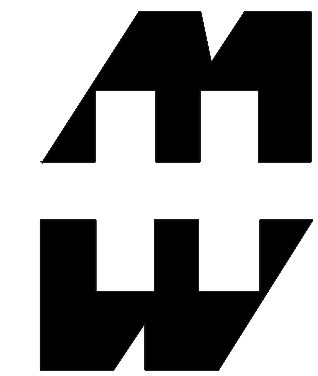

PART No. PJW363610L3PT
 for more information visit
www.hammfg.com
 Data subject to change without notice
 Drawing Not to Scale