

Description:

M81500FP is a high voltage three-phase motor driver fabricated by a 500V high voltage SOI (Silicon On Insulator) process. This driver contains level shift high-side driver, low-side driver, IGBT's, free-wheel diodes, protective functions for over-current, under-voltage protection circuits and thermal shutdown circuit.

Features:

- 500V Floating Supply Voltage
- Built in Bootstrap Diodes
- 3-Phase Bridge Output using IGBTs
- Built in Free-Wheel Diodes

Applications:

- Exhaust Fans
- Dishwashers
- Air Conditioners
- Small Servo Motors
- Small Motor Control

Ordering Information:
M81500FP

Outline Drawing and Circuit Diagram

Dimensions	Inches	Millimeters
A	0.47±0.012	11.93±0.3
B	0.69±0.008	17.5±0.2
C	0.33±0.012	8.4±0.3
D	0.063	1.6
E	0.03	0.75
F	0.035 Max.	0.9 Max.
G	0.08	2.0
H	0.086 Max.	2.2 Max.
J	0.07	1.765
K	0.004±0.004	0.1±0.1

Dimensions	Inches	Millimeters
L	0 ~ 10°	
M	0.02±0.008	0.5±0.2
N	0.01+0.002/-0.0008	0.25+0.05/-0.02
P	0.45	11.43
Q	0.063	1.6
R	0.05	1.3
S	0.05	1.27
T	0.0315	0.8
U	0.02	0.5
V	0.012±0.002	0.3±0.05



Powerex, Inc., 173 Pavilion Lane, Youngwood, Pennsylvania 15697 (724) 925-7272 www.pwr.com

M81500FP
Intellimod™ HVIC
Single Chip Inverter

Absolute Maximum Ratings, $T_a = 25^\circ\text{C}$ unless otherwise specified

Characteristics	Symbol	M81500FP	Units
Collector-Emitter Voltage	V_{CES}	-0.5 ~ 500	Volts
Control Power Supply Voltage	V_D	-0.5 ~ 23	Volts
Input Voltage ($U_{PIN}, V_{PIN}, W_{PIN}, UN_{IN}, VN_{IN}, WN_{IN}$)	V_{IN}	-0.5 ~ $V_{CC}+0.5$	Volts
Collector Current	I_C	0.6	Amperes
Peak Collector Current	I_{CP}	1.0	Amperes
Power Dissipation (On Board, $T_a = 25^\circ\text{C}$)	P_D	2.6	Watts
Power Dissipation (On Board, $T_C = 25^\circ\text{C}$)	P_D	25	Watts
Junction Temperature	T_j	-20 ~ 150	$^\circ\text{C}$
Operating Temperature	T_{opr}	-20 ~ 125	$^\circ\text{C}$
Storage Temperature	T_{stg}	-55 ~ 150	$^\circ\text{C}$

Recommended Conditions for Use

Characteristic	Symbol	Condition	Min.	Typ.	Max.	Units
High Voltage Supply	V_{CC}	Applied across P-N Terminals	50	280	450	Volts
Control Power Supply Voltage	V_D		15.675	16.5	17.325	Volts
Input Voltage ($U_{PIN}, V_{PIN}, W_{PIN}, UN_{IN}, VN_{IN}, WN_{IN}$)	V_{IN}		0	—	7	Volts

M81500FP
Intellimod™ HVIC
Single Chip Inverter

Electrical and Mechanical Characteristics, $T_j = 25^\circ\text{C}$ unless otherwise specified

Characteristics	Symbol	Test Conditions	Min.	Typ.	Max.	Units
Floating Bootstrap Standby Current (Applied between U_{FB-U} , V_{FB-V} , W_{FB-W})	I_{FB}	* $P_{IN} = *N_{IN} = 0V$ (* = U, V, W), $FB = 16.5V$ (U-Phase, V-Phase, W-Phase Common)	—	0.2	0.6	mA
Power Supply Voltage Standby Current	I_D	* $P_{IN} = *N_{IN} = 0V$	0.4	1.0	1.8	mA
High Level Input Threshold Voltage	V_{IH}	* P_{IN} , * N_{IN} Pin	3.5	—	—	Volts
Low Level Input Threshold Voltage	V_{IL}	* P_{IN} , * N_{IN} Pin	—	—	1.5	Volts
High Level Input Bias Current	I_{IH}	$V_{IN} = 5V$	—	25	50	μA
Low Level Input Bias Current	I_{IL}	$V_{IN} = 0V$	—	0	2	μA
Floating Bootstrap Supply UV Reset Voltage	FB_{Uvr}	U-Phase, V-Phase, W-Phase Common	7.9	8.7	9.7	Volts
Floating Bootstrap Supply UV Trip Voltage	FB_{Uvt}	U-Phase, V-Phase, W-Phase Common	7.4	8.2	9.0	Volts
Floating Bootstrap Supply UV Hysteresis Voltage	FB_{Uvh}	U-Phase, V-Phase, W-Phase Common	0.35	0.5	—	Volts
Floating Bootstrap Supply UV Filter Time	t_{FBuv}	U-Phase, V-Phase, W-Phase Common	—	6.0	—	μs
Power Supply UV Reset Voltage	V_{Duvr}	U-Phase, V-Phase, W-Phase Common	7.9	8.7	9.7	Volts
Power Supply UV Trip Voltage	V_{Duvt}	U-Phase, V-Phase, W-Phase Common	7.4	8.2	9.0	Volts
Power Supply UV Hysteresis Voltage	V_{Duvh}	U-Phase, V-Phase, W-Phase Common	0.35	0.5	—	Volts
Power Supply UV Filter Time	t_{VDuv}	U-Phase, V-Phase, W-Phase Common	—	6.0	—	μs
Short Current Trip Level	V_{SC}	C_{IN} Pin Input Voltage (FO : H \rightarrow L)	0.43	0.50	0.55	Volts
Fault Output Voltage	V_{FoL}	$C_{IN} = 1V$, $I_{FO} = 1mA$	—	—	0.95	Volts
Output ON Delay Time	t_{on}	$V_{CC} = 280V$, $V_D = 16.5V$, $I_C = 0.5A$, $L = 5mH$	—	0.4	—	μs
Output OFF Delay Time	t_{off}	$V_{CC} = 280V$, $V_D = 16.5V$, $I_C = 0.5A$, $L = 5mH$	—	0.9	—	μs
FWD Reverse Recovery Time	t_{rr}	$V_{CC} = 280V$, $V_D = 16.5V$, $I_C = 0.5A$, $L = 5mH$	—	220	—	ns
Input Filter Time (ON)	t_{inon}		90	150	210	ns
Input Filter Time (OFF)	t_{inoff}		100	170	240	ns
Output Saturation Voltage	$V_{CE(sat)}$	$V_D = 16.5V$, $I_F = 0.5A$ (U-Phase, V-Phase, W-Phase Common)	—	2.3	3.0	Volts
Diode Forward Voltage	V_{Fwd}	$I_F = 0.5A$ (U-Phase, V-Phase, W-Phase Common)	—	1.95	2.5	Volts
Bootstrap Diodes Forward Voltage	V_{Fbsd}	$I_F = 600\mu A$ (U-Phase, V-Phase, W-Phase Common)	—	0.75	1.0	Volts
Over-Temperature Trip Level	OT_t	Chip Temperature (FO: H \rightarrow L)	—	140	—	$^\circ C$
Over-Temperature Reset Level	OT_r	Chip Temperature (FO: H \rightarrow L)	—	120	—	$^\circ C$
Over-Temperature Hysteresis Level	OT_h	$OT_t - OT_r$	—	20	—	$^\circ C$

M81500FP
 Intellimod™ HVIC
 Single Chip Inverter

Timing Requirement

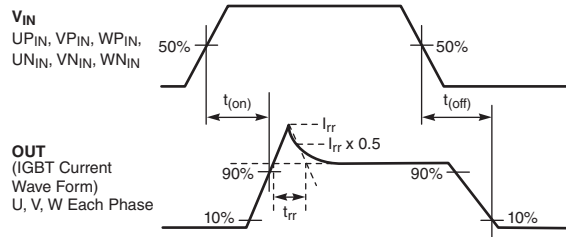

Timing Diagram

1. Input / Output Timing Diagram

ACTIVE HIGH (When input signal, H_{IN} or L_{IN} is "H", then IGBT Upper or Lower arm is "ON".)
 In the case of both input signals, H_{IN} and L_{IN} of same phase are "H", IGBT Upper and Lower is "OFF".

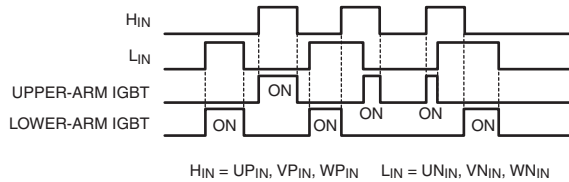

2. V_D Floating Bootstrap (FB) Supply Under-Voltage Lockout Timing Diagram

When V_D supply voltage keeps lower UV trip voltage (V_{Duvt} = V_{Duvr} - V_{Duvh}) for V_D supply UV filter time, output signal becomes "OFF". And then V_D supply voltage is higher than UV reset voltage, input signal (L_{IN}) is H; the Lower-arm IGBT becomes "ON". At this time, the Upper-arm IGBT continues operating according to the input.

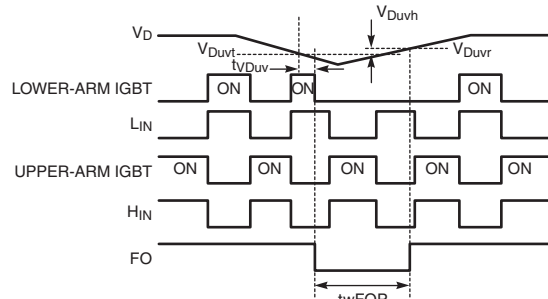

When Floating Bootstrap supply voltage keeps lower UV trip voltage (FB_{uvt} = FB_{uvr} - FB_{uvh}) for supply UV filter time, the Upper-arm IGBT becomes "OFF". And then, Floating Bootstrap supply voltage is higher than UV reset voltage, the Upper-arm IGBT keeps "OFF" until next input signal H_{IN} is "H".

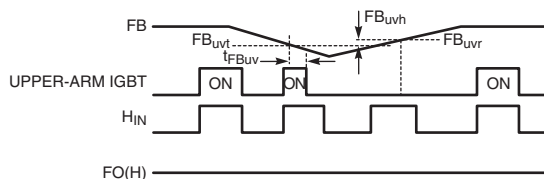

M81500FP
Intellimod™ HVIC
Single Chip Inverter

3. Short Current Lockout Timing Diagram

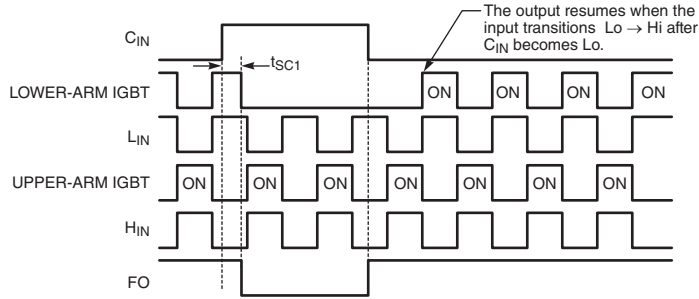

4. Over-Temperature Lockout Timing Diagram

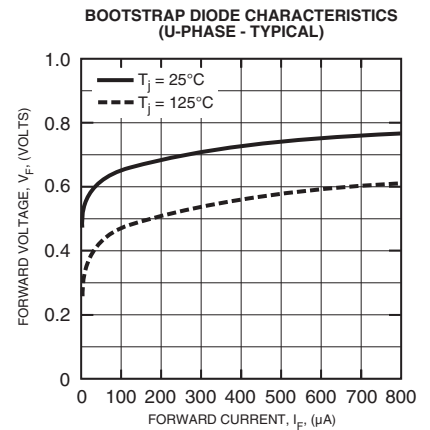
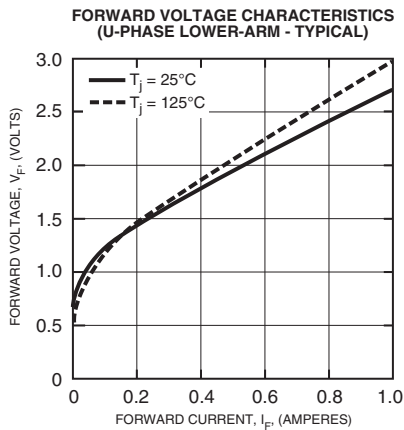
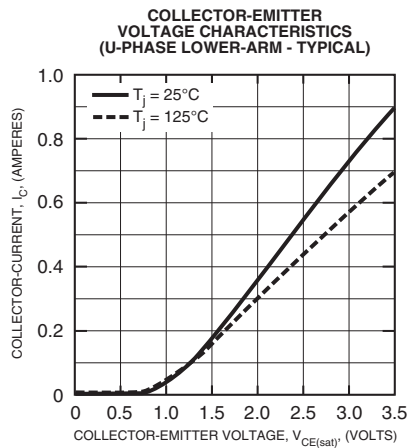
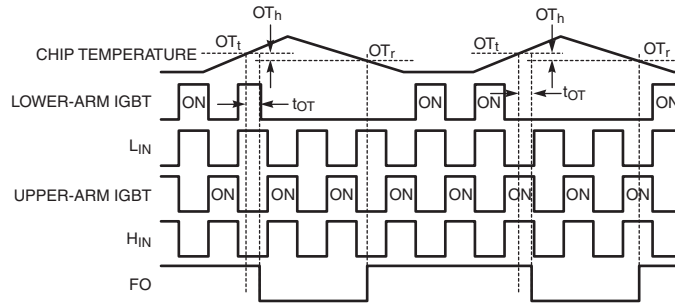



M81500FP
Intellimod™ HVIC
Single Chip Inverter

STANDBY CURRENT VS. SUPPLY VOLTAGE CHARACTERISTICS (TYPICAL)

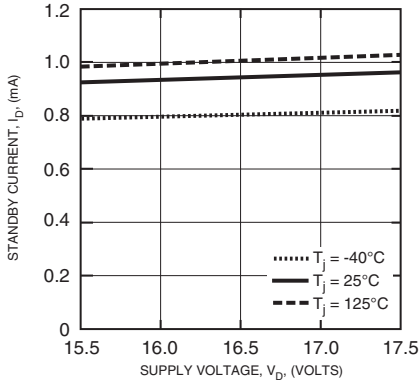

FLOATING BOOTSTRAP CHARACTERISTICS (TYPICAL)

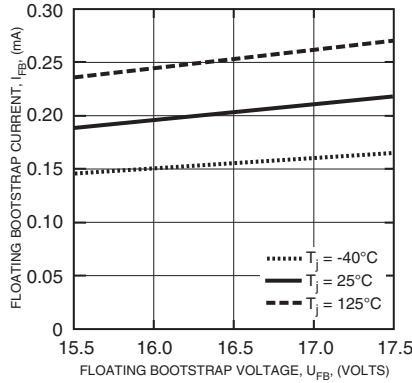

SWITCHING TIME VS. JUNCTION TEMPERATURE CHARACTERISTICS (TYPICAL)

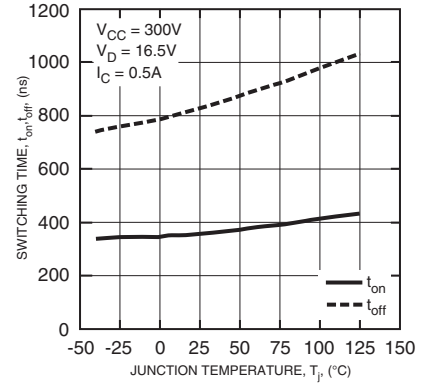

SUPPLY VOLTAGE VS. JUNCTION TEMPERATURE CHARACTERISTICS (TYPICAL)

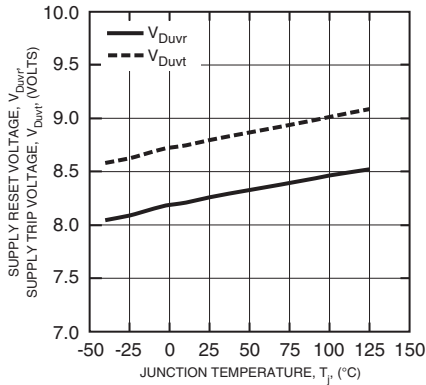

FLOATING BOOTSTRAP VOLTAGE VS. JUNCTION TEMPERATURE CHARACTERISTICS (TYPICAL)

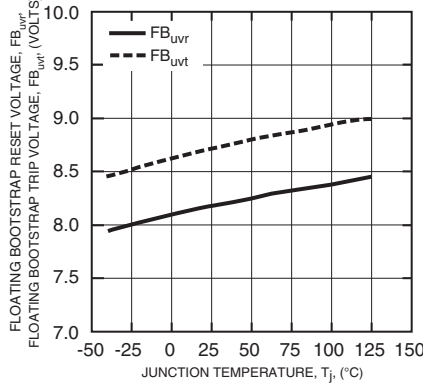

SWITCHING LOSS (ON) VS. JUNCTION TEMPERATURE CHARACTERISTICS (TYPICAL)

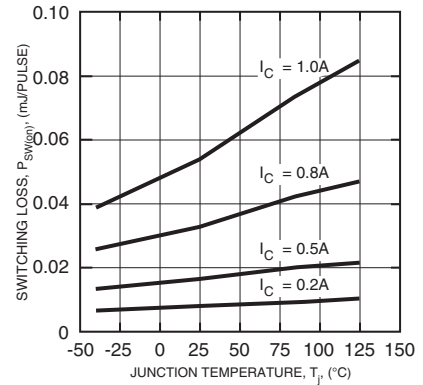

SWITCHING LOSS (OFF) VS. JUNCTION TEMPERATURE CHARACTERISTICS (TYPICAL)

