



LIGITEK ELECTRONICS CO.,LTD.
Property of Ligitek Only

1W Power Light LED

LGFLB-321E-60

DATA SHEET

DOC. NO : QW0905- LGFLB-321E-60

REV : A

DATE : 28 - Dec. -2011



Features

- *. High Flux per LED
- *. Very long operating life(up to 100k hours).
- *. Available in White.
- *. More Energy Efficient than Incandescent and most Halogen lamps.
- *. Low voltage DC operated..
- *. Cool beam, safe to the touch.
- *. Instant light(less than 100 ns).
- *. Fully dimmable.
- *. No UV.
- *. Superior ESD protection..
- *. Soldering methods: hand Soldering or reflow solder.

Typical Applications

- *. Reading Light (car,bus,aircraft)
- *. Portable(flashlight,bicycle).
- *. LCD Backlights / Light Guides.
- *. Automotive Exterior (Stop-Tail-Tum,CHMSL,Mirror Side Repeat).
- *. Commercial and Residential Architectural lighting.
- *. Mini-accent / Uplighters / Downlighters / Orientation lighting
- *. Fiber Optic Alternative / Decorative / Entertainment lighting.
- *. Security / Garden lighting.
- *. Cove / Undershef / Task lighting.
- *. Traffic signaling / Beacons / Rail crossing and Wayside lighting.
- *. Decorative.
- *. Sign and channel Letter.

Dimension

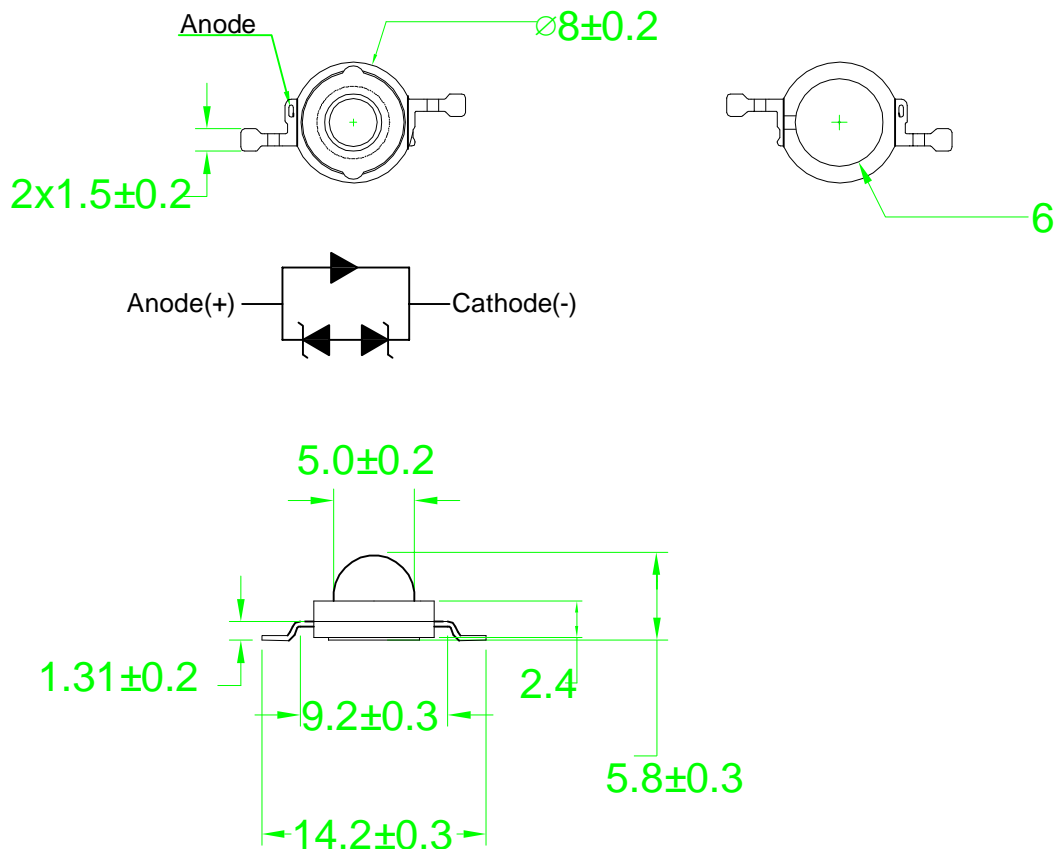

Note:1.All dimension are in millimeter
2.Specifications are subject to change without notice

Absolute Maximum Ratings at Ta=25°C

Parameter	Symbol	Ratings	UNIT
		Blue	
DC Forward Current	IF	350	mA
Power Dissipation	PD	1.05	W
Peak pulse current Duty 1/10@10KHz	IFP	500	mA
LED junction Temperature	Tj	125	°C
Reverse Current(VR=5V)	Ir	100	μA
Storage Temperature	Tstg	-40 ~ +120	°C
Operating Temperature	Topr	-40 ~ +100	°C
Manual Soldering Time at 260°C(Max)	Tsol	5	seconds

Luminous Flux Characteristics at 350mA (Ratings At 25°C Ambient)

Radiation Pattern	PART NO	Emission Color	Luminous Flux @350mA(lm)			Units
			Min.	Typ.	Max.	
Lambertian	LGFLB-321E-60	Blue	6.3	10.7	----	lm

Forward Voltage Characteristics at 350mA

(Ratings At 25°C Ambient)

Radiation Pattern	PART NO	Emission Color	Vf			Units
			Min.	Typ.	Max.	
Lambertian	LGFLB-321E-60	Blue	3.0	3.6	4.0	V

Note : Forward Voltage is measured with an accuracy of $\pm 0.1V$

Dominant Wavelength Characteristics at 350mA

(Ratings At 25°C Ambient)

Radiation Pattern	PART NO	Emission Color	λD			Units
			Min.	Typ.	Max.	
Lambertian	LGFLB-321E-60	Blue	450	----	462	nm

Temperature Coefficient Of Forward Voltage & Thermal Resistance Junction To Board Characteristics at 350mA

(Ratings At 25°C Ambient)

Radiation Pattern	PART NO	Emission Color	$\Delta Vf/\Delta T$		Rth,j-B	
			Typ.	Units	Typ.	Units
Lambertian	LGFLB-321E-60	Blue	-2	mV/°C	18	°C/W

Emission Angle Characteristics at 350mA

(Ratings At 25°C Ambient)

PART NO	Emission Color	Lambertian	Units
LGFLB-321E-60	Blue	60	Degrees

Brightness Code For High Power LED

Group	Luminous flux(lm)	
	Min	Max
F15	6.3	8.2
F16	8.2	10.7
F17	10.7	13.9
F18	13.9	18.1

Note : Flux is measured with an accuracy of $\pm 10\%$

Dominant Wavelength For High Power LED

Group		λD (nm)	
		Min	Max
B	OI	450	453
	OH	453	456
	OG	456	459
	OF	459	462

Recommended Solder Pad Design

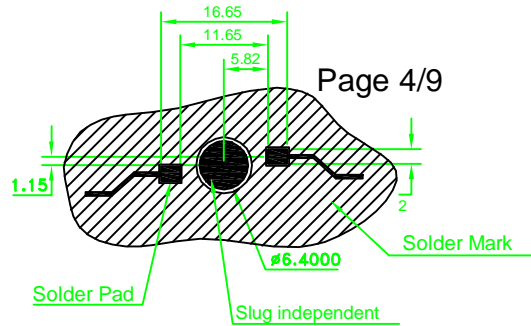
**NOTE:**

1. All dimensions are in mm.
2. The drawings are not to scale.
3. Solder pad can't be connected to slug.

Precautions For Use:**Storage :**

1. The operation of Temperatures and RH are : 5 °C ~35 °C ,RH60%,After the package is opened, LEDs should be stored at temperatures less than 30 °C and humidity less than 30%.
2. Once the package is opened, the products should be used within a week. Otherwise, they should be kept in a damp proof box with desiccating agent. Considering the products life, we suggest our customers to use our products within a year(from production date).
3. If opened more than one week in an atmosphere 5 °C ~ 35 °C ,RH60%, they should be treated at 60 °C ±5 °C for 6hrs.

Manual Hand Soldering

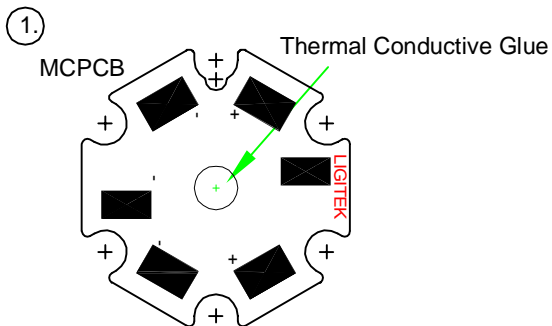

Place Thermal Comductive Glue on the MCPCB.

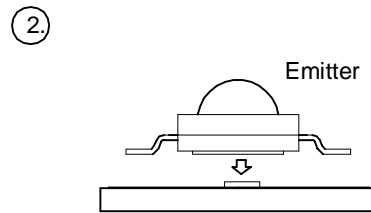

Place Emitter on the MCPCB.

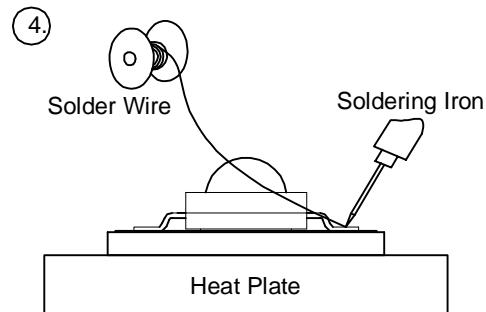
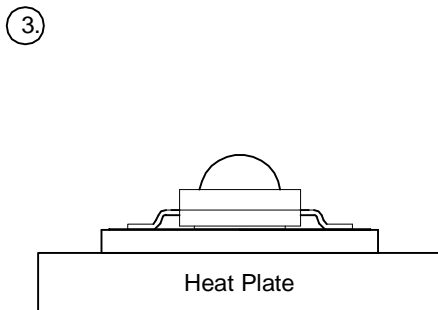

Use Soldering Iron to solder the leads of Emitter within 5 seconds.

Handling Precaution:

1. For prototype builds or small series production runs it possible to place and solder the emitters by hand.
2. Solder tip temperature : 230°C max for Lead Solder and 260°C max for Lead-Free Solder.
3. Avoiding damage to the emitter or to the MCPCB dielectric layer. Damage to the epoxy layer can cause a short circuit in the array.
4. Do not let the solder contact from solder pad to back-side of MCPCB. This one will cause a short circuit and damage emitter.
5. Avoid leaving fingerprints or scratches (by sharp tools) on the silicone resin parts.
6. Do not force over 2000gf impact or pressure on the silicone molding lens.
7. The LEDs should only be picked up by making contact with the sides of the LED body.
8. When populating in SMT production, the pick-and-place nozzle must not place excessive pressure on the silicone molding lens.



Fig.1 Forward current vs. Forward Voltage

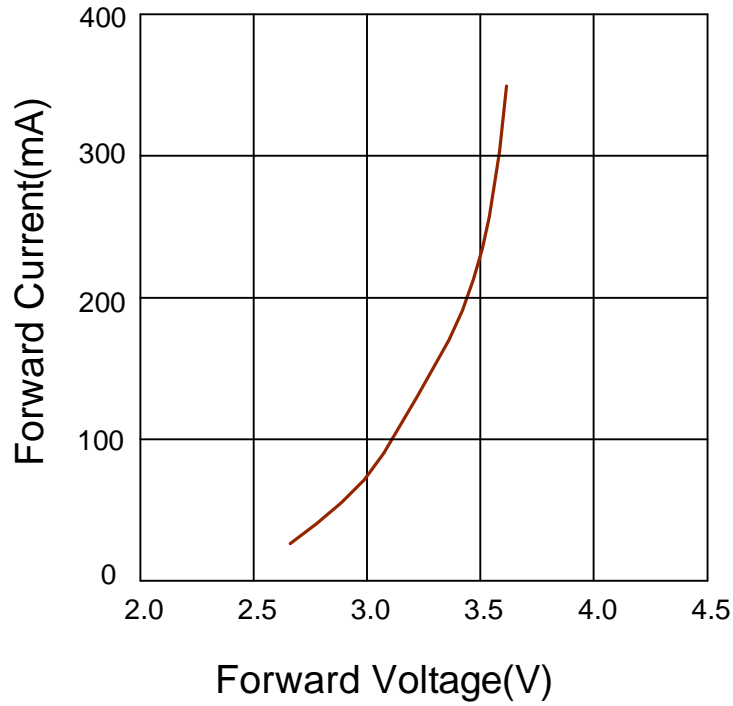

Fig.2 Operating current vs. Ambient Temperature

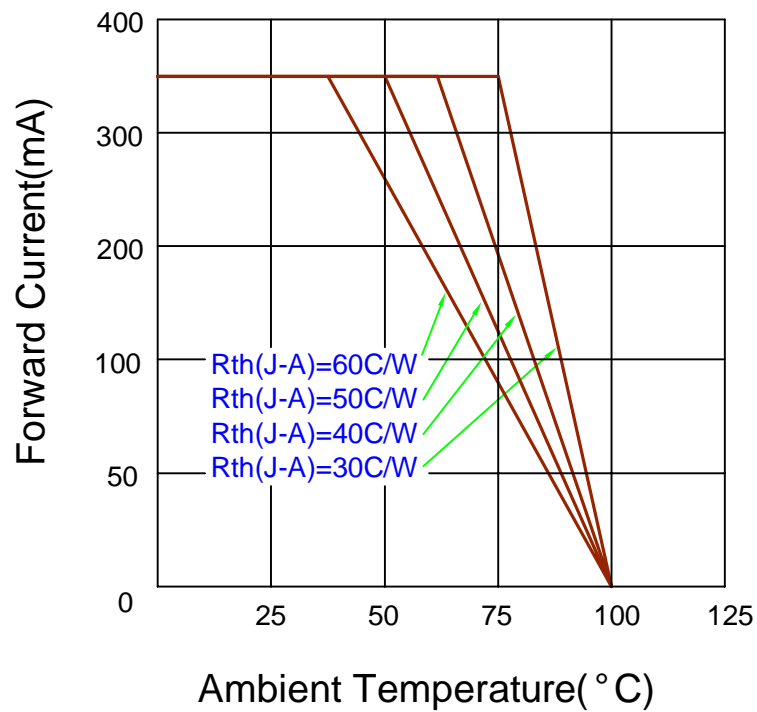

Fig.3 Forward current vs. Luminous Flux

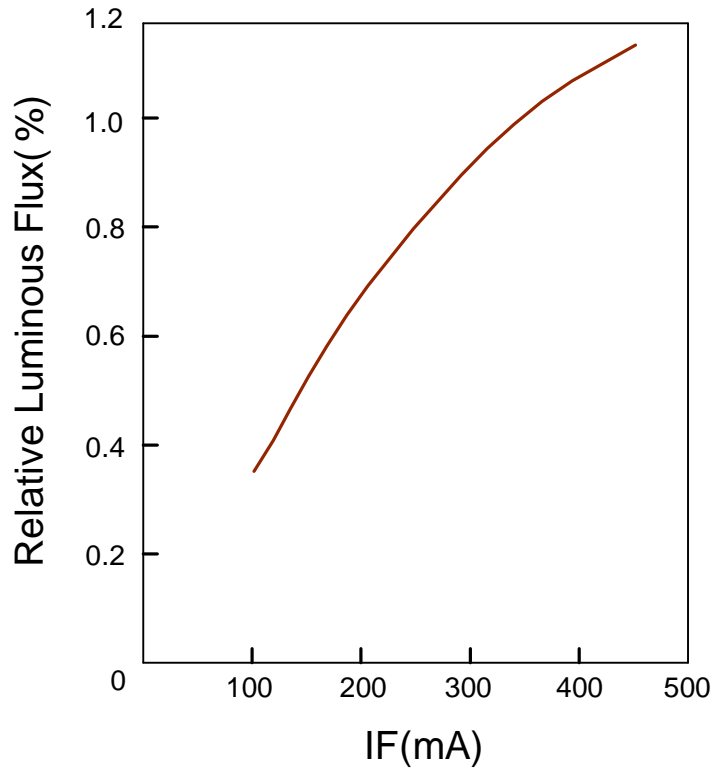

Fig.4 Junction Temperature vs. Forward Voltage

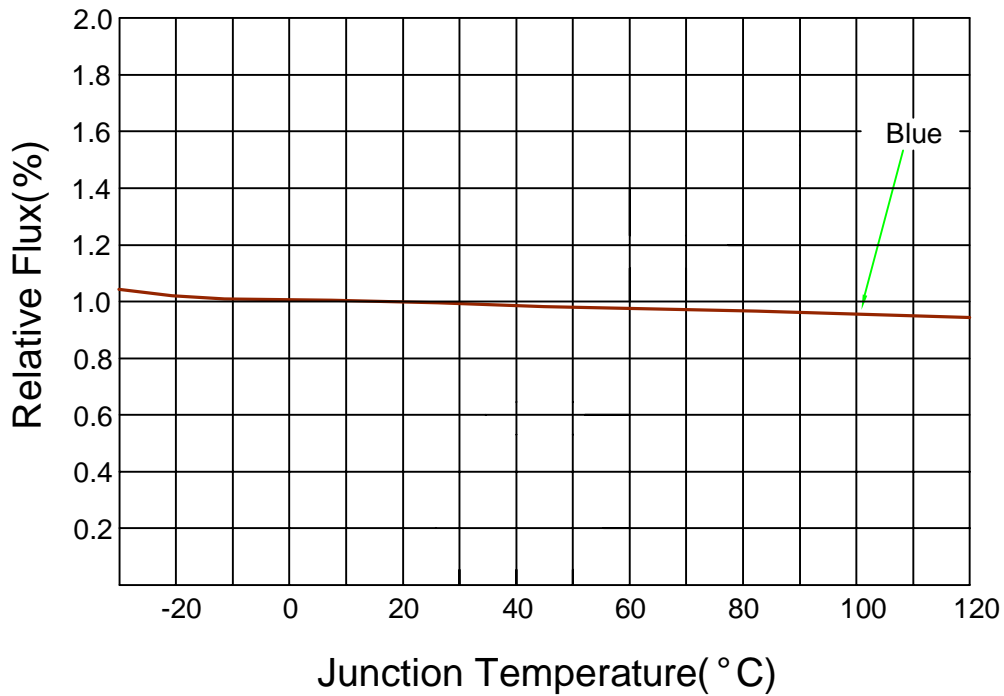

Fig.5 Relative Luminous Flux vs. Wavelength

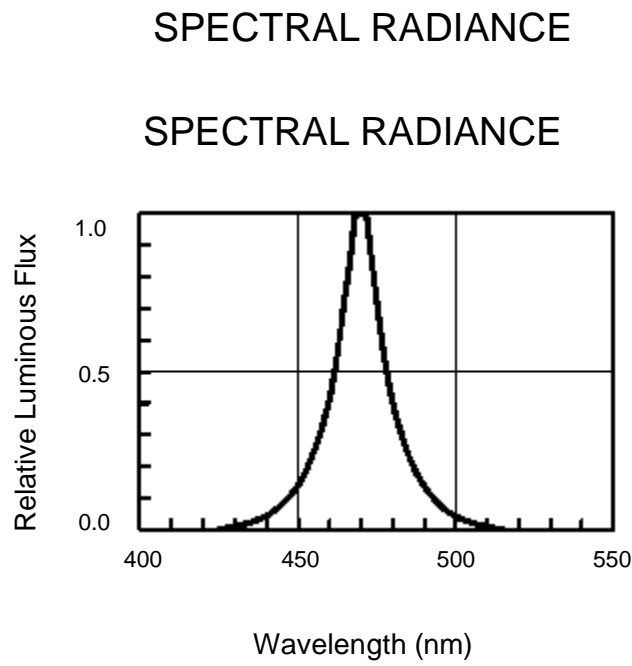
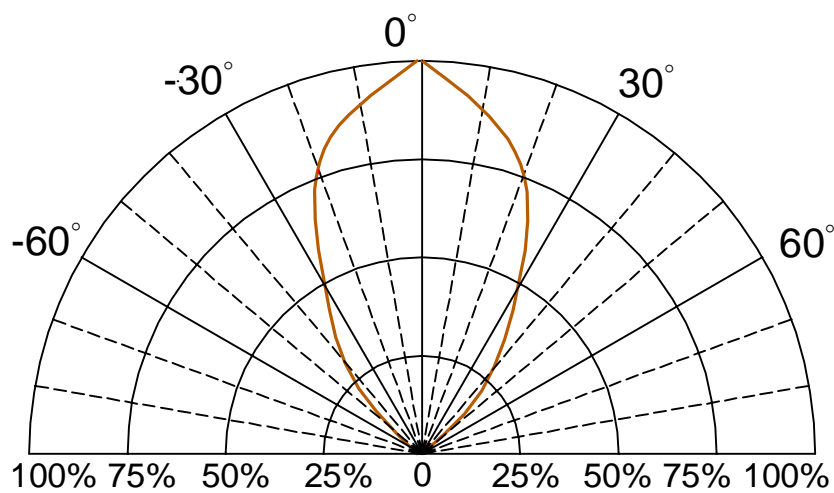
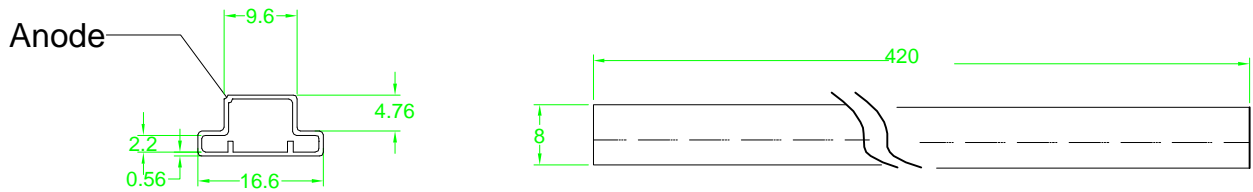

Fig.6 Directivity Radiation



PACKING SPECIFICATION

1. 50PCS / TUBE



2. 20 TUBES / INNER BOX (10*2)

SIZE : L X W X H 460cm X 110cm X 60cm

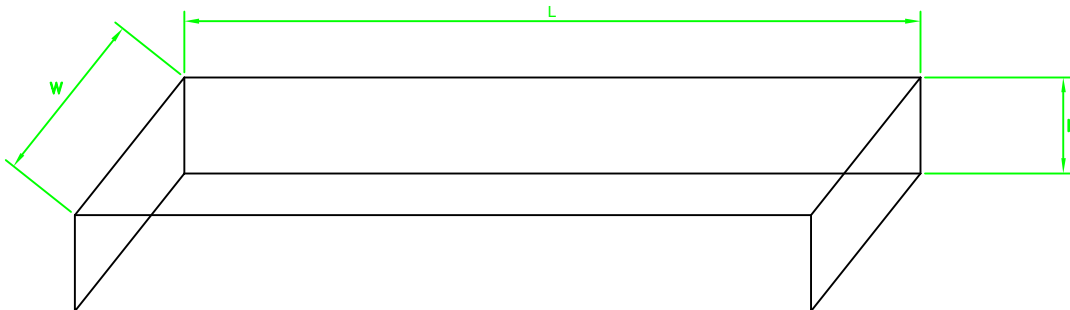

3. 10 INNER BOXES / CARTON

SIZE : L X W X H 480cm X 240cm X 325cm

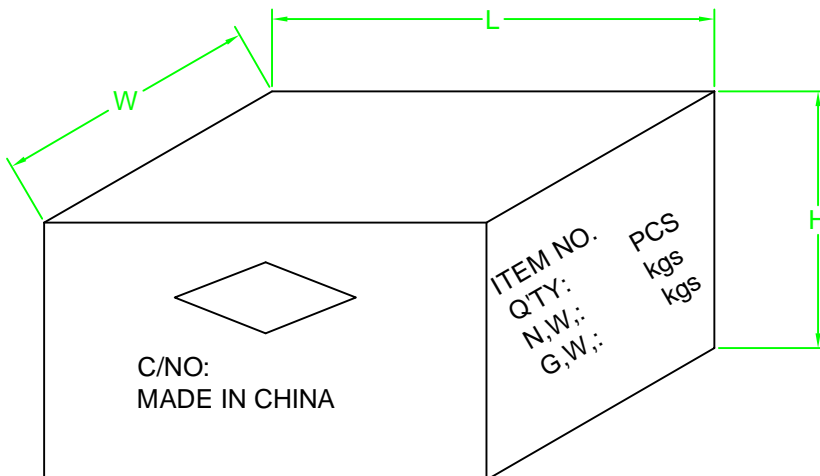

Recommended Soldering Conditions

1. PB-Free Reflow Solder

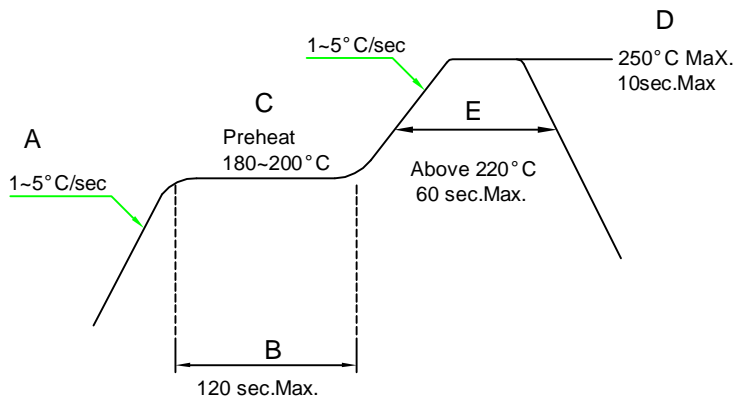

Reflow Soldering should not be done more than two times.

Solder Reflow Process Parameters:

1.Reflow soldering of Helixeon emitters requires effective control of heating and cooling. Both the rate of heating and cooling and the absolute temperatures reached are critical in assuring the formation of a reliable solder joint while avoiding damage to the emitter during the reflow process. The recommended temperature profile of solder reflow process is shown below in the figure.

1-1. Preheat

Set the temperature rising speed A at a rate of 1~5°C/s. Careful about rapid temperature rise in preheat zone as it may cause excessive slumping of the solder paste. Appropriate preheat time B will be from 60 to 120 seconds. If the preheat is insufficient, rather large solder balls tend to be generated. Conversely, if performed excessively, fine balls and large balls will generate in clusters at a time. Appropriate preheat ending temperature C will be from 180 to 200°C. If the temperature is too low, non-melting tends to be caused in the area with large heat capacity after reflow.

1-2. Heating

Careful about sudden rise in temperature as it may worsen the slump of solder paste. Set the peak temperature D in the range from 220 to 250°C. Adjust the melting time that the time over 220°C, E, will be from 30 to 60 seconds.

1-3. Cooling

Careful about slow cooling as it may cause the positional shift of parts and decline in joining strength at times.

Reliability Test

Item	Description	Stress Condition	Test Duration
RTOL	Room Temperature Operation Life	25° C, Max. IF	1000 hours
WHT	Wet High Temperature	85° C/85%RH	1000 hours
TC	Temperature Cycling	-40/+110° C, 30min dwell,<5min trans.	200 cycles
TS	Thermal Shock	-40/+110° C, 20min dwell,<20min trans.	200 cycles
HTSL	High Temperature Storage Life	120° C	1000 hours
LTSL	Low Temperature Storage Life	-40° C	1000 hours
SHR	Solder Heat Resistance	260±5° C, 5secs	
MS	Mechanical Shock	1500G,0.5msec pulse, 5 shocks each 6 axis	
ND	Natural Drop	On concrete from 1.2m, 3times	
RV	Random Vibration	6G RMS from 10 to 2KHz, 10mins/axis	
VVF	Variable Vibration Frequency	10-2000-10Hz, 20G 1 min, 1.5mm, 3timesx/axis	

Note :

Failure criteria:

Electrical failures

V_F shife $\geq 10\%$

$I_R < 50\mu A @ V_r = 5v$

Ligitek output Degradation

%lv shift $\geq 30\% @ 1000hrs$ or 200cycle

Visual failures

Broken or damaged pockage or lead

Dimension out of tolerance