



ON Semiconductor®

<http://onsemi.com>

STK672-210-E

Thick-Film Hybrid IC

Unipolar Constant-Current Chopper Two-Phase Stepping Motor Driver Output Current 1.4A

Overview

The STK672-210-E is two-phase stepping motor driver hybrid IC (HIC) that features further miniaturization and improved input logic flexibility as compared to the STK6712 series products.

Applications

- The STK672-210-E is optimal for use as a stepping motor driver in printers, copiers, XY plotters, and similar equipment.

Features

- Built-in common-mode input protection circuit.
- The input signal logic lines are provided as active-high and active-low pairs, and thus support switching the motor wiring.
- Built-in current detection resistor for reduced external component mounting area on the printed circuit board.
- Wide motor operating range (10 to 45V)

STK672-210-E

Specifications

Absolute Maximum Ratings at $T_c = 25^\circ\text{C}$

Parameter	Symbol	Conditions	Ratings	Unit
Maximum supply voltage 1	V_{CC1} max	No signal	52	V
Maximum supply voltage 2	V_{CC2} max	No signal	-0.3 to +7.0	V
Input voltage	V_{IN} max	Logic input pins	-0.3 to +7.0	V
Output current	I_{OH} max	0.5s, 1 pulse, when V_{CC1} is applied	2.2	A
Allowable power dissipation	P_d max	With an arbitrarily large heat sink. Per MOSFET	6.5	W
Operating substrate temperature	T_c max		105	$^\circ\text{C}$
Junction temperature	T_j max		150	$^\circ\text{C}$
Storage temperature	T_{stg}		-40 to +125	$^\circ\text{C}$

Stresses exceeding Maximum Ratings may damage the device. Maximum Ratings are stress ratings only. Functional operation above the Recommended Operating Conditions is not implied. Extended exposure to stresses above the Recommended Operating Conditions may affect device reliability.

Allowable Operating Ranges at $T_a = 25^\circ\text{C}$

Parameter	Symbol	Conditions	Ratings	Unit
Supply voltage 1	V_{CC1}	With signals applied	10 to 45	V
Supply voltage 2	V_{CC2}	With signals applied	$5.0 \pm 5\%$	V
Input voltage	V_{IH}		0 to V_{CC2}	V
Phase driver withstand voltage	V_{DSS}	$I_D = 1\text{mA}$ ($T_c = 25^\circ\text{C}$)	100	V
Output current 1	I_{OH1}	When the pin 6 to 9 signals are $\geq 100\text{Hz}$, $T_c = 105^\circ\text{C}$, 50% duty	1.4	A
Output current 2	I_{OH2}	When the pin 6 to 9 signals are $\geq 100\text{Hz}$, $T_c = 90^\circ\text{C}$, 50% duty	1.6	A

Electrical Characteristics at $T_c = 25^\circ\text{C}$, $V_{CC1} = 24\text{V}$, $V_{CC2} = 5\text{V}$

Parameters	Symbols	Conditions	Rating			unit
			min	typ	max	
Control supply current	I_{CCO}	With all inputs at the V_{CC2} level		3.3	10	mA
Output average current	I_{oave}	With $R/L = 3.5\Omega/3.8\text{mH}$ in each phase	0.405	0.450	0.505	A
FET diode forward voltage	V_{df}	$I_f = 1.0\text{A}$		1.1	1.8	V
Output saturation voltage	V_{sat}	$R_L = 24\Omega$		0.8	1.2	V
V_{ref} input voltage	V_{rH}	Pin 12	0		3.5	V
V_{ref} input bias current	I_{IB}	With pin 12 at 1V		50	500	nA
[Control Input Pins]						
Input voltage	V_{IH}	HIC pins 6 to 9	3.5			V
	V_{IL}	HIC pins 6 to 9			0.7	V
Input current	I_{IH}	HIC pins 6 to 9, $V_{IN} = V_{CC2}$		310		μA
	I_{IL}	HIC pins 6 to 9, $V_{IN} = 0\text{V}$		2.5		μA

Note: A fixed-voltage power supply must be used.

Package Dimensions

unit:mm (typ)

4168

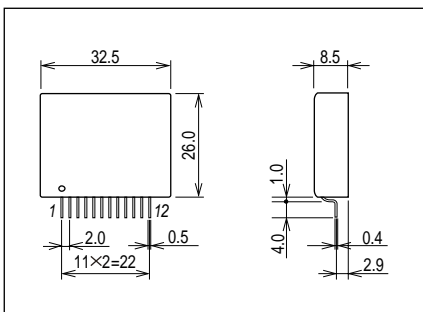

STK672-210-E

Internal Block Diagram

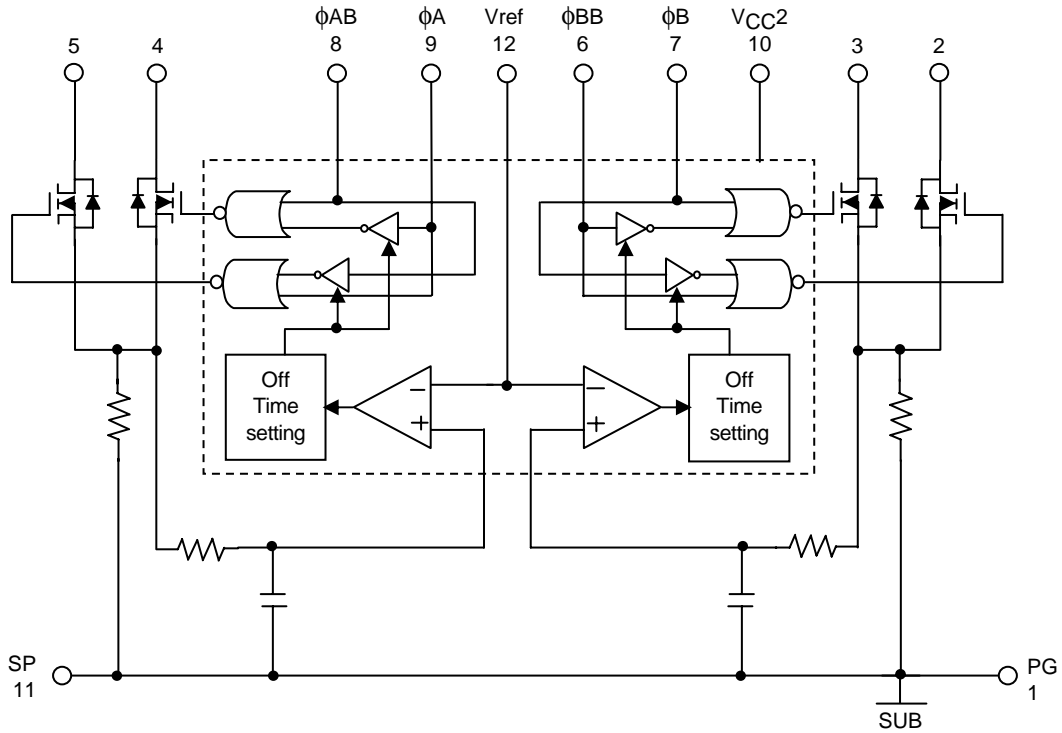

Sample Application Circuit

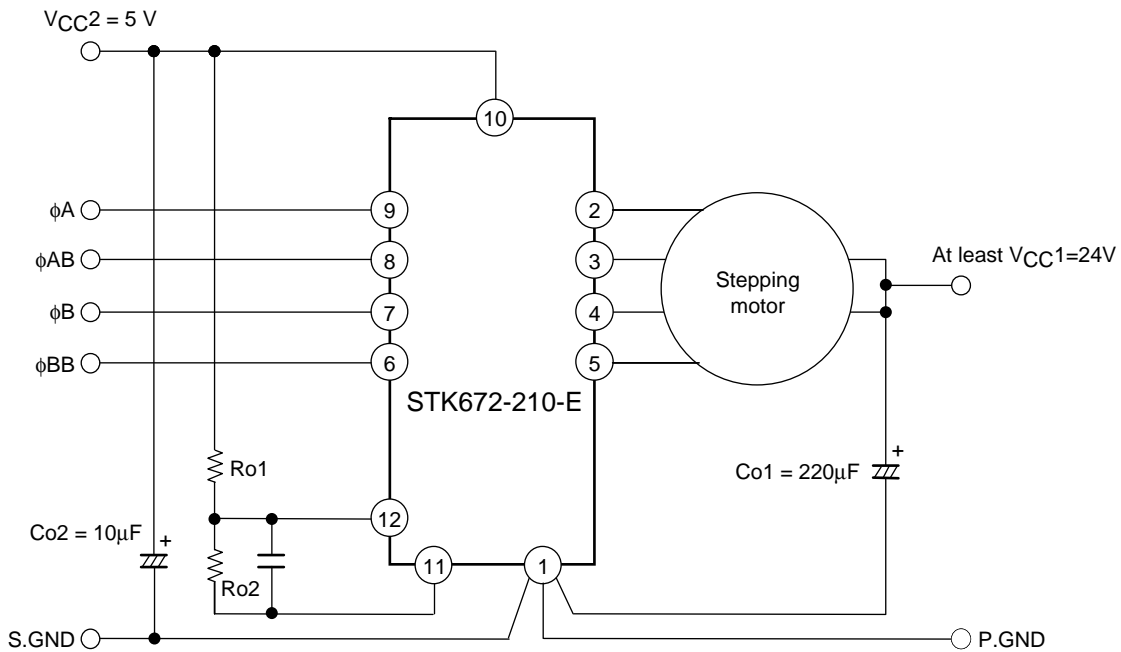

ITF02289

- The Co1 ground lead must be connected as close as possible to pin 1 on the hybrid IC.
- HC type CMOS levels are recommended as the input specifications for pins 6 to 9.
- In case of TTL input, connect a pull-up resistor. (Recommended value: 2kΩ)
- Excitation control input specifications

Corresponding output pin	Corresponding excitation control input signal	
	Active: High	Active: Low
2 pin	φB	φBB
3 pin	φBB	φB
4 pin	φA	φAB
5 pin	φAB	φA

Setting the Motor Current Peak Value (I_{OH})

$$I_{OH} \approx V_{ref} \div R_s$$

V_{ref}: STK672-210-E pin 12 input voltage

R_s: STK672-210-E internal current detection resistor (0.195Ω ±2%)

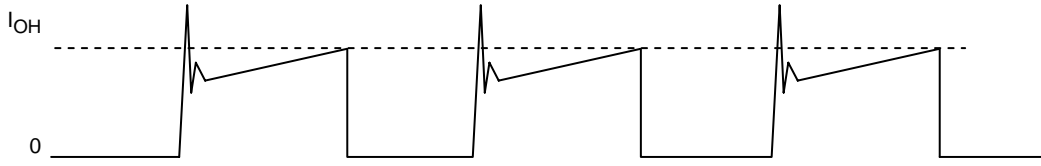

Model of the Motor Current Flowing into the Driver IC (pins 2, 3, 4, and 5)

$$V_{ref} = (R_{o2} \div (R_{o1} + R_{o2})) \times V_{CC2}$$

$$V_{CC2} = 5V$$

Current Switching Techniques

Due to the input bias current (I_{IB}) specifications, R_{o1} must be under 100kΩ.

The figures below present sample circuits that temporarily switch the motor current when, for example a held motor stops.

We recommend using the circuit structure in the figure at the left to minimize as much as possible the effects of the saturation voltage of the reference voltage switching transistor.

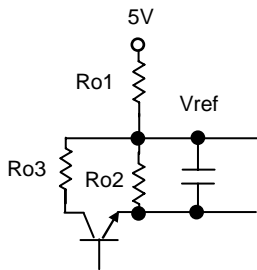

Switching Circuit 1

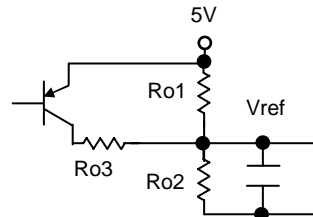

Switching Circuit 2

Input Pin Circuits

Input pin	Circuit type
Pin 6, 7, 8, and 9	<p>The 5V/GND switch shows how toff time setting operates in the internal block diagram on page 3. When switched to GND, pull-down with an input resistance of 20kΩ is formed.</p>
Pin 12	<p>To one of the comparator</p>

Thermal Design

The size of the heat sink required for the STK672-210-E depends on the output current I_{OH} (A), the electrical characteristics of the motor, the excitation mode, and the basic drive frequency.

The thermal resistance (θ_{c-a}) of the required heat sink can be determined from the following formula.

$$\theta_{c-a} = \frac{T_{c\ max} - T_a}{P_d} \text{ (}^\circ\text{C/W)}$$

$T_{c\ max}$: The STK672-210-E substrate temperature ($^\circ\text{C}$)

T_a : The STK672-210-E ambient temperature ($^\circ\text{C}$)

P_d : The average internal power dissipation in the STK672-210-E (W)

For example, the required area for a heat sink made from 2mm thick aluminum can be determined from the graph at the right below. Note that the ambient temperature is greatly influenced by the ventilation and air flow patterns within the application. This means that the size of the heat sink must be determined with care so that the STK672-210-E back surface (aluminum substrate) temperature T_c in the mounted state never exceeds, under any conditions that might occur, the temperature $T_c = 105^\circ\text{C}$.

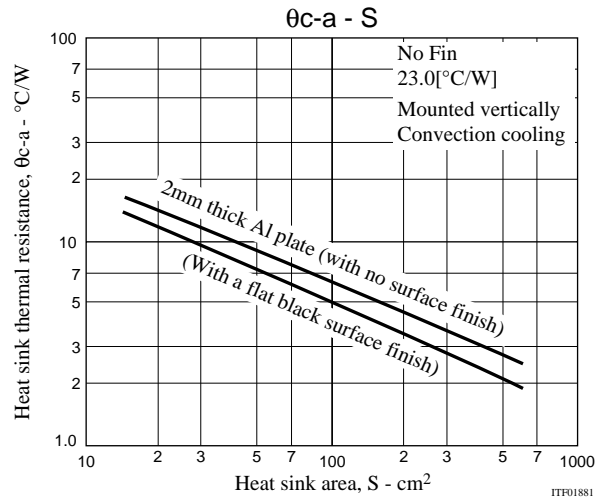
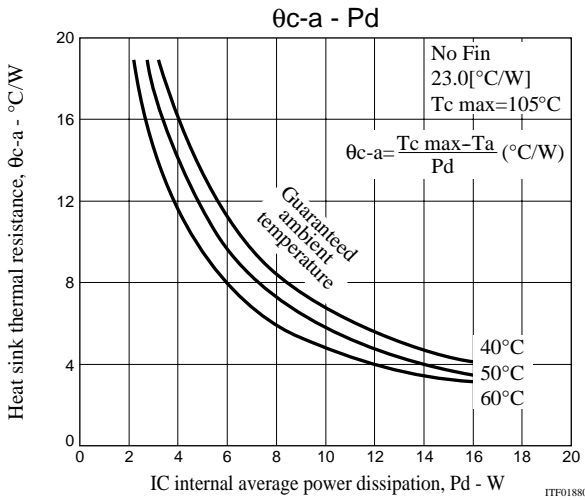

STK672-210-E Average Internal Power Dissipation P_d

Of the devices that contribute to the STK672-210-E average internal power supply, the devices with the largest power dissipation are the current control devices, the diodes that handle the regenerative current, the current detection resistor, and the predriver circuit.

The following presents formulas for calculating the power dissipation for the different excitation (drive) modes.

2 phase excitation mode

$$P_{d2EX} = (V_{sat} + V_{df}) \times 0.5 \times \text{CLOCK} \times I_{OH} \times t_2 + 0.5 \times \text{CLOCK} \times I_{OH} \times (V_{sat} \times t_1 + V_{df} \times t_3)$$

1-2 phase excitation mode

$$P_{d1-2EX} = (V_{sat} + V_{df}) \times 0.25 \times \text{CLOCK} \times I_{OH} \times t_2 + 0.25 \times \text{CLOCK} \times I_{OH} \times (V_{sat} \times t_1 + V_{df} \times t_3)$$

Motor hold mode

$$P_{dHOLDEX} = (V_{sat} + V_{df}) \times I_{OH}$$

V_{sat} : Ron voltage drop + shunt resistor combined voltage

V_{df} : FET internal diode + shunt resistor combined voltage

CLOCK: Input clock (shows clock in the timing charts on page 4)

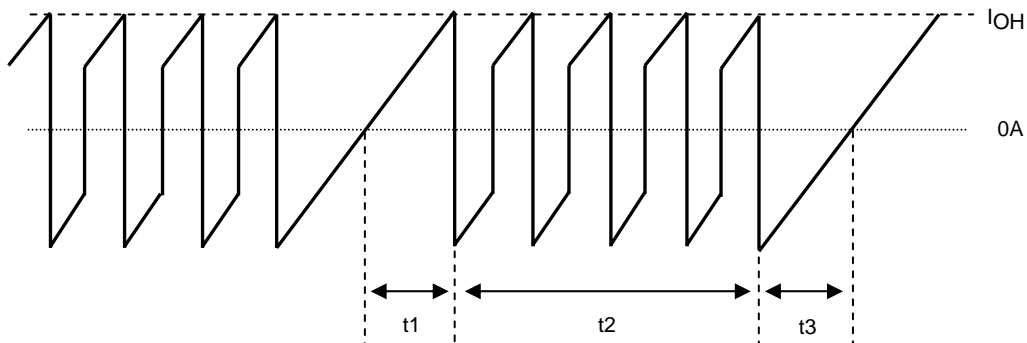

Figure 1 Motor COM current waveform model

STK672-210-E

t1: The time until the winding current reaches its rated current (I_{OH})

t2: The time in the constant-current control (PWM) region

t3: The time from the point a phase signal is cut until the back EMF current is dissipated.

$$t1 = (-L/(R + 0.77)) \ln (1 - ((R + 0.77)/V_{CC1}) \times I_{OH})$$

$$t3 = (-L/R) \ln ((V_{CC1} + 0.77) / (I_{OH} \times R + V_{CC1} + 0.77))$$

V_{CC1} : Motor supply voltage (V)

L: Motor inductance (H)

R: Motor winding resistance (Ω)

I_{OH} : Set motor output current wave height (A)

The constant-current control time t2, and the time T (= t1 + t2 + t3) that the phase signal is on in each excitation mode are as follows.

2 phase excitation mode: $t2 = (2/\text{Clock}) - (t1 + t3)$

1-2 phase excitation mode: $t2 = (3/\text{Clock}) - t1$

Determine the values for V_{sat} and V_{df} by substitution using the graphs for V_{sat} vs I_{OH} and V_{df} vs I_{OH} for the set current value for I_{OH} . Then judge whether or not a heat sink is required from the determined average power dissipation for the STK672-210-E by comparison with the ΔT_c vs. Pd graph.

Note that it is necessary to check the temperature rise in the actual application system case, since the STK672-210-E substrate temperature T_c changes with the air convection conditions around the STK672-210-E when a heat sink without fins is used.

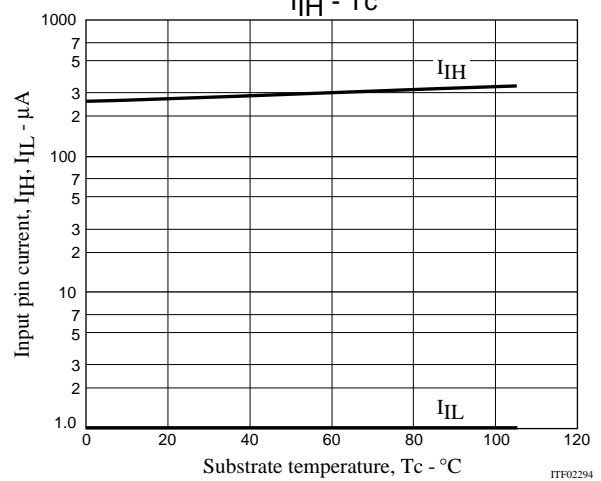
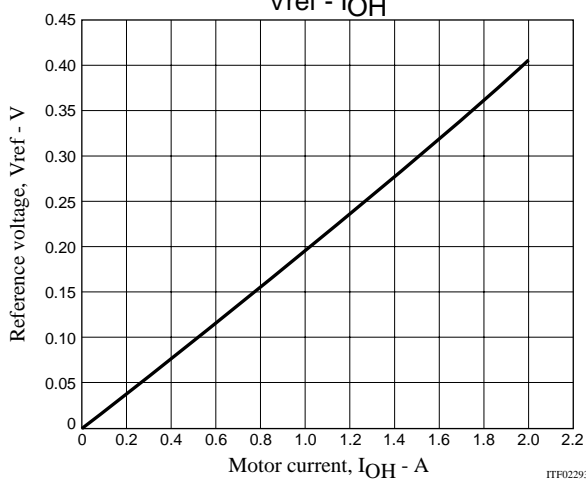
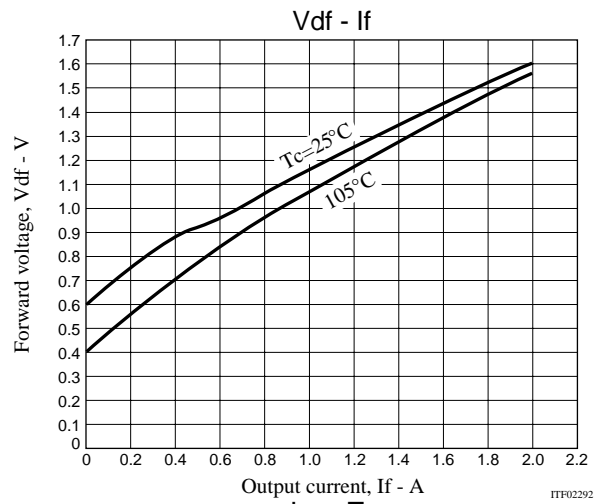
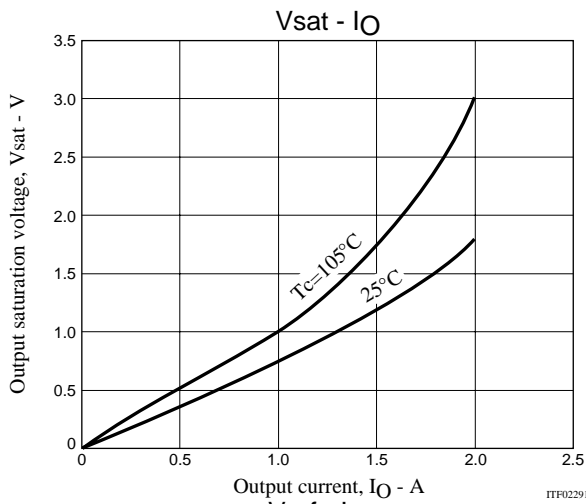

STK672-210-E

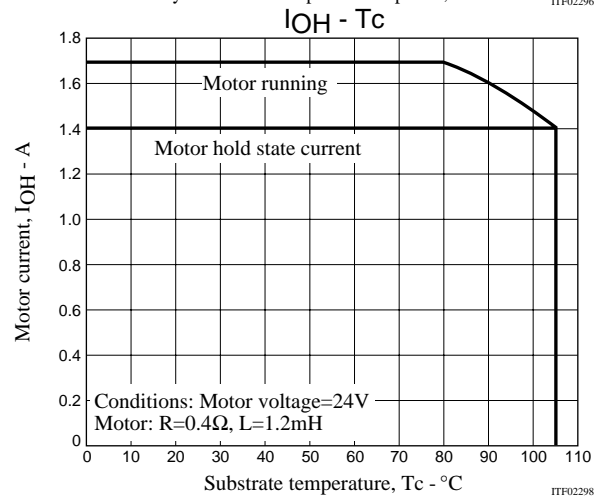
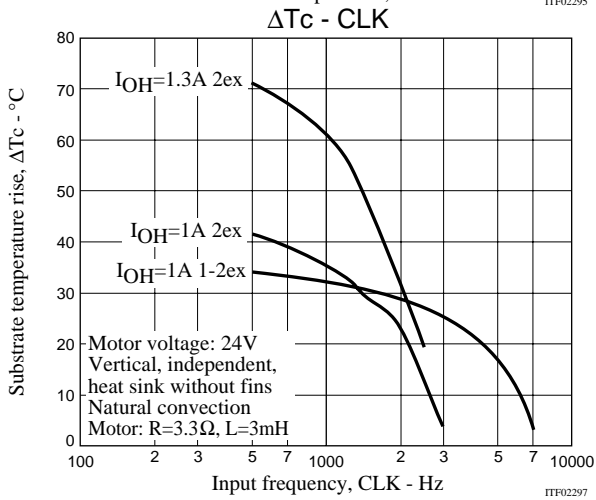
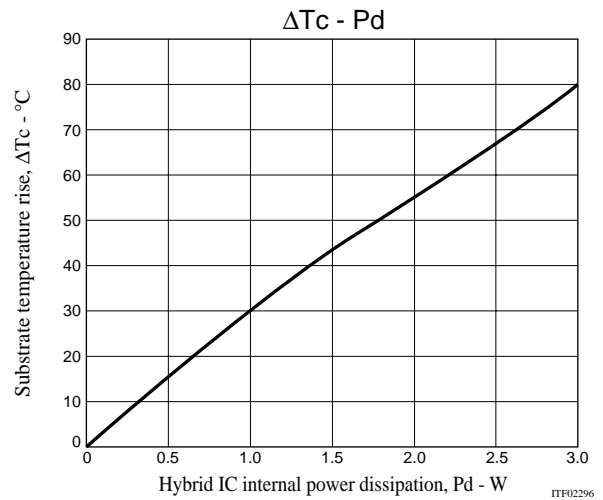
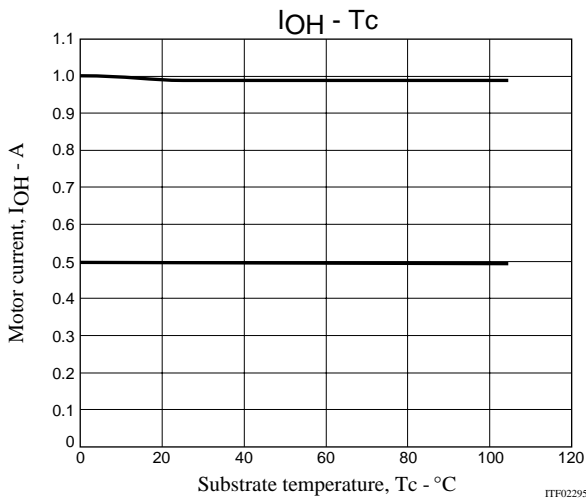

STK672-210-E Allowable Avalanche Energy Value

[Allowable Range in Avalanche Mode]

When driving a 2-phase stepping motor with constant current chopping using an STK672-2** Series hybrid IC, the waveforms shown in Figure 1 below result for the output current, I_D , and voltage, V_{DS} .

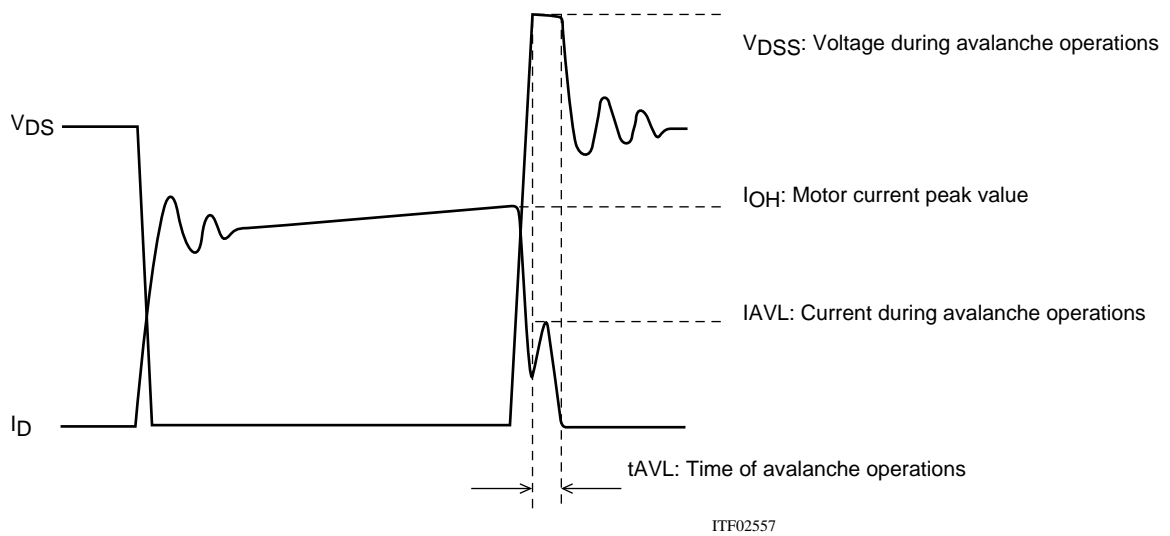

Figure 1 Output Current, I_D , and Voltage, V_{DS} , Waveforms 1 of the STK672-2** Series when Driving a 2-Phase Stepping Motor with Constant Current Chopping

STK672-210-E

When operations of the MOSFET built into STK672-2** Series ICs is turned off for constant current chopping, the I_D signal falls like the waveform shown in the figure above. At this time, the output voltage, V_{DS} , suddenly rises due to electromagnetic induction generated by the motor coil.

In the case of voltage that rises suddenly, voltage is restricted by the MOSFET V_{DSS} . Voltage restriction by V_{DSS} results in a MOSFET avalanche. During avalanche operations, I_D flows and the instantaneous energy at this time, E_{AVL1} , is represented by Equation (1).

$$E_{AVL1} = V_{DSS} \times I_{AVL} \times 0.5 \times t_{AVL} \text{ ----- (1)}$$

V_{DSS} : V units, I_{AVL} : A units, t_{AVL} : sec units

The coefficient 0.5 in Equation (1) is a constant required to convert the I_{AVL} triangle wave to a square wave.

During STK672-2** Series operations, the waveforms in the figure above repeat due to the constant current chopping operation. The allowable avalanche energy, E_{AVL} , is therefore represented by Equation (2) used to find the average power loss, P_{AVL} , during avalanche mode multiplied by the chopping frequency in Equation (1).

$$P_{AVL} = V_{DSS} \times I_{AVL} \times 0.5 \times t_{AVL} \times f_c \text{ ----- (2)}$$

f_c : Hz units (f_c is set to the PWM frequency of 50kHz.)

For V_{DSS} , I_{AVL} , and t_{AVL} , be sure to actually operate the STK672-2** Series and substitute values when operations are observed using an oscilloscope.

Ex. If $V_{DSS}=110V$, $I_{AVL}=1A$, $t_{AVL}=0.2\mu s$ when using a STK672-210-E driver, the result is:

$$P_{AVL} = 110 \times 1 \times 0.5 \times 0.2 \times 10^{-6} \times 50 \times 10^3 = 0.55W$$

$V_{DSS}=110V$ is a value actually measured using an oscilloscope.

The allowable loss range for the allowable avalanche energy value, P_{AVL} , is shown in the graph in Figure 3. When examining the avalanche energy, be sure to actually drive a motor and observe the I_D , V_{DSS} , and t_{AVL} waveforms during operation, and then check that the result of calculating Equation (2) falls within the allowable range for avalanche operations.

[I_D and V_{DSS} Operating Waveforms in Non-avalanche Mode]

Although the waveforms during avalanche mode are given in Figure 1, sometimes an avalanche does not result during actual operations.

Factors causing avalanche are listed below.

- Poor coupling of the motor's phase coils (electromagnetic coupling of A phase and AB phase, B phase and BB phase).
- Increase in the lead inductance of the harness caused by the circuit pattern of the P.C. board and motor.
- Increases in V_{DSS} , t_{AVL} , and I_{AVL} in Figure 1 due to an increase in the supply voltage from 24V to 36V.

If the factors above are negligible, the waveforms shown in Figure 1 become waveforms without avalanche as shown in Figure 2.

Under operations shown in Figure 2, avalanche does not occur and there is no need to consider the allowable loss range of P_{AVL} shown in Figure 3.

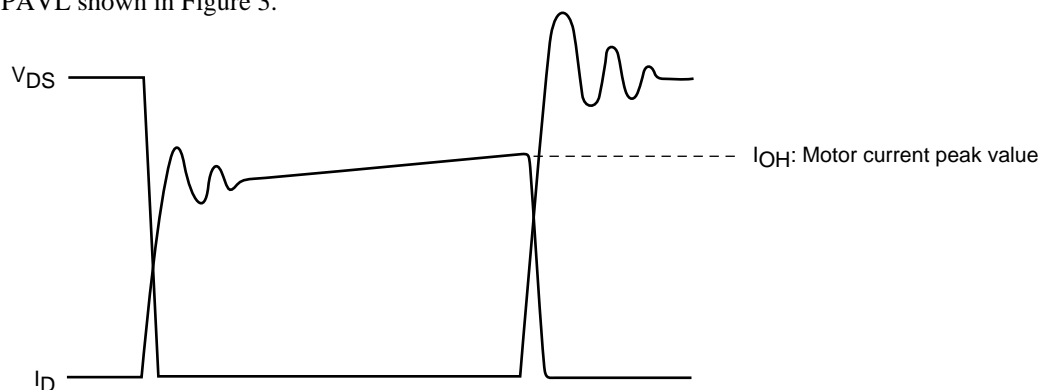

ITF02558

Figure 2 Output Current, I_D , and Voltage, V_{DS} , Waveforms 2 of the STK672-2** Series when Driving a 2-Phase Stepping Motor with Constant Current Chopping

STK672-210-E

Figure 3 Allowable Loss Range, PAVL-I_{OH} During STK672-210-E Avalanche Operations

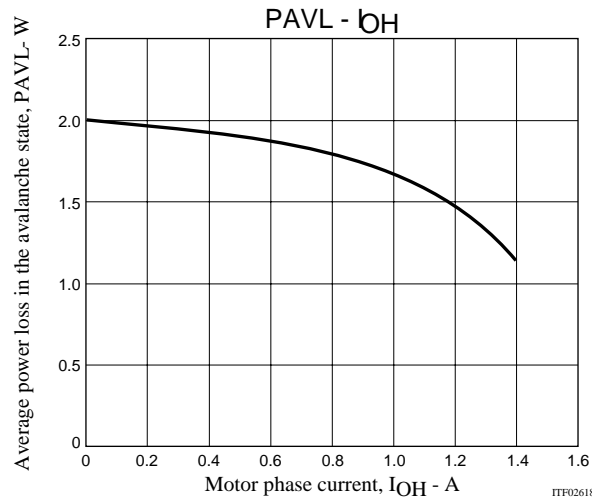

Note:

The operating conditions given above represent a loss when driving a 2-phase stepping motor with constant current chopping.

Because it is possible to apply 2W or more at I_{OH}=0A, be sure to avoid using the MOSFET body diode that is used to drive the motor as a zener diode.

[Smoke Emission Precautions]

If any of the output pins 2, 3, 4, and 5 is held open, the electrical stress onto the driver due to the inductive energy accumulated in the motor could cause short-circuit followed by permanent damage to the internal MOSFET.

As a result, the STK672-210-E may give rise to emit smoke.

ON Semiconductor and the ON logo are registered trademarks of Semiconductor Components Industries, LLC (SCILLC). SCILLC owns the rights to a number of patents, trademarks, copyrights, trade secrets, and other intellectual property. A listing of SCILLC's product/patent coverage may be accessed at www.onsemi.com/site/pdf/Patent-Marking.pdf. SCILLC reserves the right to make changes without further notice to any products herein. SCILLC makes no warranty, representation or guarantee regarding the suitability of its products for any particular purpose, nor does SCILLC assume any liability arising out of the application or use of any product or circuit, and specifically disclaims any and all liability, including without limitation special, consequential or incidental damages. "Typical" parameters which may be provided in SCILLC data sheets and/or specifications can and do vary in different applications and actual performance may vary over time. All operating parameters, including "Typicals" must be validated for each customer application by customer's technical experts. SCILLC does not convey any license under its patent rights nor the rights of others. SCILLC products are not designed, intended, or authorized for use as components in systems intended for surgical implant into the body, or other applications intended to support or sustain life, or for any other application in which the failure of the SCILLC product could create a situation where personal injury or death may occur. Should Buyer purchase or use SCILLC products for any such unintended or unauthorized application, Buyer shall indemnify and hold SCILLC and its officers, employees, subsidiaries, affiliates, and distributors harmless against all claims, costs, damages, and expenses, and reasonable attorney fees arising out of, directly or indirectly, any claim of personal injury or death associated with such unintended or unauthorized use, even if such claim alleges that SCILLC was negligent regarding the design or manufacture of the part. SCILLC is an Equal Opportunity/Affirmative Action Employer. This literature is subject to all applicable copyright laws and is not for resale in any manner.