



WR-137 Commercial Grade Straight Waveguide
 Section 6 Inch Length with UG-344/U Flange
 Operating from 5.85 GHz to 8.2 GHz

TECHNICAL DATA SHEET

PE-W137S001-6

Pasternack's waveguide sections are constructed of a high quality copper alloy designed to provide VSWR as low as 1.03:1. Waveguide sections range from WR-12 up to WR-137 and include grooved and non-grooved designs. Standard lengths of Pasternack waveguide sections range from 3" to 12" in 3" increments and each waveguide section is labeled for easy identification. Custom lengths are also available on request. Standard sections of waveguide are painted in blue and our instrumentation-grade versions are gold plated.

- WR-12 to WR-137 Waveguide Sections
- Grooved and Non-Grooved Flanges Available
- Sections Covering Frequencies from 5.8 to 90 GHz
- E-Bends, H-Bends, Filters, Terminations and Waveguide to Coax adapters are also available
- Custom lengths are also available on request

Electrical Specifications

Description	Minimum	Typical	Maximum	Units
Frequency Range	5.85		8.2	GHz
VSWR		1.03:1		
Insertion Loss		0.1 [0.33]		dB/ft [dB/m]

Mechanical Specifications

Waveguide Size: WR-137
 Waveguide Design: Commercial Grade
 Section Length: 6 in [152.4 mm]

Description	Flange 1	Waveguide	Flange 2
Interface	UG-344/U	WR-137	UG-344/U
Material	Copper Alloy	Copper Alloy	Copper Alloy
Plating	Paint	Paint	Paint
Color	Blue	Blue	Blue

Compliance Certifications (visit www.Pasternack.com for current document)

RoHS Compliant

Notes:

- Values at +25 °C, sea level

Click the following link (or enter part number in "SEARCH" on website) to obtain additional part information including price, inventory and certifications: [WR-137 Commercial Grade Straight Waveguide Section 6 Inch Length with UG-344/U Flange Operating from 5.85 GHz to 8.2 GHz PE-W137S001-6](#)





WR-137 Commercial Grade Straight Waveguide
Section 6 Inch Length with UG-344/U Flange
Operating from 5.85 GHz to 8.2 GHz

TECHNICAL DATA SHEET

PE-W137S001-6

Power Data

Outline Drawing

WR-137	
PN	Length
PE-W137S001-3	3 in.
PE-W137S001-6	6 in.
PE-W137S001-9	9 in.
PE-W137S001-12	12 in.

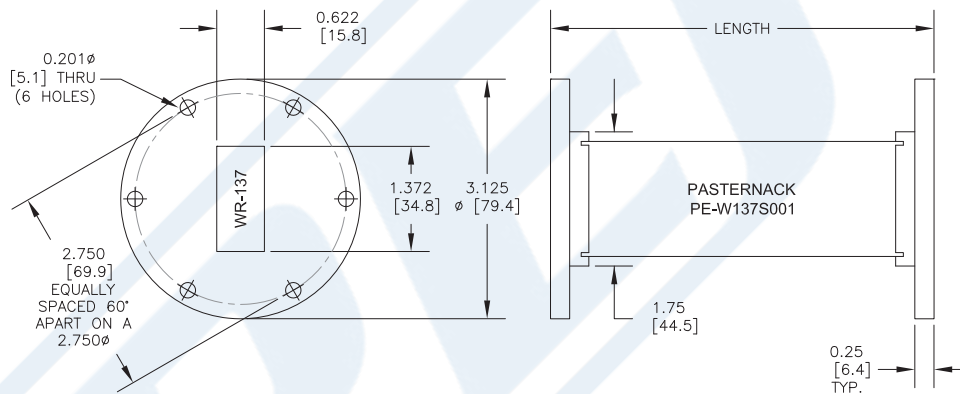

WR-137 Commercial Grade Straight Waveguide Section 6 Inch Length with UG-344/U Flange Operating from 5.85 GHz to 8.2 GHz from Pasternack Enterprises has same day shipment for domestic and International orders. Our RF, microwave and millimeter wave products maintain a 99% availability and are part of the broadest selection in the industry.

Click the following link (or enter part number in "SEARCH" on website) to obtain additional part information including price, inventory and certifications: [WR-137 Commercial Grade Straight Waveguide Section 6 Inch Length with UG-344/U Flange Operating from 5.85 GHz to 8.2 GHz PE-W137S001-6](http://www.pasternack.com/wr-137-straight-waveguide-section-ug344u-flange-5.85-8.2-ghz-pe-w137s001-6)

URL: <http://www.pasternack.com/wr-137-straight-waveguide-section-ug344u-flange-5.85-8.2-ghz-pe-w137s001-6-p.aspx>

The information contained in this document is accurate to the best of our knowledge and representative of the part described herein. It may be necessary to make modifications to the part and/or the documentation of the part, in order to implement improvements. Pasternack reserves the right to make such changes as required. Unless otherwise stated, all specifications are nominal. Pasternack does not make any representation or warranty regarding the suitability of the part described herein for any particular purpose, and Pasternack does not assume any liability arising out of the use of any part or documentation.

