

HX424C12PBK4/32

32GB (8GB 1G x 64-Bit x 4 pcs.)
 DDR4-2400 CL13 288-Pin DIMM



DESCRIPTION

HyperX HX424C12PBK4/32 is a kit of four 1G x 64-bit (8GB) DDR4-2400 CL12 SDRAM (Synchronous DRAM) 2Rx8, memory module, based on sixteen 512M x 8-bit FBGA components per module. Each module kit supports Intel® Extreme Memory Profiles (Intel® XMP) 2.0. Total kit capacity is 32GB. Each module has been tested to run at DDR4-2400 at a low latency timing of 12-13-13 at 1.35V. The SPDs are programmed to JEDEC standard latency DDR4-2133 timing of 15-15-15 at 1.2V. Each 288-pin DIMM uses gold contact fingers. The JEDEC standard electrical and mechanical specifications are as follows:

XMP TIMING PARAMETERS

- JEDEC: DDR4-2133 CL15-15-15 @1.2V
- XMP Profile #1: DDR4-2400 CL12-13-13 @1.35V
- XMP Profile #2: DDR4-2133 CL13-13-13 @1.2V

SPECIFICATIONS

CL(IDD)	15 cycles
Row Cycle Time (tRCmin)	46.5ns(min.)
Refresh to Active/Refresh Command Time (tRFCmin)	260ns(min.)
Row Active Time (tRASmin)	33ns(min.)
Maximum Operating Power	TBD W*
UL Rating	94 V - 0
Operating Temperature	0° C to +85° C
Storage Temperature	-55° C to +100° C

*Power will vary depending on the SDRAM used.

FEATURES

- Power Supply: VDD=1.2V Typical
- VDDQ = 1.2V Typical
- VPP - 2.5V Typical
- VDDSPD=2.2V to 3.6V
- Nominal and dynamic on-die termination (ODT) for data, strobe, and mask signals
- Low-power auto self refresh (LPASR)
- Data bus inversion (DBI) for data bus
- On-die VREFDQ generation and calibration
- Dual-rank
- On-board I2 serial presence-detect (SPD) EEPROM
- 16 internal banks; 4 groups of 4 banks each
- Fixed burst chop (BC) of 4 and burst length (BL) of 8 via the mode register set (MRS)
- Selectable BC4 or BL8 on-the-fly (OTF)
- Fly-by topology
- Terminated control command and address bus
- Height 2.167" (55.05mm), w/heatsink

Continued >>

MODULE WITH HEAT SPREADER

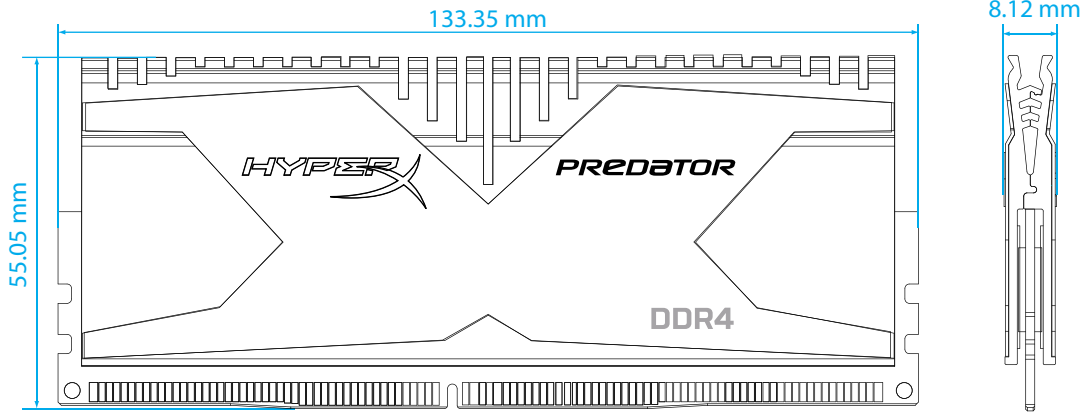

MODULE DIMENSIONS

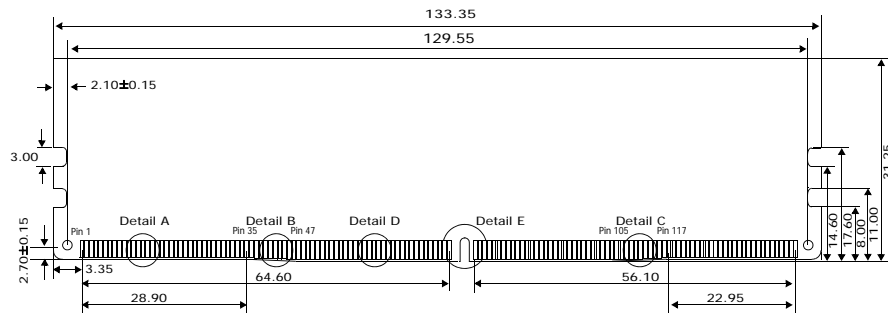
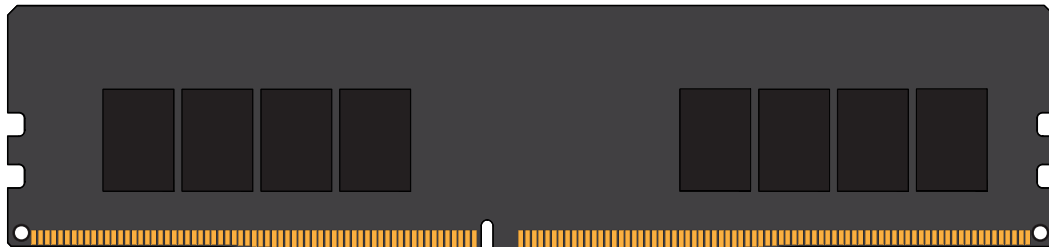
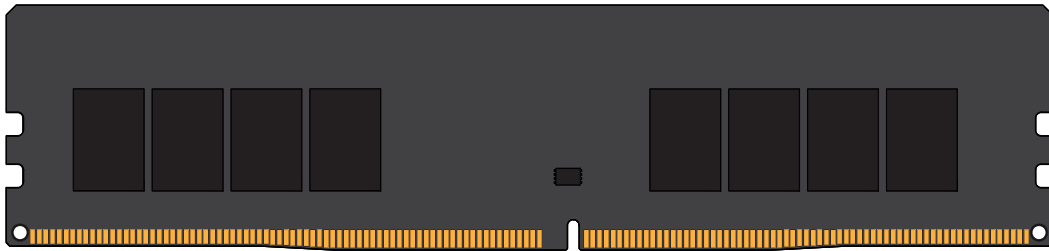

FOR MORE INFORMATION, GO TO WWW.KINGSTON.COM/HYPERX

All Kingston products are tested to meet our published specifications. Some motherboards or system configurations may not operate at the published HyperX memory speeds and timing settings. Kingston does not recommend that any user attempt to run their computers faster than the published speed. Overclocking or modifying your system timing may result in damage to computer components.