

N-Channel Enhancement Mode Power MOSFET

MTE09N06FP

BV _{DSS}	60V
I _D @ V _{GS} =10V, T _C =25°C	52A
R _{DS(on)(TYP)} @ V _{GS} =10V, I _D =30A	7.4mΩ
R _{DS(on)(TYP)} @ V _{GS} =7V, I _D =20A	8.1mΩ

Features

- Low Gate Charge
- Simple Drive Requirement
- Repetitive Avalanche Rated
- Fast Switching Characteristic
- RoHS compliant package

Symbol

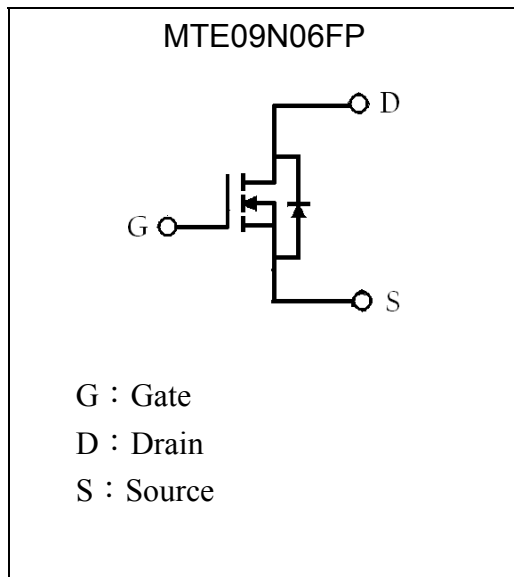

Outline

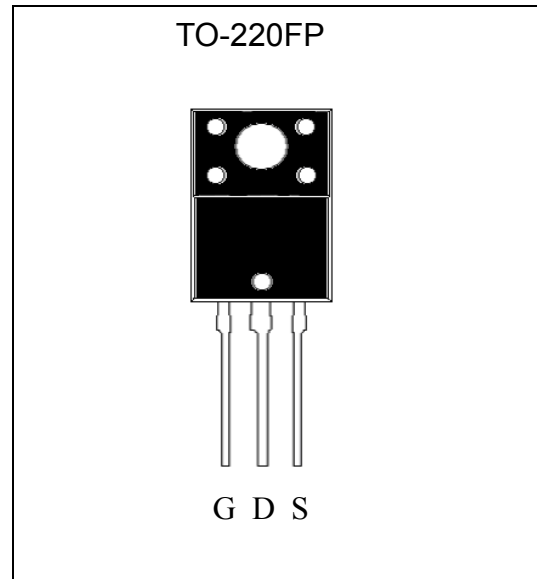

Ordering Information

Device	Package	Shipping
MTE09N06FP-0-UB-S	TO-220FP (Pb-free lead plating package)	50 pcs/tube, 20 tubes/box, 4 boxes / carton

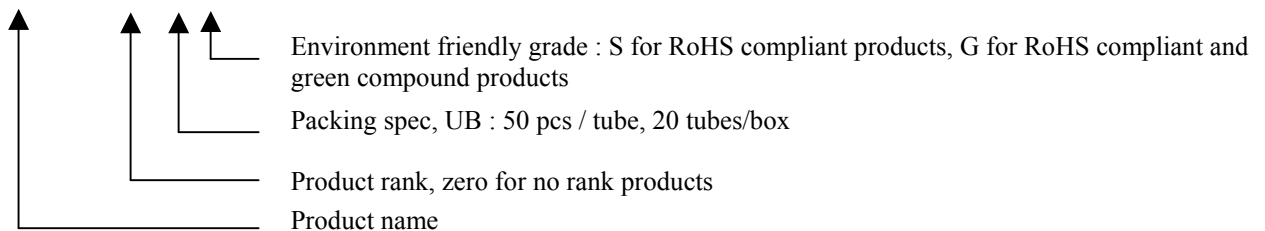

**Absolute Maximum Ratings** ($T_C=25^\circ\text{C}$, unless otherwise noted)

Parameter	Symbol	Limits	Unit	
Drain-Source Voltage	V_{DS}	60	V	
Gate-Source Voltage	V_{GS}	± 30		
Continuous Drain Current @ $T_C=25^\circ\text{C}$, $V_{GS}=10\text{V}$	I_D	52	A	
Continuous Drain Current @ $T_C=100^\circ\text{C}$, $V_{GS}=10\text{V}$		36.8		
Pulsed Drain Current (Note 4)	I_{DM}	208		
Continuous Drain Current @ $T_A=25^\circ\text{C}$ (Note 2)	I_{DSM}	11		
Continuous Drain Current @ $T_A=70^\circ\text{C}$ (Note 2)		8.8		
Avalanche Current (Note 5)	I_{AS}	30		
Avalanche Energy @ $L=1\text{mH}$, $I_D=20\text{A}$, $R_G=25\ \Omega$ (Note 5)	E_{AS}	200	mJ	
Repetitive Avalanche Energy @ $L=0.1\text{mH}$ (Note 3)	E_{AR}	6		
Power Dissipation	P_D	$T_C=25^\circ\text{C}$ (Note 1)	62.5	W
		$T_C=100^\circ\text{C}$ (Note 1)	31.3	
Power Dissipation	P_{DSM}	$T_A=25^\circ\text{C}$ (Note 2)	2	
		$T_A=70^\circ\text{C}$ (Note 2)	1.3	
Operating Junction and Storage Temperature		T_J, T_{stg}	-55~+175	$^\circ\text{C}$

Thermal Data

Parameter	Symbol	Value	Unit
Thermal Resistance, Junction-to-case, max	$R_{th,j-c}$	2.4	$^\circ\text{C}/\text{W}$
Thermal Resistance, Junction-to-ambient, max, $t \leq 10\text{s}$ (Note 1)	$R_{th,j-a}$	15	
Thermal Resistance, Junction-to-ambient, max (Note 1)		62.5	

- Note : 1. The power dissipation P_D is based on $T_{J(MAX)}=175^\circ\text{C}$, using junction-to-case thermal resistance, and is more useful in setting the upper dissipation limit for cases where additional heatsinking is used.
2. The value of $R_{\theta JA}$ is measured with the device mounted on 1 in² FR-4 board with 2 oz. copper, in a still air environment with $T_A=25^\circ\text{C}$. The power dissipation P_{DSM} is based on $R_{\theta JA}$ and the maximum allowed junction temperature of 150°C . The value in any given application depends on the user's specific board design, and the maximum temperature of 175°C may be used if the PCB allows it.
3. Repetitive rating, pulse width limited by junction temperature $T_{J(MAX)}=175^\circ\text{C}$. Ratings are based on low frequency and low duty cycles to keep initial $T_J=25^\circ\text{C}$.
4. Pulse width $\leq 300\ \mu\text{s}$ and duty cycle $\leq 0.5\%$.
5. Pulse width limited by junction temperature.
6. The $R_{\theta JA}$ is the sum of thermal resistance from junction to case $R_{\theta JC}$ and case to ambient.



Characteristics (Tc=25°C, unless otherwise specified)

Symbol	Min.	Typ.	Max.	Unit	Test Conditions
Static					
BV _{DSS}	60	-	-	V	V _{GS} =0V, I _D =250μA
V _{GS(th)}	2.0	-	4.0		V _{DS} = V _{GS} , I _D =250μA
G _{FS}	-	30	-	S	V _{DS} =5V, I _D =20A
I _{GSS}	-	-	±100	nA	V _{GS} =±30V
I _{DSS}	-	-	1	μA	V _{DS} =60V, V _{GS} =0V
	-	-	10		V _{DS} =48V, V _{GS} =0V, T _j =55°C
*R _{DS(ON)}	-	7.4	10.6	mΩ	V _{GS} =10V, I _D =30A
	-	8.1	13.5		V _{GS} =7V, I _D =20A
Dynamic					
*Q _g	-	34.8	-	nC	I _D =30A, V _{DS} =48V, V _{GS} =10V
*Q _{gs}	-	6.3	-		
*Q _{gd}	-	16.7	-		
*t _{d(ON)}	-	16	-	ns	V _{DS} =30V, I _D =30A, V _{GS} =10V, R _G =2.7Ω
*t _r	-	21.6	-		
*t _{d(OFF)}	-	38.2	-		
*t _f	-	14.2	-		
C _{iss}	-	1429	-	pF	V _{GS} =0V, V _{DS} =30V, f=1MHz
C _{oss}	-	265	-		
C _{rss}	-	129	-		
Source-Drain Diode					
*I _S	-	-	52	A	
*V _{SD}	-	0.86	1.2	V	I _S =30A, V _{GS} =0V
*t _{rr}	-	18.3	-	ns	I _F =30A, V _{GS} =0, dI _F /dt=100A/μs
*Q _{rr}	-	13.6	-	nC	

*Pulse Test : Pulse Width ≤300μs, Duty Cycle≤2%



Typical Characteristics

Typical Output Characteristics

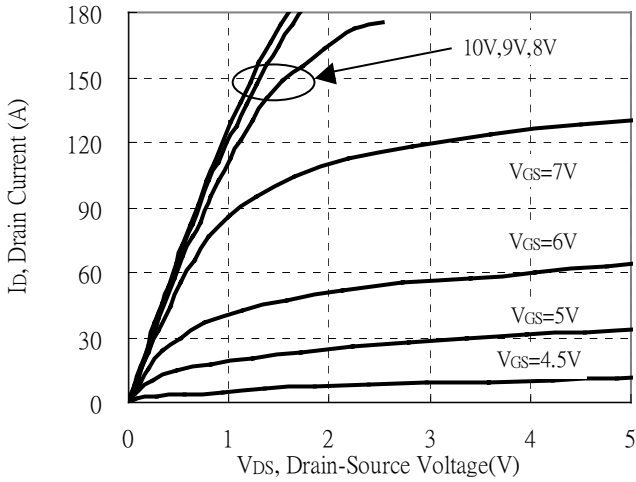

Brekdown Voltage vs Ambient Temperature

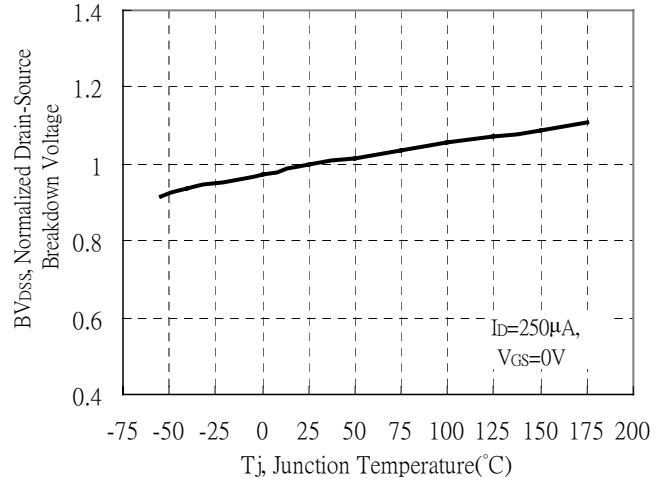

Static Drain-Source On-State resistance vs Drain Current

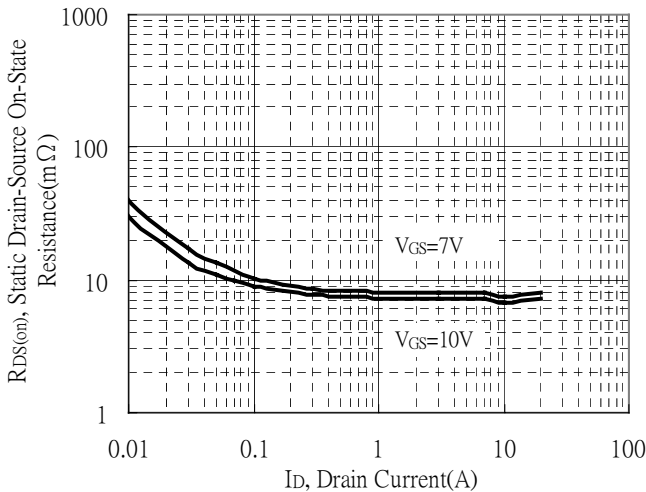

Reverse Drain Current vs Source-Drain Voltage

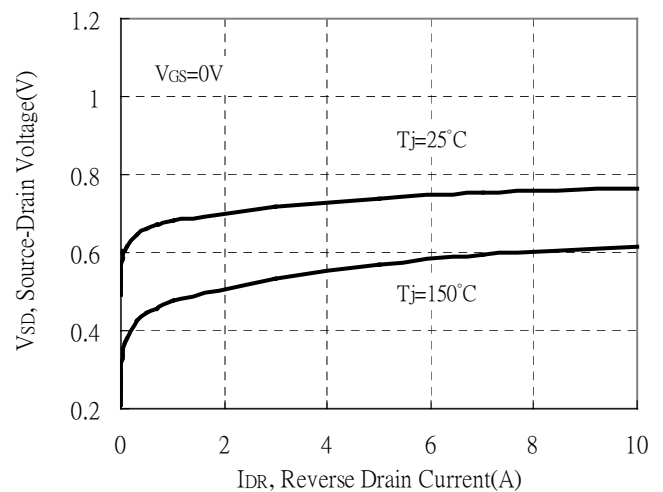

Static Drain-Source On-State Resistance vs Gate-Source Voltage

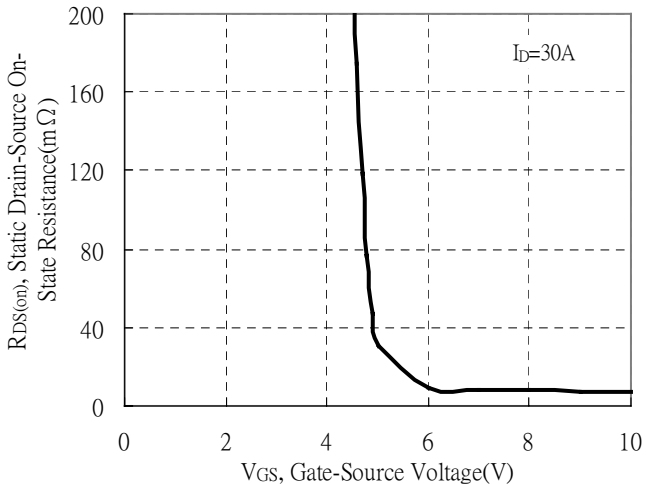

Drain-Source On-State Resistance vs Junction Temperature

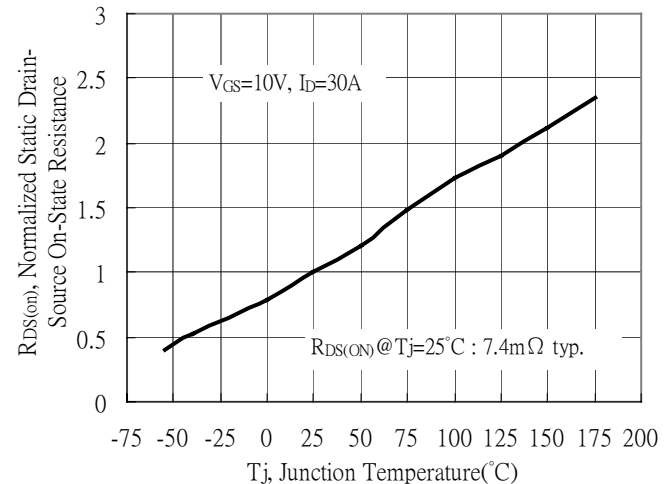



Typical Characteristics(Cont.)

Capacitance vs Drain-to-Source Voltage

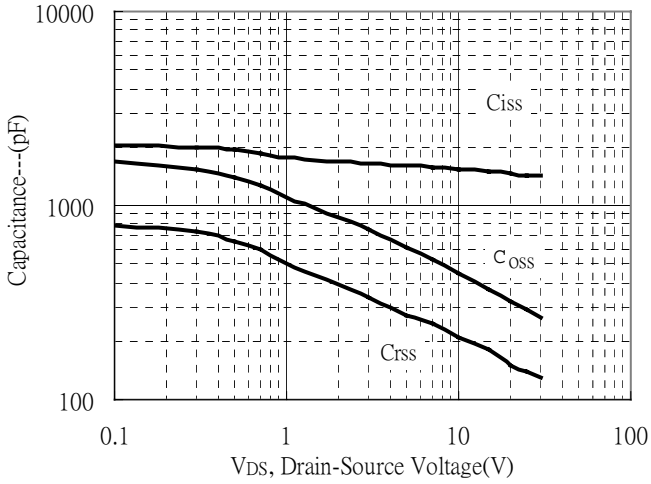

Threshold Voltage vs Junction Temperature

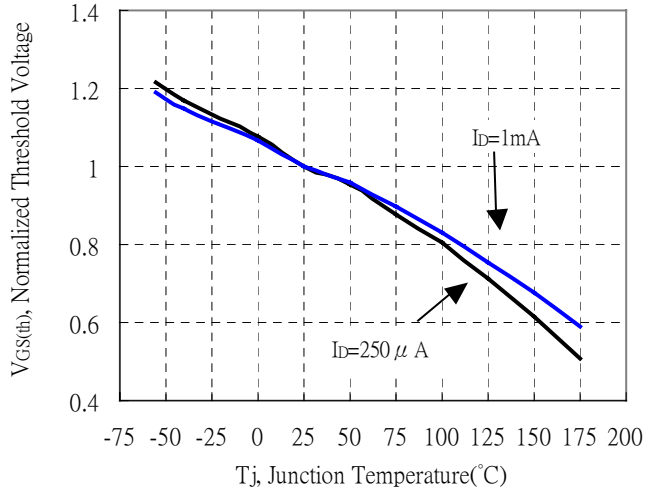

Forward Transfer Admittance vs Drain Current

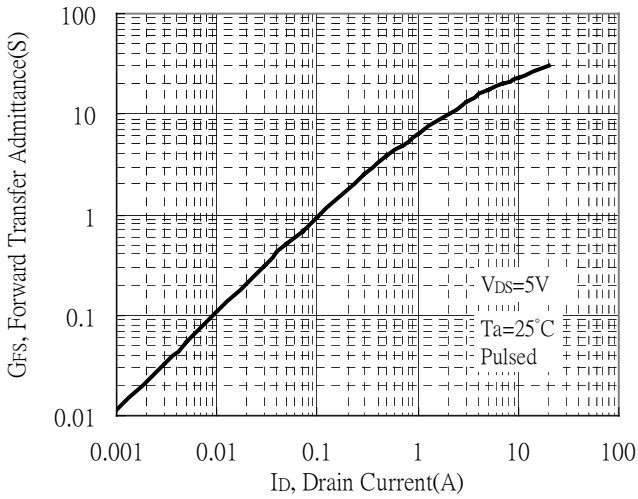

Gate Charge Characteristics

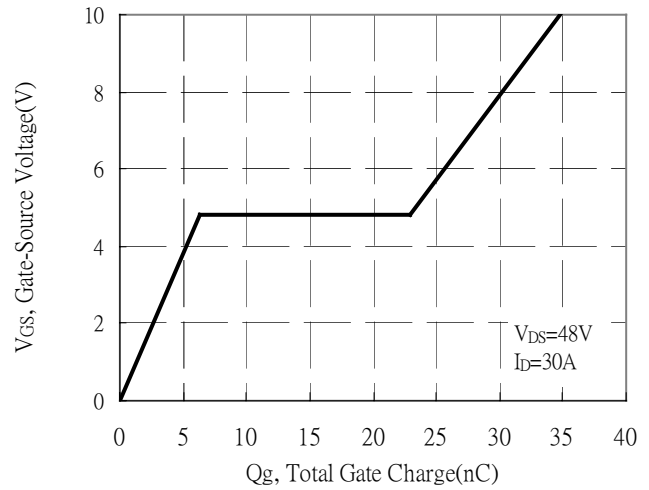

Maximum Safe Operating Area

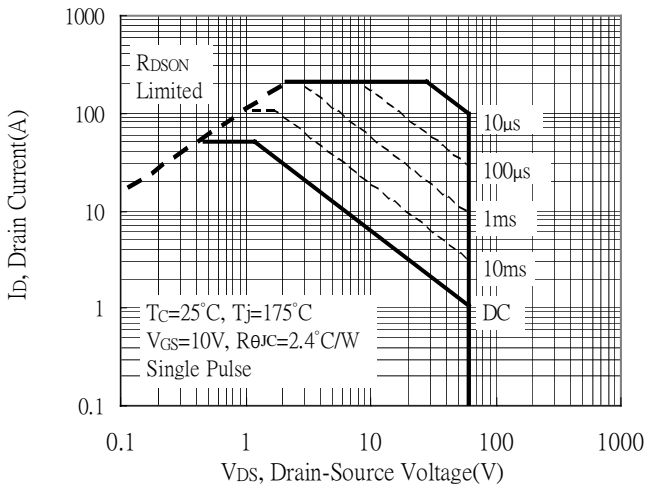

Maximum Drain Current vs Case Temperature

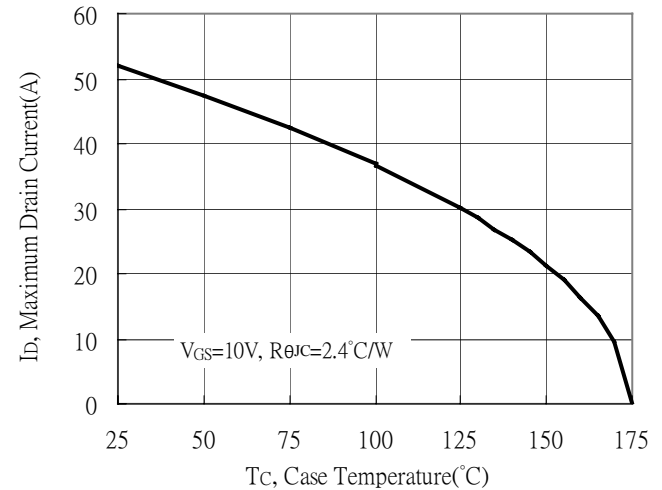

Typical Characteristics(Cont.)

Typical Transfer Characteristics

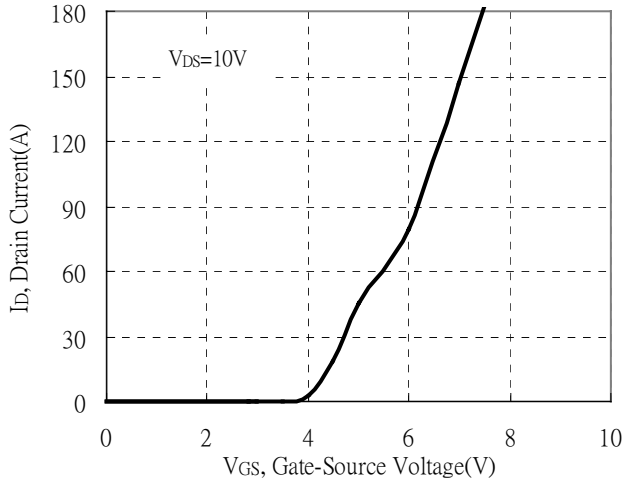

Single Pulse Power Rating, Junction to Case

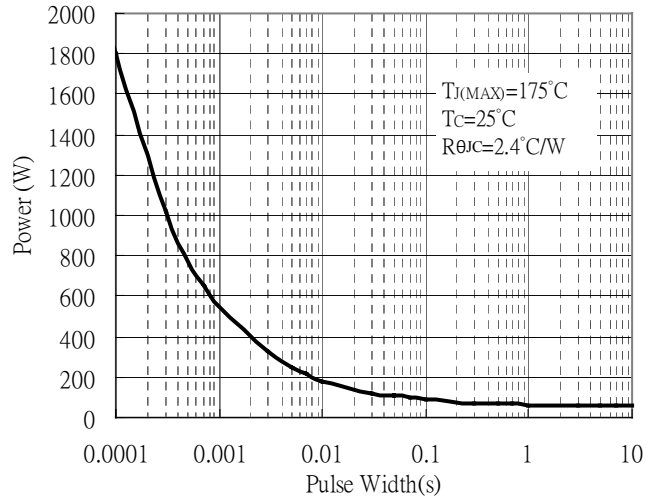

Transient Thermal Response Curves

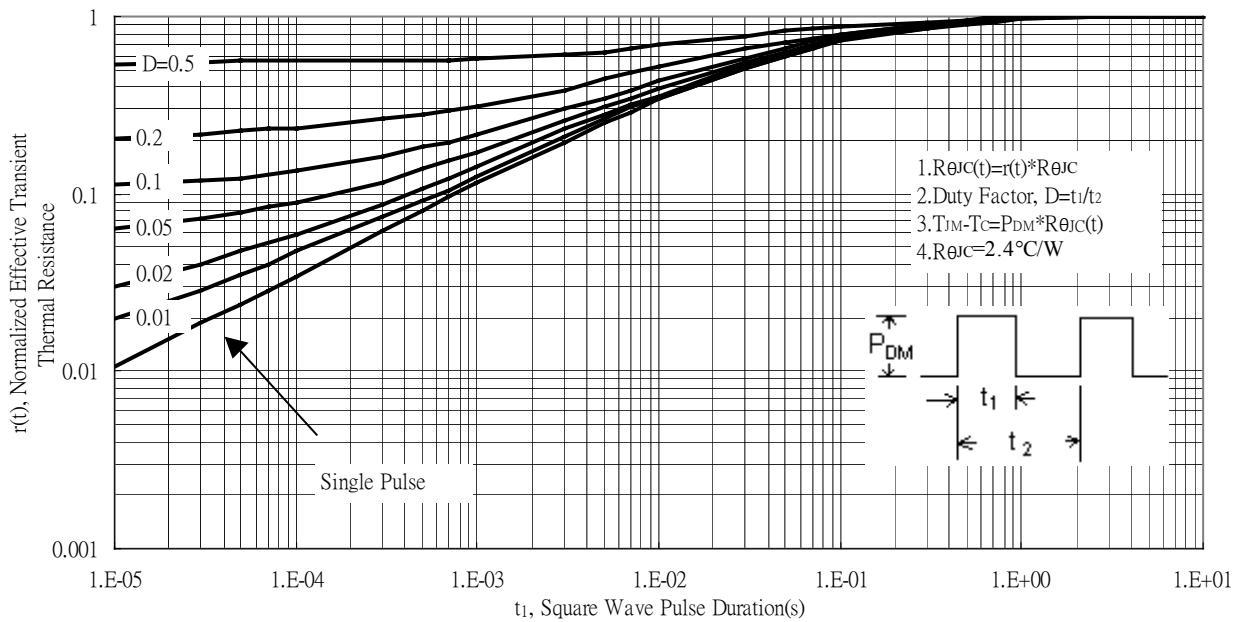

Recommended wave soldering condition

Product	Peak Temperature	Soldering Time
Pb-free devices	260 +0/-5 °C	5 +1/-1 seconds

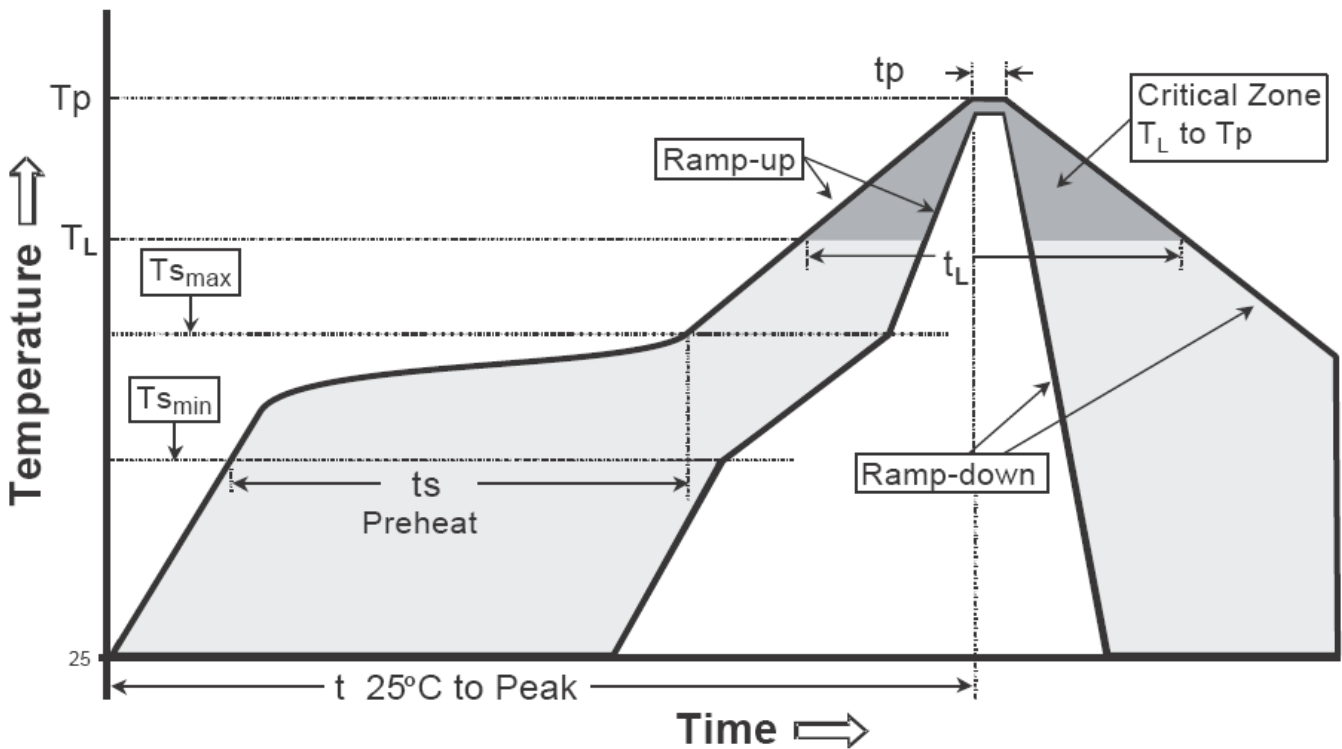
Recommended temperature profile for IR reflow

Profile feature	Sn-Pb eutectic Assembly	Pb-free Assembly
Average ramp-up rate (T _{smax} to T _p)	3°C/second max.	3°C/second max.
Preheat		
-Temperature Min(T _{s min})	100°C	150°C
-Temperature Max(T _{s max})	150°C	200°C
-Time(t _{s min} to t _{s max})	60-120 seconds	60-180 seconds
Time maintained above:		
-Temperature (T _L)	183°C	217°C
- Time (t _L)	60-150 seconds	60-150 seconds
Peak Temperature(T _P)	240 +0/-5 °C	260 +0/-5 °C
Time within 5°C of actual peak temperature(tp)	10-30 seconds	20-40 seconds
Ramp down rate	6°C/second max.	6°C/second max.
Time 25 °C to peak temperature	6 minutes max.	8 minutes max.

Note : All temperatures refer to topside of the package, measured on the package body surface.

TO-220FP Dimension

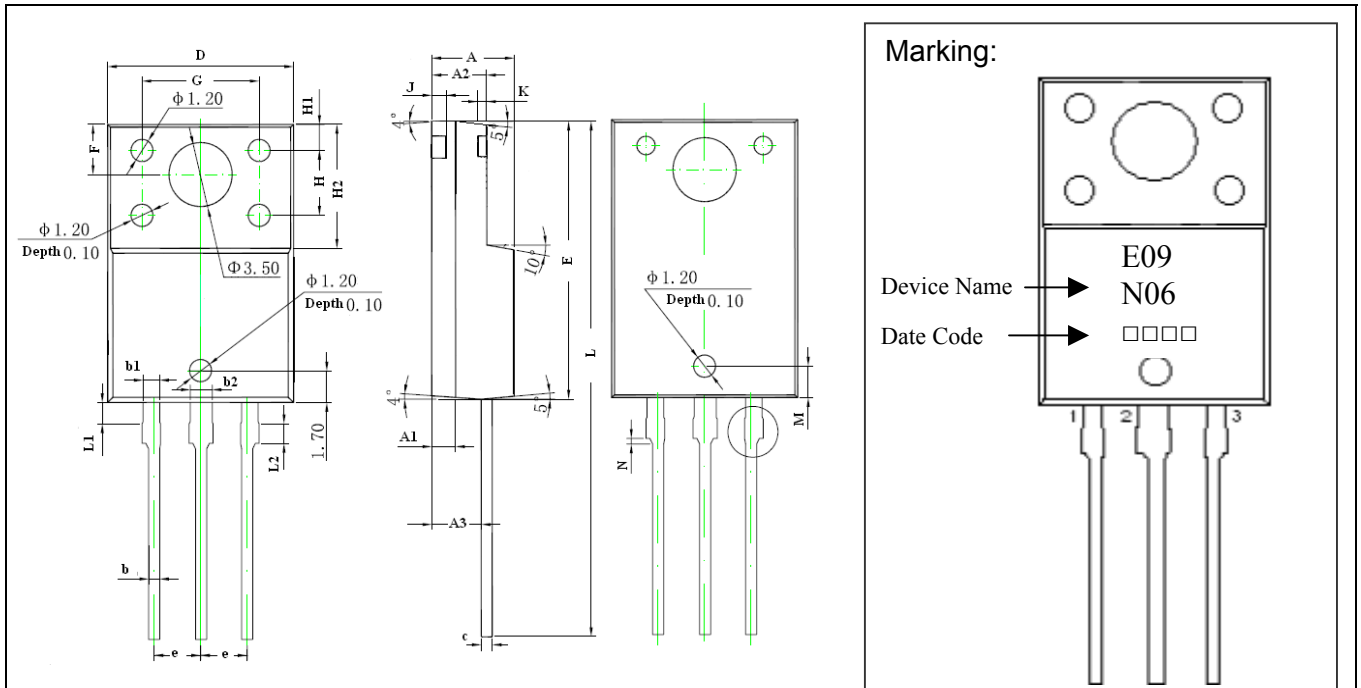

3-Lead TO-220FP Plastic Package
 CYStek Package Code: FP

Marking:

Device Name → E09
 N06
 Date Code → □□□□

Style: Pin 1.Gate 2.Drain 3.Source

*Typical

DIM	Inches		Millimeters		DIM	Inches		Millimeters	
	Min.	Max.	Min.	Max.		Min.	Max.	Min.	Max.
A	0.171	0.183	4.35	4.65	G	0.246	0.258	6.25	6.55
A1	0.051 REF		1.300 REF		H	0.138 REF		3.50 REF	
A2	0.112	0.124	2.85	3.15	H1	0.055 REF		1.40 REF	
A3	0.102	0.110	2.60	2.80	H2	0.256	0.272	6.50	6.90
b	0.020	0.030	0.50	0.75	J	0.031 REF		0.80 REF	
b1	0.031	0.041	0.80	1.05	K	0.020		0.50 REF	
b2	0.047 REF		1.20 REF		L	1.102	1.118	28.00	28.40
c	0.020	0.030	0.500	0.750	L1	0.043	0.051	1.10	1.30
D	0.396	0.404	10.06	10.26	L2	0.036	0.043	0.92	1.08
E	0.583	0.598	14.80	15.20	M	0.067 REF		1.70 REF	
e	0.100 *		2.54*		N	0.012 REF		0.30 REF	
F	0.106 REF		2.70 REF						

- Notes:**
- Controlling dimension: millimeters.
 - Maximum lead thickness includes lead finish thickness, and minimum lead thickness is the minimum thickness of base material.
 - If there is any question with packing specification or packing method, please contact your local CYStek sales office.

Material:

- Lead: Pure tin plated.
- Mold Compound: Epoxy resin family, flammability solid burning class: UL94V-0.

Important Notice:

- All rights are reserved. Reproduction in whole or in part is prohibited without the prior written approval of CYStek.
- CYStek reserves the right to make changes to its products without notice.
- CYStek **semiconductor products are not warranted to be suitable for use in Life-Support Applications, or systems.**
- CYStek assumes no liability for any consequence of customer product design, infringement of patents, or application assistance.