



# Improved Precision Micropower Shunt Voltage Reference with Multiple Reverse Breakdown Voltages

LM4040

## General Description

The LM4040 is a precision two-terminal shunt mode, bandgap voltage reference available in fixed reverse breakdown voltages of 2.048V, 2.500V, 3.000V, 3.3V, 4.096V, and 5.000V. Ideal for space-critical applications, the LM4040 is offered in the subminiature 3-pin SC70 surface-mount package (1.8mm × 1.8mm), 50% smaller than comparable devices in SOT23 surface-mount packages (SOT23 versions are also available).

Laser-trimmed resistors ensure precise initial accuracy. With a 100ppm/°C temperature coefficient, the device is offered in four grades of initial accuracy ranging from 0.1% to 1%. The LM4040 has a 60µA to 15mA shunt current capability with low dynamic impedance, ensuring stable reverse breakdown voltage accuracy over a wide range of operating temperatures and currents.

The LM4040 does not require an external stabilizing capacitor while ensuring stability with any capacitive load.

The LM4040 is guaranteed over the temperature range of -40°C to +125°C.

For a 1.225V output version, refer to the LM4041 data sheet.

## Applications

Portable, Battery-Powered Equipment  
 Notebook Computers  
 Cell Phones  
 Industrial Process Controls

## Pin Configuration

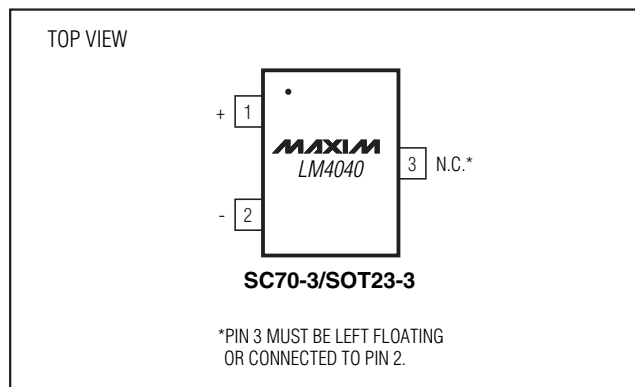

## Features

- ◆ Ultra-Small 3-Pin SC70 Package
- ◆ 0.1% (max) Initial Accuracy
- ◆ 100ppm/°C (max) Temperature Coefficient  
Guaranteed over -40°C to +125°C Temperature Range
- ◆ Wide Operating Current Range: 60µA to 15mA
- ◆ Low 28µVRMS Output Noise (10Hz to 10kHz)
- ◆ 2.048V, 2.500V, 3.000V, 3.3V, 4.096V, and 5.000V Fixed Reverse Breakdown Voltages
- ◆ No Output Capacitors Required
- ◆ Tolerates Capacitive Loads

## Selector Guide

PART	TEMP RANGE	PIN-PACKAGE	OUTPUT VOLTAGE (V)
LM4040_IM3-2.1	-40°C to +85°C	3 SOT23-3	2.048
LM4040_IX3-2.1	-40°C to +85°C	3 SC70-3	2.048
LM4040_EM3-2.1	-40°C to +125°C	3 SOT23-3	2.048
LM4040_EX3-2.1	-40°C to +125°C	3 SC70-3	2.048
LM4040_IM3-2.5	-40°C to +85°C	3 SOT23-3	2.500
LM4040_IX3-2.5	-40°C to +85°C	3 SC70-3	2.500
LM4040_EM3-2.5	-40°C to +125°C	3 SOT23-3	2.500
LM4040_EX3-2.5	-40°C to +125°C	3 SC70-3	2.500
LM4040_IM3-3.0	-40°C to +85°C	3 SOT23-3	3.000
LM4040_IX3-3.0	-40°C to +85°C	3 SC70-3	3.000
LM4040_EM3-3.0	-40°C to +125°C	3 SOT23-3	3.000
LM4040_EX3-3.0	-40°C to +125°C	3 SC70-3	3.000
LM4040_EX3-3.3	-40°C to +125°C	3 SC70-3	3.300
LM4040_IM3-4.1	-40°C to +85°C	3 SOT23-3	4.096
LM4040_IX3-4.1	-40°C to +85°C	3 SC70-3	4.096
LM4040_EM3-4.1	-40°C to +125°C	3 SOT23-3	4.096
LM4040_EX3-4.1	-40°C to +125°C	3 SC70-3	4.096
LM4040_IM3-5.0	-40°C to +85°C	3 SOT23-3	5.000
LM4040_IX3-5.0	-40°C to +85°C	3 SC70-3	5.000
LM4040_EM3-5.0	-40°C to +125°C	3 SOT23-3	5.000
LM4040_EX3-5.0	-40°C to +125°C	3 SC70-3	5.000

Ordering Information appears at end of data sheet.



# Improved Precision Micropower Shunt Voltage Reference with Multiple Reverse Breakdown Voltages

## ABSOLUTE MAXIMUM RATINGS

Reverse Current (cathode to anode) .....20mA  
 Forward Current (anode to cathode) .....10mA  
 Continuous Power Dissipation (T<sub>A</sub> = +70°C)  
   3-Pin SC70 (derate 2.17mW/°C above +70°C).....174mW  
   3-Pin SOT23 (derate 4.01mW/°C above +70°C).....320mW

Operating Temperature Range  
   LM4040\_L\_ \_ \_ .....-40°C to +85°C  
   LM4040\_E\_ \_ \_ .....-40°C to +125°C  
 Storage Temperature Range .....-65°C to +150°C  
 Junction Temperature .....+150°C  
 Lead Temperature (soldering, 10s).....+300°C

Stresses beyond those listed under "Absolute Maximum Ratings" may cause permanent damage to the device. These are stress ratings only, and functional operation of the device at these or any other conditions beyond those indicated in the operational sections of the specifications is not implied. Exposure to absolute maximum rating conditions for extended periods may affect device reliability.

## ELECTRICAL CHARACTERISTICS—2.048V

(I<sub>R</sub> = 100µA, T<sub>A</sub> = T<sub>MIN</sub> to T<sub>MAX</sub>, unless otherwise noted. Typical values are at T<sub>A</sub> = +25°C.) (Note 1)

PARAMETER	SYMBOL	CONDITIONS		MIN	TYP	MAX	UNITS
Reverse Breakdown Voltage	V <sub>R</sub>	T <sub>A</sub> = +25°C	LM4040A (0.1%)	2.046	2.048	2.050	V
			LM4040B (0.2%)	2.044	2.048	2.052	
			LM4040C (0.5%)	2.038	2.048	2.058	
			LM4040D (1.0%)	2.028	2.048	2.068	
Reverse Breakdown Voltage Tolerance (Note 2)	V <sub>R</sub>	LM4040A		±2.0	±15	mV	
		LM4040B		±4.0	±17		
		LM4040C		±10	±23		
		LM4040D		±20	±41		
Minimum Operating Current	I <sub>RMIN</sub>	LM4040A/B/C		45	65	µA	
		LM4040D		45	70		
Average Reverse Voltage Temperature Coefficient (Note 2)	ΔV <sub>R</sub> /ΔT	I <sub>R</sub> = 10mA		±20		ppm/°C	
		I <sub>R</sub> = 1mA	LM4040A/B/C		±15		±100
			LM4040D		±15		±150
Reverse Breakdown Voltage Change with Operating Current Change		I <sub>RMIN</sub> ≤ I <sub>R</sub> ≤ 1mA	LM4040A/B/C		0.3	1.0	mV
			LM4040D		0.3	1.2	
		1mA ≤ I <sub>R</sub> ≤ 15mA	LM4040A/B/C		2.5	8.0	
			LM4040D		2.5	10.0	
Reverse Dynamic Impedance (Note 3)	Z <sub>R</sub>	I <sub>R</sub> = 1mA, f = 120Hz, I <sub>AC</sub> = 0.1I <sub>R</sub>	LM4040A/B		0.3	0.8	Ω
			LM4040C		0.3	0.9	
			LM4040D		0.3	1.1	
Wideband Noise	e <sub>N</sub>	I <sub>R</sub> = 100µA, 10Hz ≤ f ≤ 10kHz		28		µV <sub>RMS</sub>	
Reverse Breakdown Voltage Long-Term Stability	ΔV <sub>R</sub>	T = 1000h		120		ppm	

# Improved Precision Micropower Shunt Voltage Reference with Multiple Reverse Breakdown Voltages

**LM4040**

## ELECTRICAL CHARACTERISTICS—2.500V

( $I_R = 100\mu\text{A}$ ,  $T_A = T_{\text{MIN}}$  to  $T_{\text{MAX}}$ , unless otherwise noted. Typical values are at  $T_A = +25^\circ\text{C}$ .) (Note 1)

PARAMETER	SYMBOL	CONDITIONS		MIN	TYP	MAX	UNITS
Reverse Breakdown Voltage	$V_R$	$T_A = +25^\circ\text{C}$	LM4040A (0.1%)	2.4975	2.5000	2.5025	V
			LM4040B (0.2%)	2.4950	2.5000	2.5050	
			LM4040C (0.5%)	2.4875	2.5000	2.5125	
			LM4040D (1.0%)	2.4750	2.5000	2.5250	
Reverse Breakdown Voltage Tolerance (Note 2)	$V_R$	LM4040A		$\pm 2.0$	$\pm 19$	mV	
		LM4040B		$\pm 4.0$	$\pm 21$		
		LM4040C		$\pm 10$	$\pm 29$		
		LM4040D		$\pm 20$	$\pm 49$		
Minimum Operating Current	$I_{R\text{MIN}}$	LM4040A/B/C		45	65	$\mu\text{A}$	
		LM4040D		45	70		
Average Reverse Voltage Temperature Coefficient (Note 2)	$\Delta V_R/\Delta T$	$I_R = 10\text{mA}$		$\pm 20$		ppm/ $^\circ\text{C}$	
		$I_R = 1\text{mA}$	LM4040A/B/C	$\pm 15$	$\pm 100$		
			LM4040D	$\pm 15$	$\pm 150$		
		$I_R = 100\mu\text{A}$		$\pm 15$			
Reverse Breakdown Voltage Change with Operating Current Change		$I_{R\text{MIN}} \leq I_R \leq 1\text{mA}$	LM4040A/B/C		0.3	1.0	mV
			LM4040D		0.4	1.2	
		$1\text{mA} \leq I_R \leq 15\text{mA}$	LM4040A/B/C		2.5	8.0	
			LM4040D		2.5	10.0	
Reverse Dynamic Impedance (Note 3)	$Z_R$	$I_R = 1\text{mA}$ , $f = 120\text{Hz}$ , $I_{AC} = 0.1I_R$	LM4040A/B		0.3	0.8	$\Omega$
			LM4040C		0.3	0.9	
			LM4040D		0.3	1.1	
Wideband Noise	$e_N$	$I_R = 100\mu\text{A}$ , $10\text{Hz} \leq f \leq 10\text{kHz}$		35		$\mu\text{VRMS}$	
Reverse Breakdown Voltage Long-Term Stability	$\Delta V_R$	$T = 1000\text{h}$		120		ppm	

# Improved Precision Micropower Shunt Voltage Reference with Multiple Reverse Breakdown Voltages

## ELECTRICAL CHARACTERISTICS—3.000V

( $I_R = 100\mu\text{A}$ ,  $T_A = T_{\text{MIN}}$  to  $T_{\text{MAX}}$ , unless otherwise noted. Typical values are at  $T_A = +25^\circ\text{C}$ .) (Note 1)

PARAMETER	SYMBOL	CONDITIONS		MIN	TYP	MAX	UNITS
Reverse Breakdown Voltage	$V_R$	$T_A = +25^\circ\text{C}$	LM4040A (0.1%)	2.997	3.000	3.003	V
			LM4040B (0.2%)	2.994	3.000	3.006	
			LM4040C (0.5%)	2.985	3.000	3.015	
			LM4040D (1.0%)	2.970	3.000	3.030	
Reverse Breakdown Voltage Tolerance (Note 2)	$V_R$	LM4040A		$\pm 3.0$	$\pm 22$	mV	
		LM4040B		$\pm 6.0$	$\pm 26$		
		LM4040C		$\pm 15$	$\pm 34$		
		LM4040D		$\pm 30$	$\pm 59$		
Minimum Operating Current	$I_{R\text{MIN}}$	LM4040A/B/C		45	67	$\mu\text{A}$	
		LM4040D		45	70		
Average Reverse Voltage Temperature Coefficient (Note 2)	$\Delta V_R/\Delta T$	$I_R = 10\text{mA}$		$\pm 20$		ppm/ $^\circ\text{C}$	
		$I_R = 1\text{mA}$	LM4040A/B/C	$\pm 15$	$\pm 100$		
			LM4040D	$\pm 15$	$\pm 150$		
$I_R = 100\mu\text{A}$		$\pm 15$					
Reverse Breakdown Voltage Change with Operating Current Change		$I_{R\text{MIN}} \leq I_R \leq 1\text{mA}$	LM4040A/B/C		0.3	1.0	mV
			LM4040D		0.3	1.2	
		$1\text{mA} \leq I_R \leq 15\text{mA}$	LM4040A/B/C		2.5	8.0	
			LM4040D		2.5	10.0	
Reverse Dynamic Impedance (Note 3)	$Z_R$	$I_R = 1\text{mA}$ , $f = 120\text{Hz}$ , $I_{AC} = 0.1I_R$	LM4040A/B		0.3	0.8	$\Omega$
			LM4040C		0.3	0.9	
			LM4040D		0.3	1.1	
Wideband Noise	$e_N$	$I_R = 100\mu\text{A}$ , $10\text{Hz} \leq f \leq 10\text{kHz}$		45		$\mu\text{VRMS}$	
Reverse Breakdown Voltage Long-Term Stability	$\Delta V_R$	$T = 1000\text{h}$		120		ppm	

# Improved Precision Micropower Shunt Voltage Reference with Multiple Reverse Breakdown Voltages

**LM4040**

## ELECTRICAL CHARACTERISTICS—3.300V

( $I_R = 100\mu\text{A}$ ,  $T_A = T_{\text{MIN}}$  to  $T_{\text{MAX}}$ , unless otherwise noted. Typical values are at  $T_A = +25^\circ\text{C}$ .) (Note 1)

PARAMETER	SYMBOL	CONDITIONS		MIN	TYP	MAX	UNITS
Reverse Breakdown Voltage	$V_R$	$T_A = +25^\circ\text{C}$	LM4040A (0.1%)	3.2967	3.3000	3.3033	V
			LM4040B (0.2%)	3.2934	3.3000	3.3066	
			LM4040C (0.5%)	3.2835	3.3000	3.3165	
			LM4040D (1.0%)	3.2670	3.3000	3.3330	
Reverse Breakdown Voltage Tolerance (Note 2)	$V_R$	LM4040A		$\pm 3.0$	$\pm 22$	mV	
		LM4040B		$\pm 6.0$	$\pm 26$		
		LM4040C		$\pm 15$	$\pm 34$		
		LM4040D		$\pm 30$	$\pm 59$		
Minimum Operating Current	$I_{R\text{MIN}}$	LM4040A/B/C		45	67	$\mu\text{A}$	
		LM4040D		45	70		
Average Reverse Voltage Temperature Coefficient (Note 2)	$\Delta V_R/\Delta T$	$I_R = 10\text{mA}$		$\pm 20$		ppm/ $^\circ\text{C}$	
		$I_R = 1\text{mA}$	LM4040A/B/C	$\pm 15$	$\pm 100$		
			LM4040D	$\pm 15$	$\pm 150$		
$I_R = 100\mu\text{A}$		$\pm 15$					
Reverse Breakdown Voltage Change with Operating Current Change		$I_{R\text{MIN}} \leq I_R \leq 1\text{mA}$	LM4040A/B/C		0.3	1.0	mV
			LM4040D		0.3	1.2	
		$1\text{mA} \leq I_R \leq 15\text{mA}$	LM4040A/B/C		2.5	8.0	
			LM4040D		2.5	10.0	
Reverse Dynamic Impedance (Note 3)	$Z_R$	$I_R = 1\text{mA}$ , $f = 120\text{Hz}$ , $I_{AC} = 0.1I_R$	LM4040A/B		0.3	0.8	$\Omega$
			LM4040C		0.3	0.9	
			LM4040D		0.3	1.1	
Wideband Noise	$e_N$	$I_R = 100\mu\text{A}$ , $10\text{Hz} \leq f \leq 10\text{kHz}$		50		$\mu\text{VRMS}$	
Reverse Breakdown Voltage Long-Term Stability	$\Delta V_R$	$T = 1000\text{h}$		120		ppm	

# Improved Precision Micropower Shunt Voltage Reference with Multiple Reverse Breakdown Voltages

## ELECTRICAL CHARACTERISTICS—4.096V

( $I_R = 100\mu\text{A}$ ,  $T_A = T_{\text{MIN}}$  to  $T_{\text{MAX}}$ , unless otherwise noted. Typical values are at  $T_A = +25^\circ\text{C}$ .) (Note 1)

PARAMETER	SYMBOL	CONDITIONS		MIN	TYP	MAX	UNITS
Reverse Breakdown Voltage	$V_R$	$T_A = +25^\circ\text{C}$	LM4040A (0.1%)	4.092	4.096	4.100	V
			LM4040B (0.2%)	4.088	4.096	4.104	
			LM4040C (0.5%)	4.076	4.096	4.116	
			LM4040D (1.0%)	4.055	4.096	4.137	
Reverse Breakdown Voltage Tolerance (Note 2)	$V_R$	LM4040A		$\pm 4.1$	$\pm 31$	mV	
		LM4040B		$\pm 8.2$	$\pm 35$		
		LM4040C		$\pm 20$	$\pm 47$		
		LM4040D		$\pm 41$	$\pm 81$		
Minimum Operating Current	$I_{R\text{MIN}}$	LM4040A/B/C		50	73	$\mu\text{A}$	
		LM4040D		50	78		
Average Reverse Voltage Temperature Coefficient (Note 2)	$\Delta V_R/\Delta T$	$I_R = 10\text{mA}$		$\pm 30$		ppm/ $^\circ\text{C}$	
		$I_R = 1\text{mA}$	LM4040A/B/C	$\pm 20$	$\pm 100$		
			LM4040D	$\pm 20$	$\pm 150$		
$I_R = 100\mu\text{A}$		$\pm 15$					
Reverse Breakdown Voltage Change with Operating Current Change		$I_{R\text{MIN}} \leq I_R \leq 1\text{mA}$	LM4040A/B/C	0.5	1.2	mV	
			LM4040D	0.5	1.5		
		$1\text{mA} \leq I_R \leq 15\text{mA}$	LM4040A/B/C	3.0	10.0		
			LM4040D	3.0	13.0		
Reverse Dynamic Impedance (Note 3)	$Z_R$	$I_R = 1\text{mA}$ , $f = 120\text{Hz}$ , $I_{AC} = 0.1I_R$	LM4040A/B/C	0.5	1.0	$\Omega$	
			LM4040D	0.5	1.3		
Wideband Noise	$e_N$	$I_R = 100\mu\text{A}$ , $10\text{Hz} \leq f \leq 10\text{kHz}$		64		$\mu\text{VRMS}$	
Reverse Breakdown Voltage Long-Term Stability	$\Delta V_R$	$T = 1000\text{h}$		120		ppm	

# Improved Precision Micropower Shunt Voltage Reference with Multiple Reverse Breakdown Voltages

**LM4040**

## ELECTRICAL CHARACTERISTICS—5.000V

( $I_R = 100\mu\text{A}$ ,  $T_A = T_{\text{MIN}}$  to  $T_{\text{MAX}}$ , unless otherwise noted. Typical values are at  $T_A = +25^\circ\text{C}$ .) (Note 1)

PARAMETER	SYMBOL	CONDITIONS		MIN	TYP	MAX	UNITS
Reverse Breakdown Voltage	$V_R$	$T_A = +25^\circ\text{C}$	LM4040A (0.1%)	4.995	5.000	5.005	V
			LM4040B (0.2%)	4.990	5.000	5.010	
			LM4040C (0.5%)	4.975	5.000	5.025	
			LM4040D (1.0%)	4.950	5.000	5.050	
Reverse Breakdown Voltage Tolerance (Note 2)	$V_R$	LM4040A		$\pm 5.0$	$\pm 38$	mV	
		LM4040B		$\pm 10$	$\pm 43$		
		LM4040C		$\pm 25$	$\pm 58$		
		LM4040D		$\pm 50$	$\pm 99$		
Minimum Operating Current	$I_{R\text{MIN}}$	LM4040A/B/C		54	80	$\mu\text{A}$	
		LM4040D		54	85		
Average Reverse Voltage Temperature Coefficient (Note 2)	$\Delta V_R/\Delta T$	$I_R = 10\text{mA}$		$\pm 30$		ppm/ $^\circ\text{C}$	
		$I_R = 1\text{mA}$	LM4040A/B/C	$\pm 20$	$\pm 100$		
			LM4040D	$\pm 20$	$\pm 150$		
		$I_R = 100\mu\text{A}$		$\pm 15$			
Reverse Breakdown Voltage Change with Operating Current Change		$I_{R\text{MIN}} \leq I_R \leq 1\text{mA}$	LM4040A/B/C	0.5	1.4	mV	
			LM4040D	0.5	1.8		
		$1\text{mA} \leq I_R \leq 15\text{mA}$	LM4040A/B/C	3.5	12.0		
			LM4040D	3.5	15.0		
Reverse Dynamic Impedance (Note 3)	$Z_R$	$I_R = 1\text{mA}$ , $f = 120\text{Hz}$ , $I_{AC} = 0.1I_R$	LM4040A/B/C	0.5	1.1	$\Omega$	
			LM4040D	0.5	1.5		
Wideband Noise	$e_N$	$I_R = 100\mu\text{A}$ , $10\text{Hz} \leq f \leq 10\text{kHz}$		80		$\mu\text{VRMS}$	
Reverse Breakdown Voltage Long-Term Stability	$\Delta V_R$	$T = 1000\text{h}$		120		ppm	

**Note 1:** All devices are 100% production tested at  $+25^\circ\text{C}$  and are guaranteed by design for  $T_A = T_{\text{MIN}}$  to  $T_{\text{MAX}}$ , as specified.

**Note 2:** The overtemperature limit for Reverse Breakdown Voltage Tolerance is defined as the room-temperature Reverse Breakdown Voltage Tolerance  $\pm[(\Delta V_R / \Delta T)(\text{max}\Delta T)(V_R)]$ , where  $\Delta V_R / \Delta T$  is the  $V_R$  temperature coefficient,  $\text{max}\Delta T$  is the maximum difference in temperature from the reference point of  $+25^\circ\text{C}$  to  $T_{\text{MIN}}$  or  $T_{\text{MAX}}$ , and  $V_R$  is the reverse breakdown voltage. The total overtemperature tolerance for the different grades in the temperature range where  $\text{max}\Delta T = +65^\circ\text{C}$  is shown below:

A grade:  $\pm 0.75\% = \pm 0.1\% \pm 100\text{ppm}/^\circ\text{C} \times 65^\circ\text{C}$

B grade:  $\pm 0.85\% = \pm 0.2\% \pm 100\text{ppm}/^\circ\text{C} \times 65^\circ\text{C}$

C grade:  $\pm 1.15\% = \pm 0.5\% \pm 100\text{ppm}/^\circ\text{C} \times 65^\circ\text{C}$

D grade:  $\pm 1.98\% = \pm 1.0\% \pm 150\text{ppm}/^\circ\text{C} \times 65^\circ\text{C}$

The total over-temperature tolerance for the different grades in the extended temperature range where  $\text{max}\Delta T = +100^\circ\text{C}$  is shown below:

A grade:  $\pm 1.1\% = \pm 0.1\% \pm 100\text{ppm}/^\circ\text{C} \times 100^\circ\text{C}$

B grade:  $\pm 1.2\% = \pm 0.2\% \pm 100\text{ppm}/^\circ\text{C} \times 100^\circ\text{C}$

C grade:  $\pm 1.5\% = \pm 0.5\% \pm 100\text{ppm}/^\circ\text{C} \times 100^\circ\text{C}$

D grade:  $\pm 2.5\% = \pm 1.0\% \pm 150\text{ppm}/^\circ\text{C} \times 100^\circ\text{C}$

Therefore, as an example, the A-grade LM4040-2.5 has an over-temperature reverse breakdown voltage tolerance of  $\pm 2.5\% \times 0.75\% = \pm 19\text{mV}$ .

**Note 3:** Guaranteed by design.

# Improved Precision Micropower Shunt Voltage Reference with Multiple Reverse Breakdown Voltages

## Typical Operating Characteristics

( $I_R = 100\mu A$ , SC70-3 package,  $T_A = +25^\circ C$ , unless otherwise noted.)

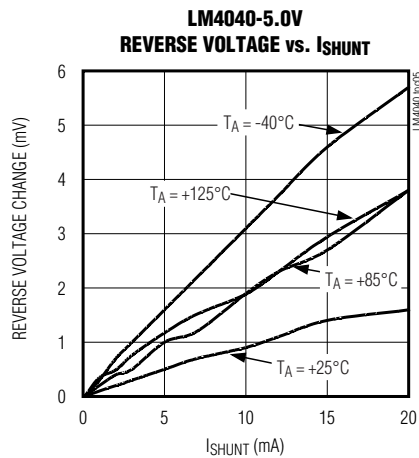
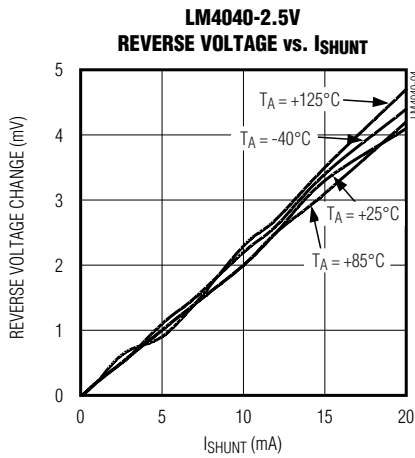
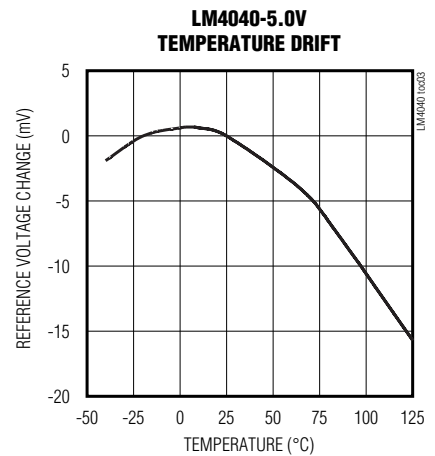
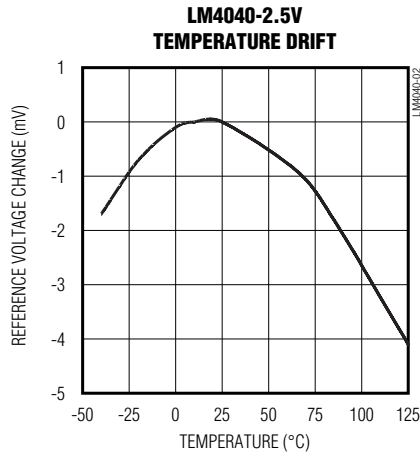
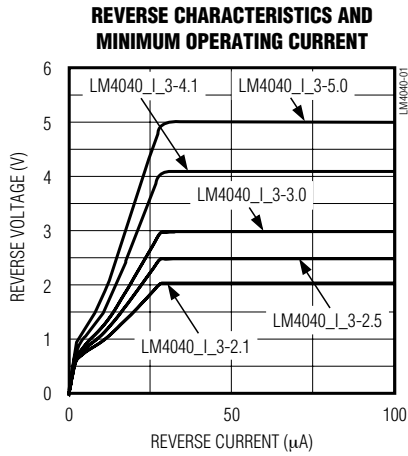



# Improved Precision Micropower Shunt Voltage Reference with Multiple Reverse Breakdown Voltages

## Typical Operating Characteristics (continued)

( $I_R = 100\mu\text{A}$ , SC70-3 package,  $T_A = +25^\circ\text{C}$ , unless otherwise noted.)

**LM4040**

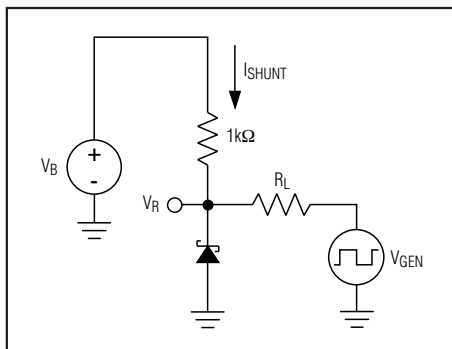
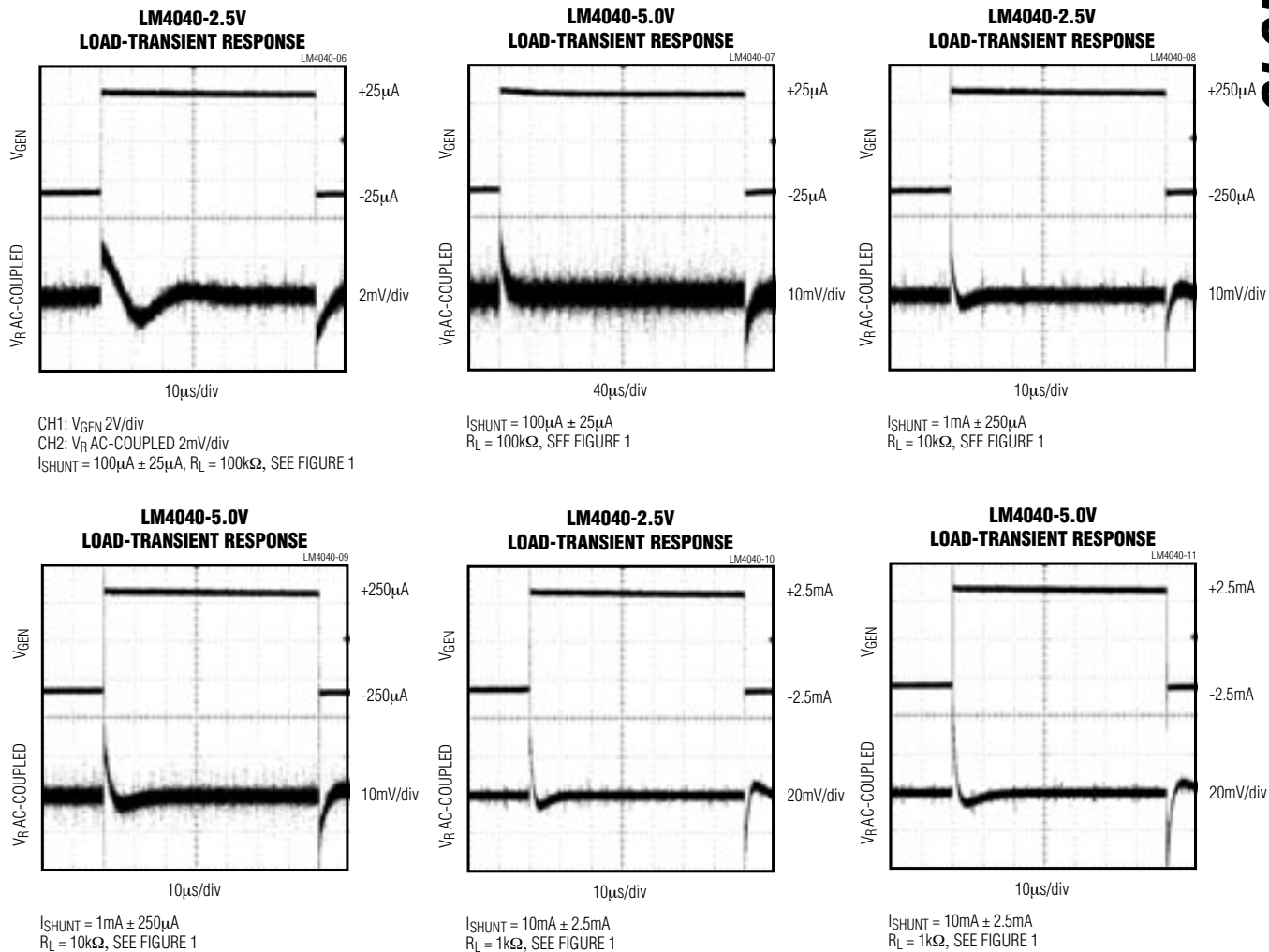

Figure 1. Load-Transient Test Circuit

# Improved Precision Micropower Shunt Voltage Reference with Multiple Reverse Breakdown Voltages

## Typical Operating Characteristics (continued)

( $I_R = 100\mu\text{A}$ , SC70-3 package,  $T_A = +25^\circ\text{C}$ , unless otherwise noted.)

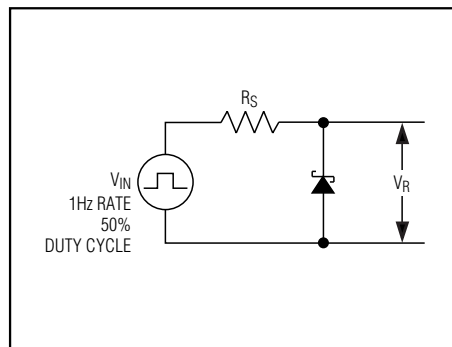
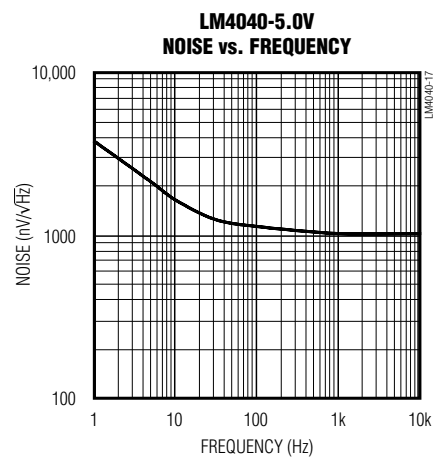
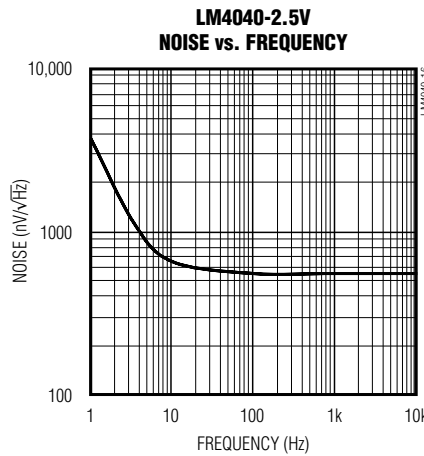
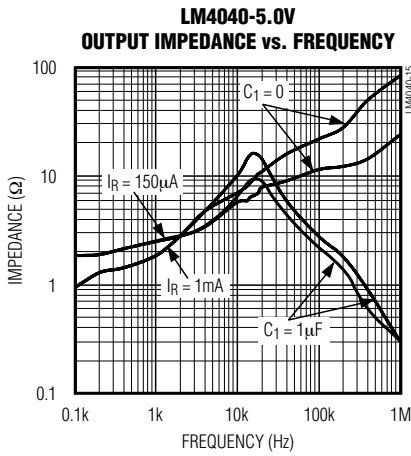
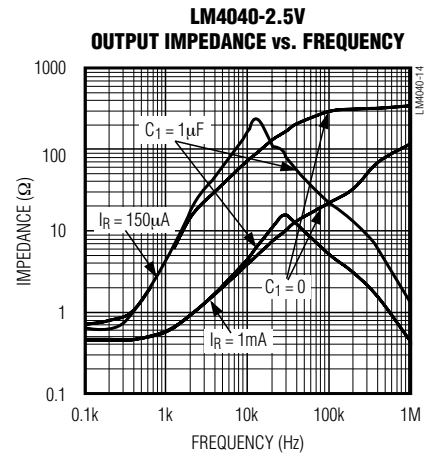
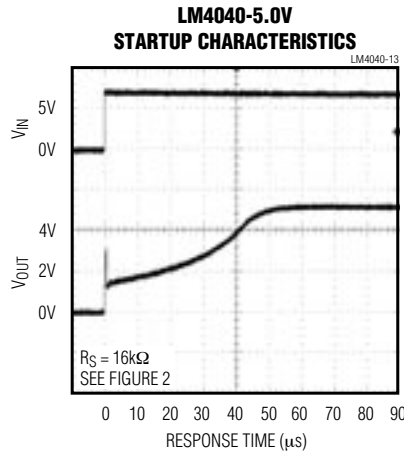
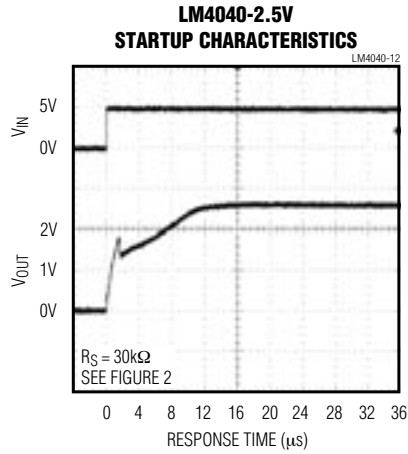

Figure 2. Startup Characteristics Test Circuit

# Improved Precision Micropower Shunt Voltage Reference with Multiple Reverse Breakdown Voltages

## Pin Description

PIN	NAME	FUNCTION
1	+	Positive Terminal of the Shunt Reference
2	-	Negative Terminal of the Shunt Reference
3	N.C.	No connection. Leave this pin unconnected or connected to Pin 2.

## Detailed Description

The LM4040 shunt references use the bandgap principle to produce a stable, accurate voltage. The device behaves similarly to an ideal zener diode; a fixed voltage is maintained across its output terminals when biased with 60µA to 15mA of reverse current. The LM4040 behaves similarly to a silicon diode when biased with forward currents up to 10mA.

Figure 3 shows a typical operating circuit. The LM4040 is ideal for providing a stable reference from a high-voltage power supply.

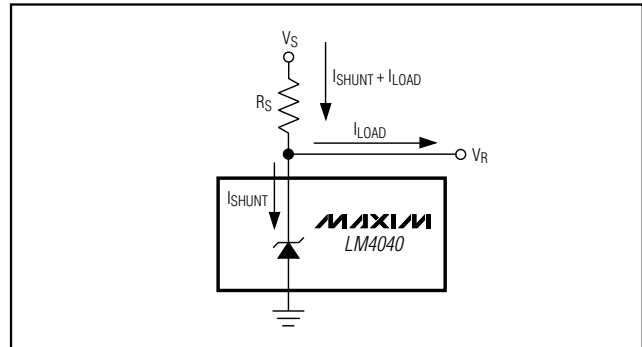

Figure 3. Typical Operating Circuit

## Applications Information

The LM4040's internal pass transistor is used to maintain a constant output voltage ( $V_{SHUNT}$ ) by sinking the necessary amount of current across a source resistor. The source resistance ( $R_S$ ) is determined from the load current ( $I_{LOAD}$ ) range, supply voltage ( $V_S$ ) variations,  $V_{SHUNT}$ , and desired quiescent current.

Choose the value of  $R_S$  when  $V_S$  is at a minimum and  $I_{LOAD}$  is at a maximum. Maintain a minimum  $I_{SHUNT}$  of 60µA at all times. The  $R_S$  value should be large enough to keep  $I_{SHUNT}$  less than 15mA for proper regulation when  $V_S$  is maximum and  $I_{LOAD}$  is at a minimum. To prevent damage to the device,  $I_{SHUNT}$  should never exceed 20mA.

Therefore, the value of  $R_S$  is bounded by the following equation:

$$\frac{[V_S(\text{MIN}) - V_R]}{[60\mu\text{A} + I_{LOAD}(\text{MAX})]} > R_S > \frac{[V_S(\text{MAX}) - V_R]}{[20\text{mA} + I_{LOAD}(\text{MIN})]}$$

Choosing a larger resistance minimizes the total power dissipation in the circuit by reducing the shunt current ( $P_{D(TOTAL)} = V_S \times I_{SHUNT}$ ). Provide a safety margin to incorporate the worst-case tolerance of the resistor used. Ensure that the resistor's power rating is adequate, using the following general power equation:

$$P_{DR} = I_{SHUNT} \times (V_S(\text{MAX}) - V_{SHUNT})$$

## Output Capacitance

The LM4040 does not require an external capacitor for frequency stability and is stable for any output capacitance.

## Temperature Performance

The LM4040 typically exhibits an output voltage temperature coefficient within  $\pm 15\text{ppm}/^\circ\text{C}$ . The polarity of the temperature coefficient may be different from one device to another; some may have positive coefficients, and others may have negative coefficients.

## High Temperature Operation

The maximum junction temperature of the LM4040 is  $+150^\circ\text{C}$ . The maximum operating temperature for the LM4040\_E\_ is  $+125^\circ\text{C}$ . At a maximum load current of 15mA and a maximum output voltage of 5V, the part will dissipate 75mW of power. The power dissipation limits of the 3-pin SC70 call for a derating value of 2.17mW/ $^\circ\text{C}$  above  $+70^\circ\text{C}$  and thus for 75mW of power dissipation, the part will self-heat to  $35.56^\circ\text{C}$  above ambient temperature. If the ambient temperature is  $+125^\circ\text{C}$ , the part operates at  $159.56^\circ\text{C}$ , thereby exceeding the maximum junction temperature value of  $+150^\circ\text{C}$ . For high-temperature operation, care must be taken to ensure the combination of ambient temperature, output power dissipation and package thermal resistance does not conspire to raise the device temperature beyond that listed in the *Absolute Maximum Ratings*. Either reduce the output load current or the ambient temperature to keep the part within the limits.

## Chip Information

TRANSISTOR COUNT: 60

PROCESS: BiCMOS

# Improved Precision Micropower Shunt Voltage Reference with Multiple Reverse Breakdown Voltages

**LM4040**

## Ordering Information

PART	OUTPUT VOLTAGE (V)	INITIAL ACCURACY (%)	TEMPCO (ppm/°C)	TEMP RANGE	PIN-PACKAGE	TOP MARK
LM4040AIM3-2.1-T	2.048	0.1	100	-40°C to +85°C	3 SOT23-3	FZEF
LM4040AIX3-2.1-T	2.048	0.1	100	-40°C to +85°C	3 SC70-3	ABJ
LM4040BIM3-2.1-T	2.048	0.2	100	-40°C to +85°C	3 SOT23-3	FZEG
LM4040BIX3-2.1-T	2.048	0.2	100	-40°C to +85°C	3 SC70-3	ABK
LM4040CIM3-2.1-T	2.048	0.5	100	-40°C to +85°C	3 SOT23-3	FZEH
LM4040CIX3-2.1-T	2.048	0.5	100	-40°C to +85°C	3 SC70-3	ABL
LM4040DIM3-2.1-T	2.048	1.0	150	-40°C to +85°C	3 SOT23-3	FZEI
LM4040DIX3-2.1-T	2.048	1.0	150	-40°C to +85°C	3 SC70-3	ABM
LM4040AEM3-2.1-T	2.048	0.1	100	-40°C to +125°C	3 SOT23-3	FZNG
LM4040AEX3-2.1-T	2.048	0.1	100	-40°C to +125°C	3 SC70-3	ALF
LM4040BEM3-2.1-T	2.048	0.2	100	-40°C to +125°C	3 SOT23-3	FZNH
LM4040BEX3-2.1-T	2.048	0.2	100	-40°C to +125°C	3 SC70-3	ALG
LM4040CEM3-2.1-T	2.048	0.5	100	-40°C to +125°C	3 SOT23-3	FZNI
LM4040CEX3-2.1-T	2.048	0.5	100	-40°C to +125°C	3 SC70-3	ALH
LM4040DEM3-2.1-T	2.048	1.0	150	-40°C to +125°C	3 SOT23-3	FZNJ
LM4040DEX3-2.1-T	2.048	1.0	150	-40°C to +125°C	3 SC70-3	ALI
LM4040AIM3-2.5-T	2.500	0.1	100	-40°C to +85°C	3 SOT23-3	FZEJ
LM4040AIX3-2.5-T	2.500	0.1	100	-40°C to +85°C	3 SC70-3	ABN
LM4040BIM3-2.5-T	2.500	0.2	100	-40°C to +85°C	3 SOT23-3	FZEK
LM4040BIX3-2.5-T	2.500	0.2	100	-40°C to +85°C	3 SC70-3	ABO
LM4040CIM3-2.5-T	2.500	0.5	100	-40°C to +85°C	3 SOT23-3	FZEL
LM4040CIX3-2.5-T	2.500	0.5	100	-40°C to +85°C	3 SC70-3	ABP
LM4040DIM3-2.5-T	2.500	1.0	150	-40°C to +85°C	3 SOT23-3	FZEM
LM4040DIX3-2.5-T	2.500	1.0	150	-40°C to +85°C	3 SC70-3	ABQ
LM4040AEM3-2.5-T	2.500	0.1	100	-40°C to +125°C	3 SOT23-3	FZNK
LM4040AEX3-2.5-T	2.500	0.1	100	-40°C to +125°C	3 SC70-3	ALJ
LM4040BEM3-2.5-T	2.500	0.2	100	-40°C to +125°C	3 SOT23-3	FZNL
LM4040BEX3-2.5-T	2.500	0.2	100	-40°C to +125°C	3 SC70-3	ALK
LM4040CEM3-2.5-T	2.500	0.5	100	-40°C to +125°C	3 SOT23-3	FZNM
LM4040CEX3-2.5-T	2.500	0.5	100	-40°C to +125°C	3 SC70-3	ALL
LM4040DEM3-2.5-T	2.500	1.0	150	-40°C to +125°C	3 SOT23-3	FZNN
LM4040DEX3-2.5-T	2.500	1.0	150	-40°C to +125°C	3 SC70-3	ALM
LM4040AIM3-3.0-T	3.000	0.1	100	-40°C to +85°C	3 SOT23-3	FZEN
LM4040AIX3-3.0-T	3.000	0.1	100	-40°C to +85°C	3 SC70-3	ABR
LM4040BIM3-3.0-T	3.000	0.2	100	-40°C to +85°C	3 SOT23-3	FZEO
LM4040BIX3-3.0-T	3.000	0.2	100	-40°C to +85°C	3 SC70-3	ABS
LM4040CIM3-3.0-T	3.000	0.5	100	-40°C to +85°C	3 SOT23-3	FZEP
LM4040CIX3-3.0-T	3.000	0.5	100	-40°C to +85°C	3 SC70-3	ABT
LM4040DIM3-3.0-T	3.000	1.0	150	-40°C to +85°C	3 SOT23-3	FZEQ
LM4040DIX3-3.0-T	3.000	1.0	150	-40°C to +85°C	3 SC70-3	ABU
LM4040AEM3-3.0-T	3.000	0.1	100	-40°C to +125°C	3 SOT23-3	FZNO
LM4040AEX3-3.0-T	3.000	0.1	100	-40°C to +125°C	3 SC70-3	ALN
LM4040BEM3-3.0-T	3.000	0.2	100	-40°C to +125°C	3 SOT23-3	FZNP
LM4040BEX3-3.0-T	3.000	0.2	100	-40°C to +125°C	3 SC70-3	ALO
LM4040CEM3-3.0-T	3.000	0.5	100	-40°C to +125°C	3 SOT23-3	FZNQ

# Improved Precision Micropower Shunt Voltage Reference with Multiple Reverse Breakdown Voltages

## Ordering Information (continued)

PART	OUTPUT VOLTAGE (V)	INITIAL ACCURACY (%)	TEMPCO (ppm/°C)	TEMP RANGE	PIN-PACKAGE	TOP MARK
LM4040CEX3-3.0-T	3.000	0.5	100	-40°C to +125°C	3 SC70-3	ALP
LM4040DEM3-3.0-T	3.000	1.0	150	-40°C to +125°C	3 SOT23-3	FZNR
LM4040DEX3-3.0-T	3.000	1.0	150	-40°C to +125°C	3 SC70-3	ALQ
LM4040AEX3-3.3-T	3.300	0.1	100	-40°C to +125°C	3 SC70-3	ANY
LM4040BEX3-3.3-T	3.300	0.2	100	-40°C to +125°C	3 SC70-3	ANZ
LM4040CEX3-3.3-T	3.300	0.5	100	-40°C to +125°C	3 SC70-3	AOA
LM4040DEX3-3.3-T	3.300	1.0	150	-40°C to +125°C	3 SC70-3	AOB
LM4040AIM3-4.1-T	4.096	0.1	100	-40°C to +85°C	3 SOT23-3	FZER
LM4040AIX3-4.1-T	4.096	0.1	100	-40°C to +85°C	3 SC70-3	ABV
LM4040BIM3-4.1-T	4.096	0.2	100	-40°C to +85°C	3 SOT23-3	FZES
LM4040BIX3-4.1-T	4.096	0.2	100	-40°C to +85°C	3 SC70-3	ABW
LM4040CIM3-4.1-T	4.096	0.5	100	-40°C to +85°C	3 SOT23-3	FZET
LM4040CIX3-4.1-T	4.096	0.5	100	-40°C to +85°C	3 SC70-3	ABX
LM4040DIM3-4.1-T	4.096	1.0	150	-40°C to +85°C	3 SOT23-3	FZEU
LM4040DIX3-4.1-T	4.096	1.0	150	-40°C to +85°C	3 SC70-3	ABY
LM4040AEM3-4.1-T	4.096	0.1	100	-40°C to +125°C	3 SOT23-3	FZNS
LM4040AEX3-4.1-T	4.096	0.1	100	-40°C to +125°C	3 SC70-3	ALR
LM4040BEM3-4.1-T	4.096	0.2	100	-40°C to +125°C	3 SOT23-3	FZNT
LM4040BEX3-4.1-T	4.096	0.2	100	-40°C to +125°C	3 SC70-3	ALS
LM4040CEM3-4.1-T	4.096	0.5	100	-40°C to +125°C	3 SOT23-3	FZNU
LM4040CEX3-4.1-T	4.096	0.5	100	-40°C to +125°C	3 SC70-3	ALT
LM4040DEM3-4.1-T	4.096	1.0	150	-40°C to +125°C	3 SOT23-3	FZNV
LM4040DEX3-4.1-T	4.096	1.0	150	-40°C to +125°C	3 SC70-3	ALU
LM4040AIM3-5.0-T	5.000	0.1	100	-40°C to +85°C	3 SOT23-3	FZEV
LM4040AIX3-5.0-T	5.000	0.1	100	-40°C to +85°C	3 SC70-3	ABZ
LM4040BIM3-5.0-T	5.000	0.2	100	-40°C to +85°C	3 SOT23-3	FZEW
LM4040BIX3-5.0-T	5.000	0.2	100	-40°C to +85°C	3 SC70-3	ACA
LM4040CIM3-5.0-T	5.000	0.5	100	-40°C to +85°C	3 SOT23-3	FZEX
LM4040CIX3-5.0-T	5.000	0.5	100	-40°C to +85°C	3 SC70-3	ACB
LM4040DIM3-5.0-T	5.000	1.0	150	-40°C to +85°C	3 SOT23-3	FZEY
LM4040DIX3-5.0-T	5.000	1.0	150	-40°C to +85°C	3 SC70-3	ACC
LM4040AEM3-5.0-T	5.000	0.1	100	-40°C to +125°C	3 SOT23-3	FZNW
LM4040AEX3-5.0-T	5.000	0.1	100	-40°C to +125°C	3 SC70-3	ALV
LM4040BEM3-5.0-T	5.000	0.2	100	-40°C to +125°C	3 SOT23-3	FZNX
LM4040BEX3-5.0-T	5.000	0.2	100	-40°C to +125°C	3 SC70-3	ALW
LM4040CEM3-5.0-T	5.000	0.5	100	-40°C to +125°C	3 SOT23-3	FZNY
LM4040CEX3-5.0-T	5.000	0.5	100	-40°C to +125°C	3 SC70-3	ALX

**LM4040**

# Improved Precision Micropower Shunt Voltage Reference with Multiple Reverse Breakdown Voltages

## Package Information

(The package drawing(s) in this data sheet may not reflect the most current specifications. For the latest package outline information, go to [www.maxim-ic.com/packages](http://www.maxim-ic.com/packages).)

**NOTES:**

1. D&E DO NOT INCLUDE MOLD FLASH.
  2. MOLD FLASH OR PROTRUSIONS NOT TO EXCEED .15mm (.006").
  3. CONTROLLING DIMENSION: MILLIMETERS.
  4. REFERENCE JEDEC TO236-VARIATION AB.
  5. LEADS TO BE COPLANAR WITHIN 0.10mm.
- △ DIMENSIONS MEASURED AT FLAT SECTION OF LEAD BETWEEN 0.08mm AND 0.15mm FROM LEAD TIP.

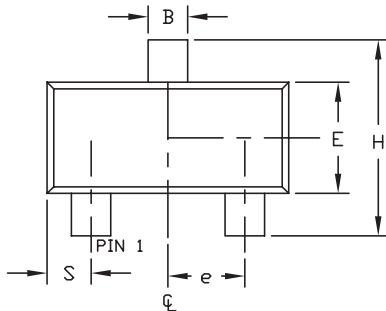

TOP VIEW

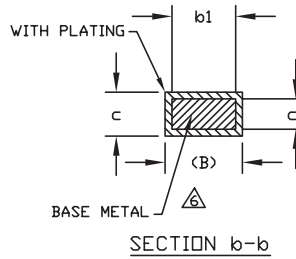

SECTION b-b

DIM	INCHES		MILLIMETERS	
	MIN	MAX	MIN	MAX
A	0.035	0.044	0.890	1.120
A1	0.001	0.004	0.013	0.100
B	0.015	0.020	0.370	0.500
b1	0.012	0.018	0.300	0.450
c	0.003	0.071	0.085	0.180
c1	0.003	0.071	0.080	0.160
D	0.110	0.120	2.800	3.040
E	0.047	0.055	1.200	1.400
e	0.037	BSC.	0.950	BSC.
e1	0.075	BSC.	1.900	BSC.
H	0.083	0.104	2.100	2.640
L	0.015	0.023	0.400	0.600
L1	0.021	REF	0.54	REF
S	0.018	0.024	0.45	0.60
α	0°	8°	0°	8°

DETAIL "A"

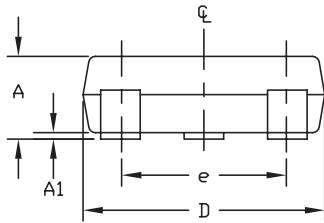
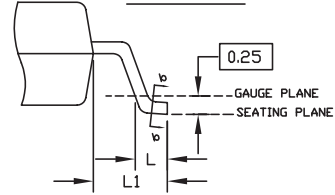

FRONT VIEW

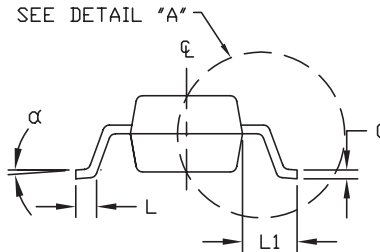

SIDE VIEW

**DALLAS SEMICONDUCTOR** **MAXIM**  
 PROPRIETARY INFORMATION  
 TITLE: PACKAGE OUTLINE, 3L SOT-23  
 APPROVAL: \_\_\_\_\_ DOCUMENT CONTROL NO. 21-0051 REV. F 1/1

SOT23 LEP'S

# Improved Precision Micropower Shunt Voltage Reference with Multiple Reverse Breakdown Voltages

## Package Information (continued)

(The package drawing(s) in this data sheet may not reflect the most current specifications. For the latest package outline information, go to [www.maxim-ic.com/packages](http://www.maxim-ic.com/packages).)

**LM4040**

SC70, 3LEPS

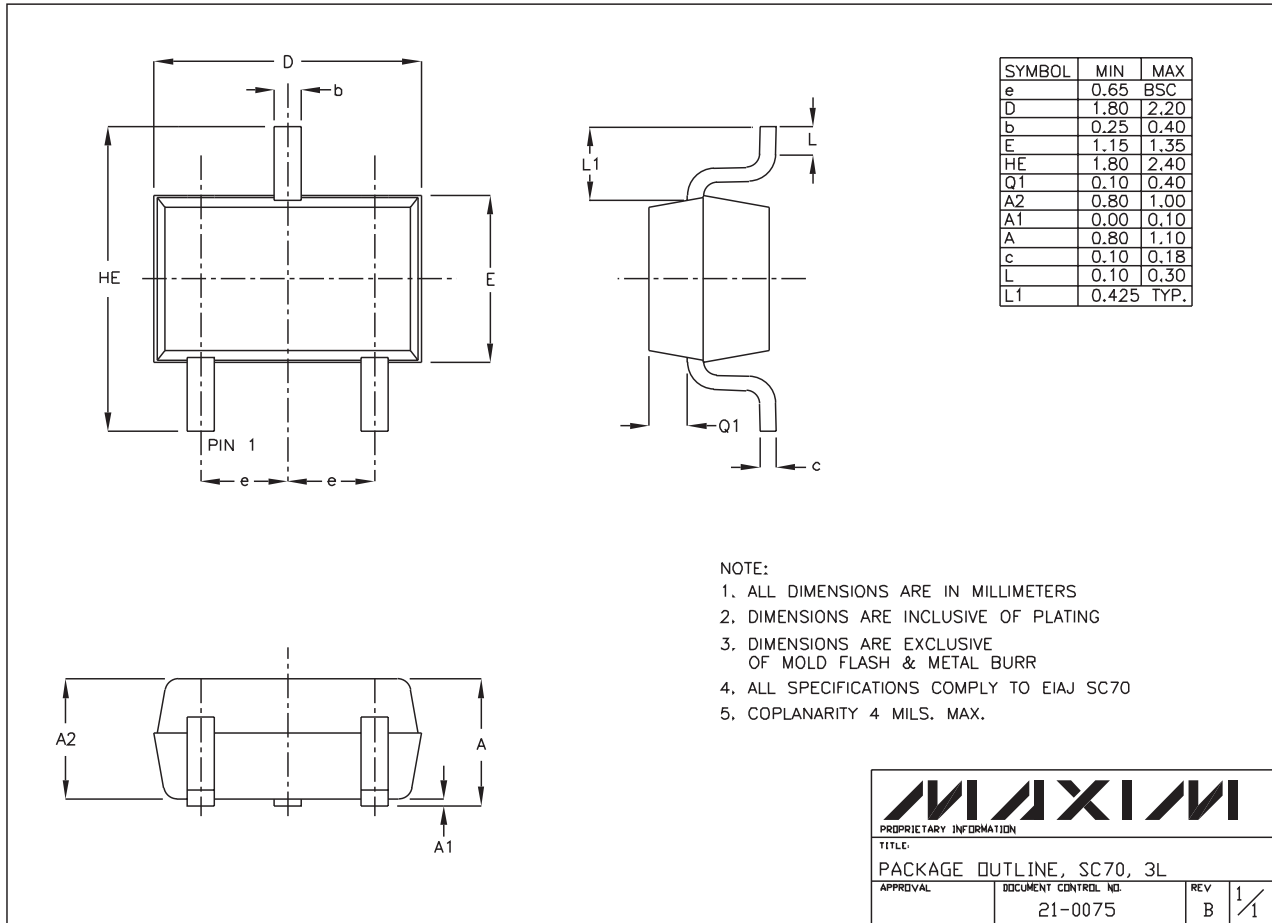

Maxim cannot assume responsibility for use of any circuitry other than circuitry entirely embodied in a Maxim product. No circuit patent licenses are implied. Maxim reserves the right to change the circuitry and specifications without notice at any time.

15 **Maxim Integrated Products, 120 San Gabriel Drive, Sunnyvale, CA 94086 408-737-7600**