

EVALUATION KIT  
AVAILABLE



# ISDB-T Single-Segment Low-IF Tuners

## General Description

The MAX2160/EBG tuner ICs are designed for use in Japanese mobile digital TV (ISDB-T single-segment) applications. The devices directly convert UHF band signals to a low-IF using a broadband I/Q downconverter. The operating frequency range extends from 470MHz to 770MHz.

The MAX2160/EBG support both I/Q low-IF interfaces as well as single low-IF interfaces, making the devices universal tuners for various digital demodulator IC implementations.

The MAX2160/EBG include an LNA, RF variable-gain amplifiers, I and Q downconverting mixers, low-IF variable-gain amplifiers, and bandpass filters providing in excess of 42dB of image rejection. The parts are capable of operating with either high-side or low-side local oscillator (LO) injection. The MAX2160/EBG's variable-gain amplifiers provide in excess of 100dB of gain-control range.

The MAX2160/EBG also include fully monolithic VCOs and tank circuits, as well as a complete frequency synthesizer. The devices include a XTAL oscillator as well as a separate TCXO input buffer. The devices operate with XTAL/TCXO oscillators from 13MHz to 26MHz allowing the shared use of a VC-TCXO in cellular handset applications. Additionally, a divider is provided for the XTAL/TCXO oscillator allowing for simple and low-cost interfacing to various channel decoders.

The MAX2160/EBG are specified for operation from -40°C to +85°C and available in a 40-pin thin QFN lead-free plastic package with exposed paddle (EP), and in a lead-free wafer-level package (WLP).

## Applications

Cell Phone Mobile TVs  
Personal Digital Assistants (PDAs)  
Pocket TVs

## Ordering Information

PART	TEMP RANGE	PIN-PACKAGE	PKG CODE
MAX2160ETL	-40°C to +85°C	40 Thin QFN-EP** (6mm x 6mm)	T4066-2
MAX2160ETL+	-40°C to +85°C	40 Thin QFN-EP** (6mm x 6mm)	T4066-2
MAX2160EBG+	-40°C to +85°C	WLP (3.175mm x 3.175mm)	B08133+1

+Denotes lead-free package.

\*\*EP = Exposed paddle.

## Features

- ◆ Low Noise Figure: < 4dB Typical
- ◆ High Dynamic Range: -98dBm to 0dBm
- ◆ High-Side or Low-Side LO Injection
- ◆ Integrated VCO and Tank Circuits
- ◆ Low LO Phase Noise: Typical -88dBc/Hz at 10kHz
- ◆ Integrated Frequency Synthesizer
- ◆ Integrated Bandpass Filters
- ◆ 52dB Typical Image Rejection
- ◆ Single +2.7V to +3.3V Supply Voltage
- ◆ Three Low-Power Modes
- ◆ Two-Wire, I<sup>2</sup>C\*-Compatible Serial Control Interface
- ◆ Very Small Lead-Free WLP Package

## Pin Configurations/ Functional Diagrams

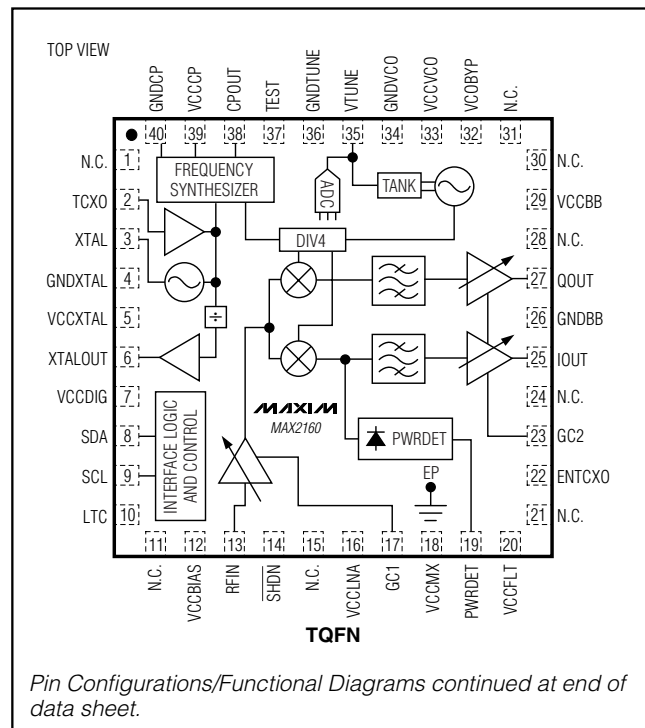

\*Purchase of I<sup>2</sup>C components from Maxim Integrated Products Inc., or one of its sublicensed Associated Companies, conveys a license under the Philips I<sup>2</sup>C Patent Rights to use these components in an I<sup>2</sup>C system, provided that the system conforms to the I<sup>2</sup>C Standard Specification as defined by Philips.



# ISDB-T Single-Segment Low-IF Tuners

## ABSOLUTE MAXIMUM RATINGS

All VCC_ Pins to GND.....	-0.3V to +3.6V
All Other Pins to GND.....	-0.3V to (VCC + 0.3V)
RFIN, Maximum RF Input Power .....	+10dBm
ESD Rating .....	1kV
Short-Circuit Duration	
IOOUT, QOUT, CPOUT, XTALOUT, PWRDET, SDA, TEST, LTC, VCOBYP .....	10s

Continuous Power Dissipation (T <sub>A</sub> = +70°C)	
40-Pin Thin QFN (derate 35.7mW/°C above +70°C).....	2857mW
WLP (derate 10.8mW/°C above +70°C).....	704mW
Operating Temperature Range .....	-40°C to +85°C
Junction Temperature .....	+150°C
Storage Temperature Range .....	-65°C to +150°C
Lead Temperature (soldering, 10s).....	+300°C



**CAUTION!** ESD SENSITIVE DEVICE

Stresses beyond those listed under "Absolute Maximum Ratings" may cause permanent damage to the device. These are stress ratings only, and functional operation of the device at these or any other conditions beyond those indicated in the operational sections of the specifications is not implied. Exposure to absolute maximum rating conditions for extended periods may affect device reliability.

## DC ELECTRICAL CHARACTERISTICS

(MAX2160 EV kit, V<sub>CC</sub> = +2.7V to +3.3V, V<sub>GC1</sub> = V<sub>GC2</sub> = 0.3V (maximum gain), no RF input signals at RFIN, baseband I/Os are open circuited and VCO is active with f<sub>LO</sub> = 767.714MHz, registers set according to the recommended default register conditions of Tables 2-11, T<sub>A</sub> = -40°C to +85°C, unless otherwise noted. Typical values are at V<sub>CC</sub> = +2.85V, T<sub>A</sub> = +25°C, unless otherwise noted.) (Note 1)

PARAMETER	CONDITIONS	MIN	TYP	MAX	UNITS
<b>SUPPLY</b>					
Supply Voltage		2.7	2.85	3.3	V
Supply Current (See Tables 15 and 16)	Receive mode, $\overline{\text{SHDN}} = \text{VCC}$ , BBL[1:0] = 00		44	53.5	mA
	Standby mode, bit STBY = 1		2	4	
	Power-down mode, bit PWDN = 1, EPD = 0		5	40	μA
	Shutdown mode, $\overline{\text{SHDN}} = \text{GND}$		0	10	
<b>ANALOG GAIN-CONTROL INPUTS (GC1, GC2)</b>					
Input Voltage Range	Maximum gain = 0.3V	0.3		2.7	V
Input Bias Current		-15		+15	μA
<b>VCO TUNING VOLTAGE INPUT (VTUNE)</b>					
Input Voltage Range		0.4		2.3	V
<b>VTUNE ADC</b>					
Resolution			3		bits
Input Voltage Range		0.3		2.4	V
Reference Ladder Trip Point	ADC read bits	110 to 111	V <sub>CC</sub> - 0.4		V
		101 to 110	1.9		
		100 to 101	1.7		
		011 to 100	1.3		
		010 to 011	0.9		
		001 to 010	0.6		
		000 to 001	0.4		
<b>LOCK TIME CONSTANT OUTPUT (LTC)</b>					
Source Current	Bit LTC = 0		1		μA
	Bit LTC = 1		2		

# ISDB-T Single-Segment Low-IF Tuners

MAX2160/MAX2160EBG

## DC ELECTRICAL CHARACTERISTICS (continued)

(MAX2160 EV kit,  $V_{CC} = +2.7V$  to  $+3.3V$ ,  $V_{GC1} = V_{GC2} = 0.3V$  (maximum gain), no RF input signals at RFIN, baseband I/Os are open circuited and VCO is active with  $f_{LO} = 767.714MHz$ , registers set according to the recommended default register conditions of Tables 2-11,  $T_A = -40^{\circ}C$  to  $+85^{\circ}C$ , unless otherwise noted. Typical values are at  $V_{CC} = +2.85V$ ,  $T_A = +25^{\circ}C$ , unless otherwise noted.) (Note 1)

PARAMETER	CONDITIONS	MIN	TYP	MAX	UNITS
<b>SHUTDOWN CONTROL (SHDN)</b>					
Input-Logic-Level High		0.7 x $V_{CC}$			V
Input-Logic-Level Low			0.3 x $V_{CC}$		V
<b>2-WIRE SERIAL INPUTS (SCL, SDA)</b>					
Clock Frequency			400		kHz
Input-Logic-Level High		0.7 x $V_{CC}$			V
Input-Logic-Level Low			0.3 x $V_{CC}$		V
Input Leakage Current	Digital inputs = GND or $V_{CC}$		$\pm 0.1$	$\pm 1$	$\mu A$
<b>2-WIRE SERIAL OUTPUT (SDA)</b>					
Output-Logic-Level Low			0.2		V

## AC ELECTRICAL CHARACTERISTICS

(MAX2160 EV kit,  $V_{CC} = +2.7V$  to  $+3.3V$ ,  $f_{RF} = 767.143MHz$ ,  $f_{LO} = 767.714MHz$ ,  $f_{BB} = 571kHz$ ,  $f_{XTAL} = 16MHz$ ,  $V_{GC1} = V_{GC2} = 0.3V$  (maximum gain), registers set according to the recommended default register conditions of Tables 2-11, RF input signals as specified, baseband output load as specified,  $T_A = -40^{\circ}C$  to  $+85^{\circ}C$ , unless otherwise noted. Typical values are at  $V_{CC} = +2.85V$ ,  $T_A = +25^{\circ}C$ , unless otherwise noted.) (Note 1)

PARAMETER	CONDITIONS	MIN	TYP	MAX	UNITS
<b>MAIN SIGNAL PATH PERFORMANCE</b>					
Input Frequency Range		470		770	MHz
Minimum Input Signal	13-segment input		-98		dBm
Maximum Voltage Gain	CW tone, $V_{GC1} = V_{GC2} = 0.3V$ , bit MOD = 1	104			dB
Minimum Voltage Gain	CW tone, $V_{GC1} = V_{GC2} = 2.7V$ , bit MOD = 0			2	dB
RF Gain-Control Range	$0.3V < V_{GC1} < 2.7V$	38	43		dB
Baseband Gain-Control Range	$0.3V < V_{GC2} < 2.7V$	57	67		dB
In-Band Input IP3	(Note 2)		+4		dBm
Out-of-Band Input IP3	(Note 3)		+16.7		dBm
Input IP2	(Note 4)		+16		dBm
Input $P_{1dB}$	CW tone, $V_{GC1} = V_{GC2} = 2.7V$ , bit MOD = 0		0		dBm
Noise Figure	$V_{GC1} = V_{GC2} = 0.3V$ , $T_A = +25^{\circ}C$ (Note 5)		3.8	5	dB
Image Rejection		42	52		dB
Minimum RF Input Return Loss	$f_{RF} = 620MHz$ , $50\Omega$ system		14		dB
LO Leakage at RFIN			-100		dBm
<b>IF POWER DETECTOR</b>					
Resolution			3		bits
Minimum RF Attack Point	Power at RFIN		-62		dBm
Maximum RF Attack Point	Power at RFIN		-48		dBm
Detector Bandwidth	3dB RF bandwidth		$\pm 35$		MHz
Output Compliance Range		0.3		2.7	V
Response Time	$C_{14} = 10nF$		0.1		ms

# ISDB-T Single-Segment Low-IF Tuners

## AC ELECTRICAL CHARACTERISTICS (continued)

(MAX2160 EV kit,  $V_{CC} = +2.7V$  to  $+3.3V$ ,  $f_{RF} = 767.143MHz$ ,  $f_{LO} = 767.714MHz$ ,  $f_{BB} = 571kHz$ ,  $f_{XTAL} = 16MHz$ ,  $V_{GC1} = V_{GC2} = 0.3V$  (maximum gain), registers set according to the recommended default register conditions of Tables 2–11, RF input signals as specified, baseband output load as specified,  $T_A = -40^{\circ}C$  to  $+85^{\circ}C$ , unless otherwise noted. Typical values are at  $V_{CC} = +2.85V$ ,  $T_A = +25^{\circ}C$ , unless otherwise noted.) (Note 1)

PARAMETER	CONDITIONS	MIN	TYP	MAX	UNITS
<b>LOW-IF BANDPASS FILTERS</b>					
Center Frequency			571		kHz
Frequency Response (Note 5)	$\pm 380kHz$ offset from center frequency	-6		-1.5	dB
	1.3MHz		-36		
Group Delay Variation	Up to 1dB bandwidth		$\pm 100$		ns
<b>BASEBAND OUTPUT CHARACTERISTICS</b>					
Nominal Output-Voltage Swing	$R_{LOAD} = 10k\Omega \parallel 10pF$		0.5		$V_{P-P}$
I/Q Amplitude Imbalance	(Note 6)			$\pm 1.5$	dB
I/Q Quadrature Phase Imbalance				$\pm 2$	deg
Output Gain Step	Bit MOD transition from 0 to 1		+7		dB
I/Q Output Impedance	Real $Z_O$		30		$\Omega$
<b>FREQUENCY SYNTHESIZER</b>					
RF-Divider Frequency Range		470		770	MHz
RF-Divider Range (N)		829		5374	
Reference-Divider Frequency Range		13		26	MHz
Reference-Divider Range (R)		22		182	
Phase-Detector Comparison Frequency		1/7		4/7	MHz
PLL-Referred Phase Noise Floor	$T_A = +25^{\circ}C$ , $f_{COMP} = 285.714kHz$		-155		dBc/Hz
Comparison Frequency Spurious Products	Bit EPB = 1		-52		dBc
Charge-Pump Output Current (Note 5)	Bits CP[1:0] = 00	1.25	1.5	1.75	mA
	Bits CP[1:0] = 01	1.75	2.0	2.25	
	Bits CP[1:0] = 10	2.10	2.5	2.90	
	Bits CP[1:0] = 11	2.50	3	3.50	
Charge-Pump Compliance Range	$\pm 10\%$ variation from current at VTUNE = 1.35V	0.4		2.2	V
Charge-Pump Source/Sink Current Matching	VTUNE = 1.35V	-10		+10	%

# ISDB-T Single-Segment Low-IF Tuners

MAX2160/MAX2160EBG

## AC ELECTRICAL CHARACTERISTICS (continued)

(MAX2160 EV kit,  $V_{CC} = +2.7V$  to  $+3.3V$ ,  $f_{RF} = 767.143MHz$ ,  $f_{LO} = 767.714MHz$ ,  $f_{BB} = 571kHz$ ,  $f_{XTAL} = 16MHz$ ,  $V_{GC1} = V_{GC2} = 0.3V$  (maximum gain), registers set according to the recommended default register conditions of Tables 2–11, RF input signals as specified, baseband output load as specified,  $T_A = -40^{\circ}C$  to  $+85^{\circ}C$ , unless otherwise noted. Typical values are at  $V_{CC} = +2.85V$ ,  $T_A = +25^{\circ}C$ , unless otherwise noted.) (Note 1)

PARAMETER	CONDITIONS	MIN	TYP	MAX	UNITS
<b>VOLTAGE-CONTROLLED OSCILLATOR AND LO GENERATION</b>					
Guaranteed VCO Frequency Range	$T_A = -40^{\circ}C$ to $+85^{\circ}C$	1880		3080	MHz
Guaranteed LO Frequency Range	$T_A = -40^{\circ}C$ to $+85^{\circ}C$	470		770	MHz
Tuning Voltage Range		0.4		2.3	V
LO Phase Noise	$0.4V < V_{TUNE} < 2.3V$ , $T_A = -40^{\circ}C$ to $+85^{\circ}C$	$f_{OFFSET} = 1kHz$		-80	dBc/Hz
		$f_{OFFSET} = 10kHz$		-87.5	
		$f_{OFFSET} = 100kHz$		-107	
		$f_{OFFSET} = 1MHz$		-128	
<b>XTAL OSCILLATOR INPUT (TCXO AND XTAL)</b>					
XTAL Oscillator Frequency Range	Parallel resonance mode crystal	13		26	MHz
XTAL Minimum Negative Resistance	$16MHz < f_{XTAL} < 18MHz$ (Note 5)		885		$\Omega$
XTAL Nominal Input Capacitance			13.3		pF
TCXO Input Level	AC-coupled sine-wave input	0.4		1.5	V <sub>P-P</sub>
TCXO Minimum Input Impedance			10		k $\Omega$
<b>REFERENCE OSCILLATOR BUFFER OUTPUT (XTALOUT)</b>					
Output Frequency Range		1		26	MHz
Output-Buffer Divider Range		1		26	
Output-Voltage Swing			0.7		V <sub>P-P</sub>
Output Load			200    4		k $\Omega$    pF
Output Duty Cycle			50		%
Output Impedance			160		$\Omega$

- Note 1:** Min and max values are production tested at  $T_A = +25^{\circ}C$  and  $+85^{\circ}C$ . Min and max limits at  $T_A = -40^{\circ}C$  are guaranteed by design and characterization. Default register settings are not production tested; load all registers no sooner than 100 $\mu$ s after power-up.
- Note 2:** In-band IIP3 is measured with two tones at  $f_{LO} - 100kHz$  and  $f_{LO} - 200kHz$  at a power level of -23dBm/tone. GC1 is set for maximum attenuation ( $V_{GC1} = 2.7V$ ) and GC2 is adjusted to achieve 250mV<sub>P-P</sub>/tone at the I/Q outputs for an input desired level of -23dBm.
- Note 3:** Out-of-band IIP3 is measured with two tones at  $f_{RF} + 6MHz$  and  $f_{RF} + 12MHz$  at a power level of -15dBm/tone. GC1 is set for maximum attenuation ( $V_{GC1} = 2.7V$ ) and GC2 is adjusted to achieve 0.5V<sub>P-P</sub> at the I/Q outputs for an input desired level of -50dBm.  $f_{RF}$  is set to  $767MHz + 1/7MHz = 767.143MHz$ .
- Note 4:** GC1 is set for maximum attenuation ( $V_{GC1} = 2.7V$ ). GC2 is adjusted to give the nominal I/Q output voltage level (0.5V<sub>P-P</sub>) for a -50dBm desired tone at  $f_{RF} = 550MHz$ . Two tones, 220MHz and 770MHz at -15dBm/tone, are then injected and the 571kHz IM2 levels are measured (with a 550.571MHz LO) at the I/Q outputs and IP2 is then calculated.
- Note 5:** Guaranteed by design and characterization.
- Note 6:** Guaranteed and tested at  $T_A = +25^{\circ}C$  and  $+85^{\circ}C$  only.

# ISDB-T Single-Segment Low-IF Tuners

## Typical Operating Characteristics

(MAX2160 EV kit, TQFN package,  $V_{CC} = +2.85V$ , default register settings,  $V_{GC1} = V_{GC2} = 0.3V$ ,  $V_{IOUT} = V_{QOUT} = 0.5V_{P-P}$ ,  $f_{LO} = 767.714MHz$ ,  $T_A = +25^\circ C$ , unless otherwise noted.)

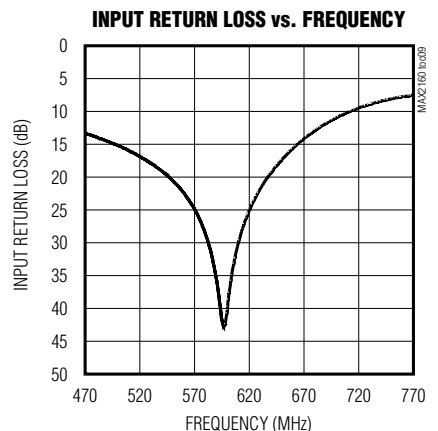
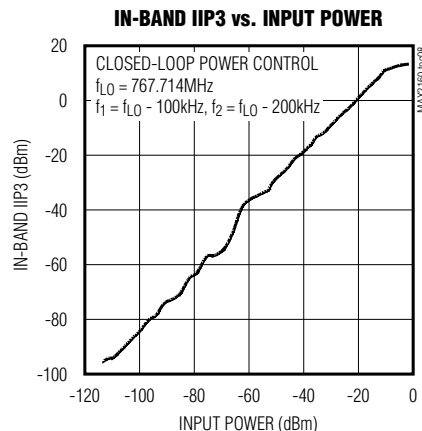
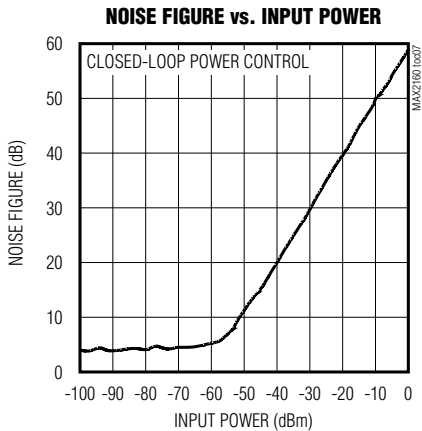
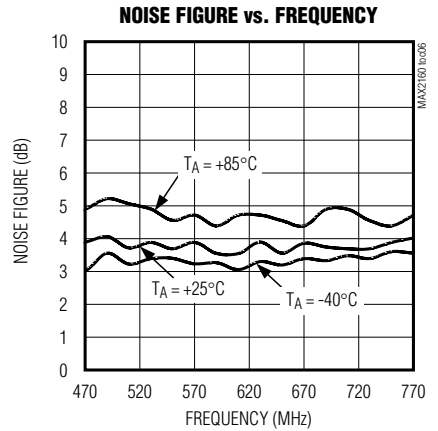
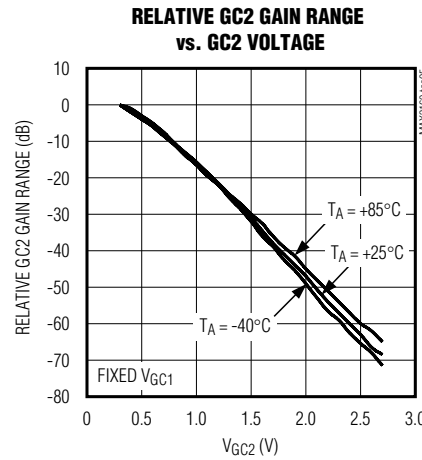
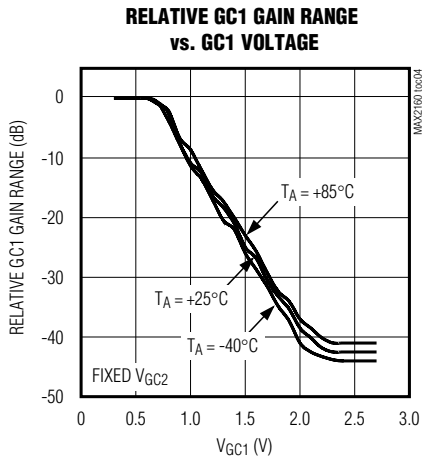
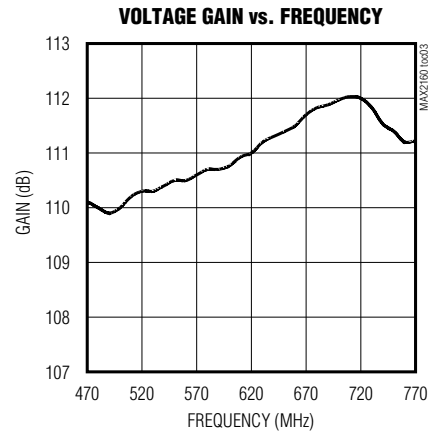
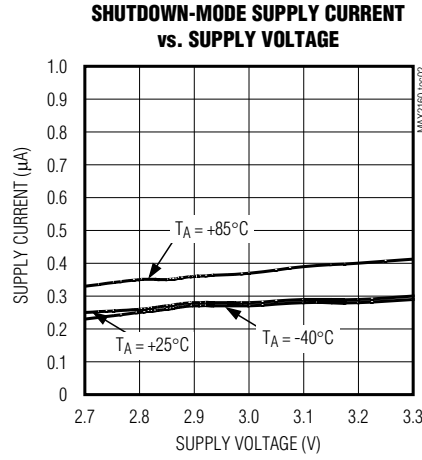
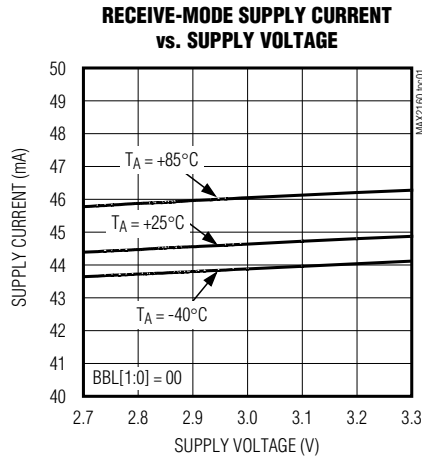

# ISDB-T Single-Segment Low-IF Tuners

## Typical Operating Characteristics (continued)

(MAX2160 EV kit, TQFN package,  $V_{CC} = +2.85V$ , default register settings,  $V_{GC1} = V_{GC2} = 0.3V$ ,  $V_{IOUT} = V_{QOUT} = 0.5V_{P-P}$ ,  $f_{LO} = 767.714MHz$ ,  $T_A = +25^{\circ}C$ , unless otherwise noted.)

MAX2160/MAX2160EBG

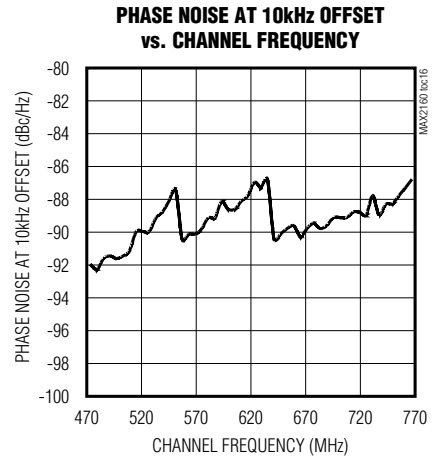
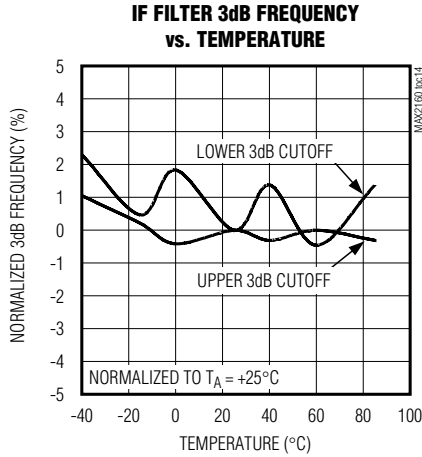
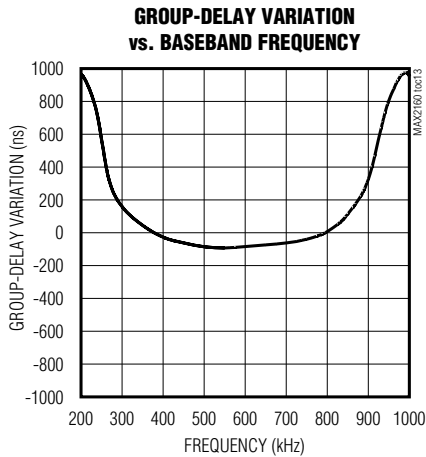
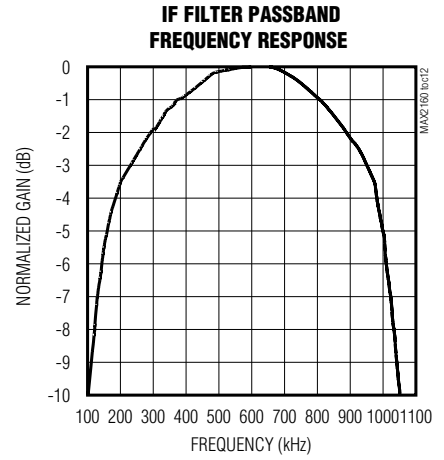
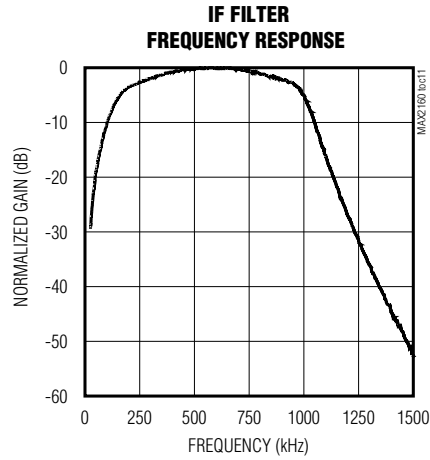
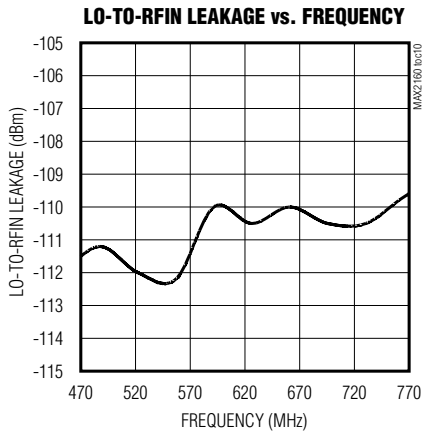

# ISDB-T Single-Segment Low-IF Tuners

## Typical Operating Characteristics (continued)

(MAX2160 EV kit, TQFN package,  $V_{CC} = +2.85V$ , default register settings,  $V_{GC1} = V_{GC2} = 0.3V$ ,  $V_{IOUT} = V_{QOUT} = 0.5VP-P$ ,  $f_{LO} = 767.714MHz$ ,  $T_A = +25^{\circ}C$ , unless otherwise noted.)

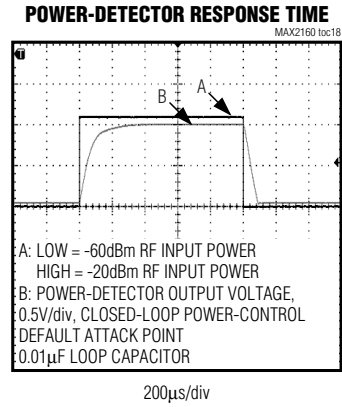
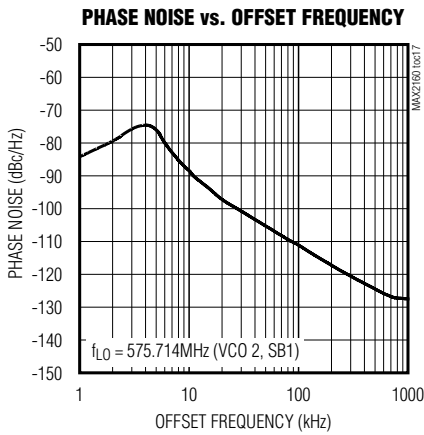
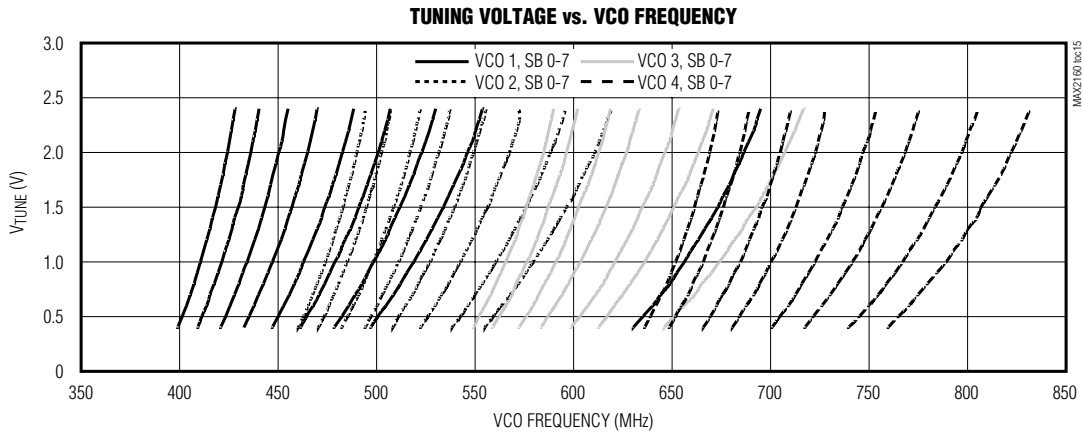



# ISDB-T Single-Segment Low-IF Tuners

## Pin Description

MAX2160/MAX2160EBG

PIN	BUMP NO.	NAME	DESCRIPTION
TQFN	WLP		
1, 11, 15, 21, 24, 28, 30, 31	29, 33, 34, 35, 36, 45, 46	N.C.	No Connection. Connect to the PC board ground plane.
2	2	TCXO	High-Impedance Buffer for External TCXO. When ENTCXO is pulled high, this input is enabled for use with an external TCXO and the internal crystal oscillator is disabled. Requires a DC-blocking capacitor.
3	11	XTAL	Crystal-Oscillator Interface. When ENTCXO is pulled low, this input is enabled for use with an external parallel resonance mode crystal. See the <i>Typical Operating Circuit</i> .
4	—	GNDXTAL	Crystal-Oscillator Circuit Ground. Connect to the PC board ground plane.
5	12	VCCXTAL	DC Power Supply for Crystal-Oscillator Circuits. Connect to a +2.85V low-noise supply. Bypass to GND with a 100pF capacitor connected as close to the pin as possible. Do not share capacitor ground vias with other ground connections.
6	4	XTALOUT	Crystal Oscillator Buffer Output. A DC-blocking capacitor must be used when driving external circuitry.
7	5	VCCDIG	DC Power Supply for Digital Logic Circuits. Connect to a +2.85V low-noise supply. Bypass to GND with a 100pF capacitor connected as close to the pin as possible. Do not share capacitor ground vias with other ground connections.
8	14	SDA	2-Wire Serial Data Interface. Requires a pullup resistor to V <sub>CC</sub> .
9	7	SCL	2-Wire Serial Clock Interface. Requires a pullup resistor to V <sub>CC</sub> .
10	19	LTC	PLL Lock Time Constant. LTC sources current to an external charging capacitor to set the time constant for the VCO autoselect (VAS) function. See the <i>Loop Time Constant Pin</i> section in the <i>Applications Information</i> .
12	9	VCCBIAS	DC Power Supply for Bias Circuits. Connect to a +2.85V low-noise supply. Bypass to GND with a 100pF capacitor connected as close to the pin as possible. Do not share capacitor ground vias with other ground connections.
13	17	RFIN	Wideband 50Ω RF Input. Connect to an RF source through a DC-blocking capacitor.
14	22	$\overline{\text{SHDN}}$	Device Shutdown. Logic-low turns off the entire device including the 2-wire compatible bus. $\overline{\text{SHDN}}$ overrides all software shutdown modes.
16	24	VCCLNA	DC Power Supply for LNA. Connect to a +2.85V low-noise supply. Bypass to GND with a 100pF capacitor connected as close to the pin as possible. Do not share capacitor ground vias with other ground connections.
17	25	GC1	RF Gain-Control Input. High-impedance analog input, with a 0.3V to 2.7V operating range. V <sub>GC1</sub> = 0.3V corresponds to the maximum gain setting.
18	28	VCCMX	DC Power Supply for RF Mixer Circuits. Connect to a +2.85V low-noise supply. Bypass to GND with a 100pF capacitor connected as close to the pin as possible. Do not share capacitor ground vias with other ground connections.
19	38	PWRDET	Power-Detector Output. See the <i>IF Power Detector</i> section in the <i>Applications Information</i> .

# ISDB-T Single-Segment Low-IF Tuners

## Pin Description (continued)

MAX2160/MAX2160EBG

PIN	BUMP NO.	NAME	DESCRIPTION
TQFN	WLP		
20	39	VCCFLT	DC Power Supply for Baseband Filter Circuits. Connect to a +2.85V low-noise supply. Bypass to GND with a 100pF capacitor connected as close to the pin as possible. Do not share capacitor ground vias with other ground connections.
22	37	ENTCXO	XTAL/TCXO Select. Logic-high enables the TCXO input and disables the XTAL input. Logic-low disables the TCXO input and enables the XTAL input. This pin is internally pulled up to V <sub>CC</sub> .
23	47	GC2	Baseband Gain-Control Input. High-impedance analog input, with a 0.3V to 2.7V operating range. V <sub>GC2</sub> = 0.3V corresponds to the maximum gain setting.
25	44	IOUT	In-Phase Low-IF Output. Requires a DC-blocking capacitor.
26	—	GNDDB	Ground for Baseband Circuits. Connect to the PC board ground plane.
27	43	QOUT	Quadrature Low-IF Output. Requires a DC-blocking capacitor.
29	41	VCCBB	DC Power Supply for Baseband Circuits. Connect to a +2.85V low-noise supply. Bypass to GND with a 100pF capacitor connected as close to the pin as possible. Do not share capacitor ground vias with other ground connections.
32	30	VCOBYP	Internal VCO Bias Bypass. Bypass directly to GNDVCO with a 470nF capacitor connected as close to the pin as possible. Do not share capacitor ground vias with other ground connections. See the <i>Layout Considerations</i> section.
33	26	VCCVCO	DC Power Supply for VCO Circuits. Connect to a +2.85V low-noise supply. Bypass directly to GNDVCO with a 100pF capacitor connected as close to the pin as possible. Do not share capacitor ground vias with other ground connections.
34	23	GNDVCO	VCO Circuit Ground. Connect to the PC board ground plane. See the <i>Layout Considerations</i> section.
35	32	VTUNE	High-Impedance VCO Tune Input. Connect the PLL loop filter output directly to this pin with the shortest connection as possible.
36	20	GNDTUNE	Ground for VTUNE. Connect to the PC board ground plane. See the <i>Layout Considerations</i> section.
37	18	TEST	Test Output. Used as a test output for various internal blocks. See Table 2.
38	16	CPOUT	Charge-Pump Output. Connect this output to the PLL loop filter input with the shortest connection possible.
39	10	VCCCP	DC Power Supply for Charge-Pump Circuits. Connect to a +2.85V low-noise supply. Bypass to GND with a 100pF capacitor connected as close to the pin as possible. Do not share capacitor ground vias with other ground connections.
40	1	GNDCP	Charge-Pump Circuit Ground. Connect to the PC board ground plane. See the <i>Layout Considerations</i> section.
EP	—	GND	Exposed Paddle. Solder evenly to the board's ground plane for proper operation.
—	3, 6, 8, 13, 15, 27, 31, 40, 42	GND	Ground. Connect to the PC board ground plane.
—	21	GNDLNA	Ground for LNA. Connect to ground with trace.

# ISDB-T Single-Segment Low-IF Tuners

## Detailed Description

All registers must be written after power-up and no earlier than 100µs after power-up.

### Register Descriptions

The MAX2160/EBG include eight programmable registers and two read-only registers. The eight programma-

ble registers include a test register, a PLL register, a VCO register, a control register, a XTAL divide register, an R-divider register, and two N-divider registers. The read-only registers include two status registers.

**Table 1. Register Configuration**

REGISTER NUMBER	REGISTER NAME	READ/ WRITE	REGISTER ADDRESS	MSB								LSB
				DATA BYTE								
				D7	D6	D5	D4	D3	D2	D1	D0	
1	TEST	WRITE	0x00	TUN2	TUN1	TUN0	FLTS	MXSD	D2	D1	D0	
2	PLL	WRITE	0x01	CP1	CP0	CPS	EPB	RPD	NPD	TON	VAS	
3	VCO	WRITE	0x02	VCO1	VCO0	VSB2	VSB1	VSB0	ADL	ADE	LTC	
4	CONTROL	WRITE	0x03	MOD	BBL1	BBL0	HSL5	PD2	PD1	PD0	EPD	
5	XTAL DIVIDE	WRITE	0x04	XD4	XD3	XD2	XD1	XD0	PWDN	STBY	QOFF	
6	R-DIVIDER	WRITE	0x05	R7	R6	R5	R4	R3	R2	R1	R0	
7	N-DIVIDER MSB	WRITE	0x06	N12	N11	N10	N9	N8	N7	N6	N5	
8	N-DIVIDER LSB	WRITE	0x07	N4	N3	N2	N1	N0	X	X	X	
9	STATUS BYTE-1	READ	—	X	X	X	CP1	CP0	PWR	VASA	VASE	
10	STATUS BYTE-2	READ	—	VCO1	VCO0	VSB2	VSB1	VSB0	ADC2	ADC1	ADC0	

**Table 2. Test Register**

BIT NAME	BIT LOCATION (0 = LSB)	RECOMMENDED DEFAULT	FUNCTION
TUN[2:0]	7, 6, 5	000	Set the baseband bandpass filter center frequency. This filter's center frequency is trimmed at the factory, but may be manually adjusted by clearing the FLTS bit and programming the TUN[2:0] bits as follows: 000 = 0.75 x f <sub>0</sub> 001 = 0.80 x f <sub>0</sub> 010 = 0.86 x f <sub>0</sub> 011 = 0.92 x f <sub>0</sub> 100 = f <sub>0</sub> (nominal center frequency of 571kHz) 101 = 1.08 x f <sub>0</sub> 110 = 1.19 x f <sub>0</sub> 111 = 1.32 x f <sub>0</sub>
FLTS	4	1	Selects which registers set the baseband bandpass filter center frequency. 1 = selects internal factory-set register 0 = selects manual trim register TUN[2:0]

## ISDB-T Single-Segment Low-IF Tuners

**Table 2. Test Register (continued)**

BIT NAME	BIT LOCATION (0 = LSB)	RECOMMENDED DEFAULT	FUNCTION
MXSD	3	0	Used for factory trimming of the baseband filters. 1 = disables the quadrature mixers for filter tuning 0 = enables the quadrature mixers
D[2:0]	2, 1, 0	000	Control diagnostic features as follows: 000 = normal operation 001 = force charge-pump source current 010 = force charge-pump sink current 011 = force charge-pump high-impedance state 100 = power-detector RMS voltage at PWRDET 101 = N-divider output at TEST pin 110 = R-divider output at TEST pin 111 = local oscillator output at TEST pin

**Table 3. PLL Register**

BIT NAME	BIT LOCATION (0 = LSB)	RECOMMENDED DEFAULT	FUNCTION
CP[1:0]	7, 6	11	Set the charge-pump current. 00 = $\pm 1.5\text{mA}$ 01 = $\pm 2\text{mA}$ 10 = $\pm 2.5\text{mA}$ 11 = $\pm 3\text{mA}$
CPS	5	1	Sets the charge-pump current selection mode between automatic and manual. 0 = charge-pump current is set manually through the CP[1:0] bits 1 = charge-pump current is automatically selected based on ADC read values in both VAS and manual VCO selection modes
EPB	4	1	Controls the charge-pump prebias function. 0 = disables the charge-pump prebias function 1 = enables the charge-pump prebias function
RPD	3	0	Sets the prebias on-time control from reference divider. 0 = 280ns 1 = 650ns
NPD	2	0	Sets the prebias on-time control from VCO/LO divider. 0 = 500ns 1 = 1000ns
TON	1	0	Sets the charge-pump on-time control. 0 = 2.5ns 1 = 5ns
VAS	0	1	Controls the VCO autoselect (VAS) function. 0 = disables the VCO autoselect function and allows manual VCO selection through the VCO[1:0] and VSB[2:0] bits 1 = enables the on-chip VCO autoselect state machine

# ISDB-T Single-Segment Low-IF Tuners

**Table 4. VCO Register**

BIT NAME	BIT LOCATION (0 = LSB)	RECOMMENDED DEFAULT	FUNCTION
VCO[1:0]	7, 6	11	Control which VCO is activated when using manual VCO programming mode. This will also serve as the starting point for the VCO autoselect mode. 00 = select VCO 0 01 = select VCO 1 10 = select VCO 2 11 = select VCO 3
VSB[2:0]	5, 4, 3	011	Select a particular sub-band for each of the on-chip VCOs. Together with the VCO[2:0] bits a manual selection of a VCO and a sub-band can be made. This will also serve as the starting point for the VCO autoselect mode. 000 = select sub-band 0 001 = select sub-band 1 010 = select sub-band 2 011 = select sub-band 3 100 = select sub-band 4 101 = select sub-band 5 110 = select sub-band 6 111 = select sub-band 7
ADL	2	0	Enables or disables the VCO tuning voltage ADC latch when the VCO autoselect mode (VAS) is disabled. 0 = disables the ADC latch 1 = latches the ADC value
ADE	1	0	Enables or disables VCO tuning voltage ADC read when the VCO autoselect mode (VAS) is disabled. 0 = disables ADC read 1 = enables ADC read
LTC	0	0	Sets the source current for the VAS time constant. 0 = 1 $\mu$ A 1 = 2 $\mu$ A

# ISDB-T Single-Segment Low-IF Tuners

MAX2160/MAX2160EBG

Table 5. Control Register

BIT NAME	BIT LOCATION (0 = LSB)	RECOMMENDED DEFAULT	FUNCTION
MOD	7	0	Sets the modulation mode and the baseband gain step. 0 = selects QAM mode and disables the 7dB gain step 1 = selects QPSK mode and adds 7dB of gain in the baseband stages
BBL[1:0]	6, 5	10	Set the bias current for the baseband circuits to provide for fine linearity adjustments. 00 = lower linearity 01 = nominal linearity 10 = medium linearity 11 = high linearity
HSL5	4	1	Selects between high-side and low-side LO injection. 0 = low-side injection 1 = high-side injection
PD[2:0]	3, 2, 1	011	Set the AGC attack point (at RFIN). 000 = -62dBm 001 = -60dBm 010 = -58dBm 011 = -56dBm 100 = -54dBm 101 = -52dBm 110 = -50dBm 111 = -48dBm
EPD	0	0	Enables or disables the power-detector circuit. 0 = disables the power-detector circuit for low-current mode 1 = enables the power-detector circuit

# ISDB-T Single-Segment Low-IF Tuners

**Table 6. XTAL Divide**

BIT NAME	BIT LOCATION (0 = LSB)	RECOMMENDED DEFAULT	FUNCTION
XD[4:0]	7-3	00001	Set the crystal divider ratio for XTALOUT. 00000 = XTALOUT buffer disabled (off) 00001 = divide-by-1 00010 = divide-by-2 00011 = divide-by-3 00100 = divide-by-4 00101 through 11110 = all divide values from 3 (00101) to 30 (11110) 11111 = divide-by-31
PWDN	2	0	Software power-down control. 0 = normal operation 1 = shuts down the entire chip but leaves the 2-wire bus active and maintains the current register states
STBY	1	0	Software standby control. 0 = normal operation 1 = disables the signal path and frequency synthesizer leaving only the 2-wire bus, crystal oscillator, XTALOUT buffer, and XTALOUT buffer divider active
QOFF	0	0	Enables and disables the Q-channel output. 0 = Q channel enabled 1 = Q channel disabled

**Table 7. R-Divider Register**

BIT NAME	BIT LOCATION (0 = LSB)	RECOMMENDED DEFAULT	FUNCTION
R[7:0]	7-0	0x38	Set the PLL reference-divider (R) number. Default R-divider value is 56 decimal. R can range from 22 to 182 decimal.

**Table 8. N-Divider MSB Register**

BIT NAME	BIT LOCATION (0 = LSB)	RECOMMENDED DEFAULT	FUNCTION
N[12:5]	7-0	0x53	Set the most significant bits of the PLL integer-divider number (N). Default integer-divider value is N = 2687 decimal. N can range from 829 to 5374.

**Table 9. N-Divider LSB Register**

BIT NAME	BIT LOCATION (0 = LSB)	RECOMMENDED DEFAULT	FUNCTION
N[4:0]	7-3	11111	Set the least significant bits of the PLL integer-divider number (N). Default integer-divider value is N = 2687 decimal. N can range from 829 to 5374.
X	2, 1, 0	X	Unused.

# ISDB-T Single-Segment Low-IF Tuners

**Table 10. Status Byte-1 Register**

BIT NAME	BIT LOCATION (0 = LSB)	FUNCTION
X	7, 6, 5	Unused.
CP[1:0]	4, 3	Reflect the charge-pump current setting. See Table 3 for CP[1:0] definition.
PWR	2	Logic-high indicates power has been cycled, but the device has the default programming. A STOP condition while in read mode resets this bit.
VASA	1	Indicates whether VCO automatic selection was successful. 0 = indicates the autoselect function is disabled or unsuccessful VCO selection 1 = indicates successful VCO automatic selection
VASE	0	Status indicator for the autoselect function. 0 = indicates the autoselect function is active 1 = indicates the autoselect process is inactive

**Table 11. Status Byte-2 Register**

BIT NAME	BIT LOCATION (0 = LSB)	FUNCTION
VCO[1:0]	7, 6	Indicate which VCO has been selected by either the autoselect state machine or by manual selection when the VAS state machine is disabled. See Table 4 for VCO[1:0] definition.
VS[2:0]	5, 4, 3	Indicate which sub-band of a particular VCO has been selected by either the autoselect state machine or by manual selection when the VAS state machine is disabled. See Table 4 for VS[2:0] definition.
ADC[2:0]	2, 1, 0	Indicate the 3-bit ADC conversion of the VCO tuning voltage (VTUNE).

## 2-Wire Serial Interface

The MAX2160/EBG uses a 2-wire I<sup>2</sup>C-compatible serial interface consisting of a serial-data line (SDA) and a serial-clock line (SCL). SDA and SCL facilitate bidirectional communication between the MAX2160/EBG and the master at clock frequencies up to 400kHz. The master initiates a data transfer on the bus and generates the SCL signal to permit data transfer. The MAX2160/EBG behave as a slave device that transfers and receives data to and from the master. SDA and SCL must be pulled high with external pullup resistors (1kΩ or greater) for proper bus operation.

One bit is transferred during each SCL clock cycle. A minimum of nine clock cycles is required to transfer a byte in or out of the MAX2160/EBG (8 bits and an ACK/NACK). The data on SDA must remain stable during the high period of the SCL clock pulse. Changes in SDA while SCL is high and stable are considered con-

trol signals (see the *START and STOP Conditions* section). Both SDA and SCL remain high when the bus is not busy.

### START and STOP Conditions

The master initiates a transmission with a START condition (S), which is a high-to-low transition on SDA while SCL is high. The master terminates a transmission with a STOP condition (P), which is a low-to-high transition on SDA while SCL is high.

### Acknowledge and Not-Acknowledge Conditions

Data transfers are framed with an acknowledge bit (ACK) or a not-acknowledge bit (NACK). Both the master and the MAX2160/EBG (slave) generate acknowledge bits. To generate an acknowledge, the receiving device must pull SDA low before the rising edge of the acknowledge-related clock pulse (ninth pulse) and keep it low during the high period of the clock pulse.



# ISDB-T Single-Segment Low-IF Tuners

To generate a not-acknowledge condition, the receiver allows SDA to be pulled high before the rising edge of the acknowledge-related clock pulse, and leaves SDA high during the high period of the clock pulse. Monitoring the acknowledge bits allows for detection of unsuccessful data transfers. An unsuccessful data transfer happens if a receiving device is busy or if a system fault has occurred. In the event of an unsuccessful data transfer, the bus master must reattempt communication at a later time.

### Slave Address

The MAX2160/EBG have a 7-bit slave address that must be sent to the device following a START condition to initiate communication. The slave address is internally programmed to 1100000. The eighth bit (R/W) following the 7-bit address determines whether a read or write operation will occur.

The MAX2160/EBG continuously await a START condition followed by its slave address. When the device recognizes its slave address, it acknowledges by pulling the SDA line low for one clock period; it is ready to accept or send data depending on the R/W bit (Figure 1).

### Write Cycle

When addressed with a write command, the MAX2160/EBG allow the master to write to a single register or to multiple successive registers.

A write cycle begins with the bus master issuing a START condition followed by the seven slave address bits and a write bit (R/W = 0). The MAX2160/EBG issue an ACK if the slave address byte is successfully received. The bus master must then send to the slave the address of the first register it wishes to write to (see Table 1 for register addresses). If the slave acknowledges the address, the master can then write one byte to the register at the specified address. Data is written beginning with the most significant bit. The MAX2160/EBG again issue an ACK if the data is successfully written to the register. The master can continue to write data to the successive internal registers with the MAX2160/EBG acknowledging each successful transfer, or it can terminate transmission by issuing a STOP condition. The write cycle will not terminate until the master issues a STOP condition.

Figure 2 illustrates an example in which registers 0 through 2 are written with 0x0E, 0xD8, and 0xE1, respectively.

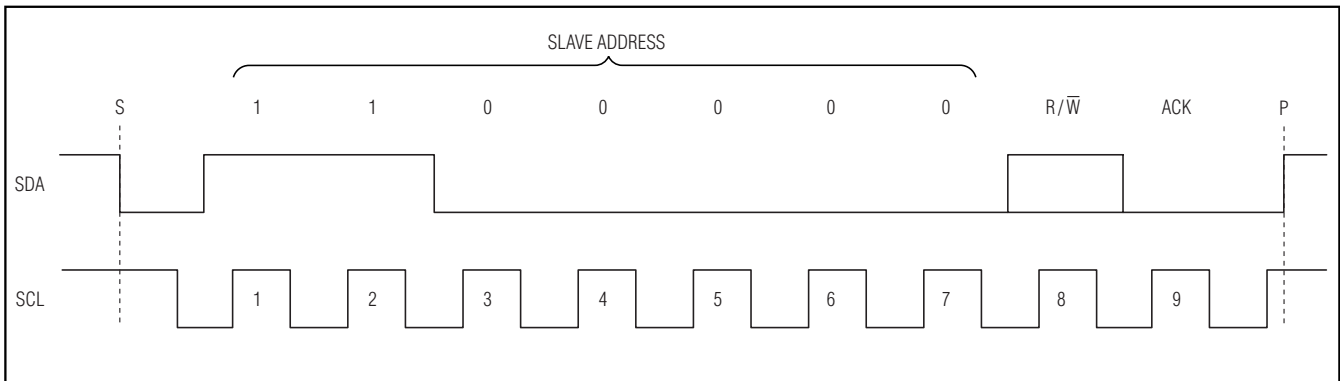

Figure 1. MAX2160 Slave Address Byte

START	WRITE DEVICE ADDRESS	R/W	ACK	WRITE REGISTER ADDRESS	ACK	WRITE DATA TO REGISTER 0x00	ACK	WRITE DATA TO REGISTER 0x01	ACK	WRITE DATA TO REGISTER 0x02	ACK	STOP
	1100000	0		0x00		0x0E		0xD8		0xE1		

Figure 2. Example: Write Registers 0 through 2 with 0x0E, 0xD8, and 0xE1, Respectively

# ISDB-T Single-Segment Low-IF Tuners

START	WRITE DEVICE ADDRESS	R/W	ACK	READ FROM STATUS BYTE-1 REGISTER	ACK	READ FROM STATUS BYTE-2 REGISTER	ACK/NACK	STOP
	1100000	1						

Figure 3. Example: Receive Data from Read Registers

### Read Cycle

There are only two registers on the MAX2160/EBG that are available to be read by the master. When addressed with a read command, the MAX2160/EBG send back the contents of both read registers (STATUS BYTE-1 and STATUS BYTE-2).

A read cycle begins with the bus master issuing a START condition followed by the seven slave address bits and a read bit ( $R/\bar{W} = 1$ ). If the slave address byte is successfully received, the MAX2160/EBG issue an ACK. The master then reads the contents of the STATUS BYTE-1 register, beginning with the most significant bit, and acknowledges if the byte is received successfully. Next, the master reads the contents of the STATUS BYTE-2 register. At this point the master can issue an ACK or NACK and then a STOP condition to terminate the read cycle.

Figure 3 illustrates an example in which the read registers are read by the master.

## Applications Information

### RF Input (RFIN)

The MAX2160/EBG are internally matched to  $50\Omega$  and requires a DC-blocking capacitor (see the *Typical Operating Circuit*).

### RF Gain Control (GC1)

The MAX2160/EBG feature a variable-gain low-noise amplifier that provides 43dB of RF gain-control range. The voltage control ( $V_{GC1}$ ) range is 0.3V (minimum attenuation) to 2.7V (maximum attenuation).

### IF Power Detector

The MAX2160/EBG include a true RMS power detector at the mixer output. The power-detector circuit is enabled or disabled with the EPD bit in the control register. The attack point can be set through the PD[2:0]

bits in the control register (see Table 5 for a summary of attack point settings).

The PWRDET pin output can be configured to provide either a voltage output (directly from the RMS power-detector stage) or current output (default) through the diagnostic bits D[2:0] in the test register.

### Closed-Loop RF Power Control

The default mode of the IF power detector is current output mode. Closed-loop RF power control is formed by connecting the PWRDET pin directly to the GC1 pin. A shunt capacitor to ground is added to set the closed-loop response time (see the *Typical Operating Circuit*). The recommended capacitor value of 10nF provides a response time of 0.1ms.

Closed-loop RF power control can also be formed using the baseband processor and the power detector in voltage output mode. In this configuration, the processor senses the power detector's output voltage and uses this information to drive the GC1 pin directly. Voltage output mode is enabled by setting the D[2:0] bits in the test register to 100. In voltage mode, the PWRDET pin outputs a scaled DC voltage proportional to the RF input power. For the RF input range of -62dBm to -48dBm, the DC output voltage ranges from 84mV to 420mV.

### High-Side and Low-Side LO Injection

The MAX2160/EBG allow selection between high-side and low-side LO injection through the HSLS bit in the control register. High-side injection is the default setting (HSLS = 1).

### Q-Channel Shutdown

The Q channel low-IF output of the MAX2160/EBG can be turned off with the QOFF bit in the XTAL divide register for use with single low-IF input demodulators (use I channel only). Turning off the Q channel reduces the supply current by approximately 3mA.

# ISDB-T Single-Segment Low-IF Tuners

## IF Filter Tuning

The center frequency of the baseband bandpass filter is tuned to 571kHz during production at the factory. However, the factory-set trim may be bypassed and the filter's center frequency can be adjusted through the FLTS and TUN[2:0] bits in the test register. Setting the FLTS bit sets the filter's center frequency to the factory-set tuning, clearing the FLTS bit allows the filter's center frequency to be adjusted with the TUN[2:0] bits (see Table 2).

## Fixed IF Gain Step

To maintain the best possible sensitivity for both QPSK and QAM signals, the MAX2160/EBG include a control bit (MOD) to increase the gain of the baseband stage by approximately 7dB. This gain step is intended to be used when receiving QPSK signals. Set the MOD bit to one in QPSK receive mode, set the MOD bit to zero in QAM receive mode.

## VCO Autoselect (VAS)

The MAX2160/EBG include four VCOs with each VCO having eight sub-bands. The local oscillator frequency can be manually selected by programming the VCO[1:0] and VSB[2:0] bits in the VCO register. The selected VCO and sub-band is reported in the STATUS BYTE-2 register (see Table 11).

Alternatively, the MAX2160/EBG can be set to automatically choose a VCO and VCO sub-band. Automatic VCO selection is enabled by setting the VAS bit in the PLL register, and is initiated once the N-divider LSB register word is loaded. In the event that only the R-divider register or N-divider MSB register word is changed, the N-divider LSB word must also be loaded (last) to initiate the VCO autoselect function. The VCO and VCO sub-band that are programmed in the VCO[1:0] and VSB[2:0] bits serve as the starting point for the automatic VCO selection process.

**Table 12. Charge-Pump Current Selection**

VAS	CPS	VASA	CHARGE-PUMP VALUES (CP[1:0])
0	0	X	Values programmed with 2-wire bus
0	1	X	Values selected by ADC read
1	0	X	Values programmed with 2-wire bus
1	1	0	Values programmed with 2-wire bus
1	1	1	Values selected by ADC read

During the selection process, the VASE bit in the STATUS BYTE-2 register is cleared to indicate the automatic selection function is active. Upon successful completion, bits VASE and VASA are set and the VCO and sub-band selected are reported in the STATUS BYTE-2 register (see Table 11). If the search is unsuccessful, VASA is cleared and VASE is set. This indicates that searching has ended but no good VCO has been found, and occurs when trying to tune to a frequency outside the VCO's specified frequency range.

## Charge-Pump Select (CPS)

The MAX2160/EBG also allow for manual selection of the charge-pump current (CPS = 0) or automatic selection based on the final VTUNE ADC read value (CPS = 1). When in manual mode, the charge-pump current is programmed by bits CP[1:0] with the 2-wire bus. When in automatic selection mode, the CP[1:0] bits are automatically set according to the ADC table (see Tables 12 and 13). The selected charge-pump current (manually or automatically) is reported in the STATUS BYTE-1 register.

## 3-Bit ADC

The MAX2160/EBG have an internal 3-bit ADC connected to the VCO tune pin (VTUNE). This ADC can be used for checking the lock status of the VCOs.

Table 13 summarizes the ADC trip points, associated charge-pump settings (when CPS = 1), and the VCO lock indication. The VCO autoselect routine will only select a VCO in the "VAS locked" range. This allows room for a VCO to drift over temperature and remain in a valid "locked" range.

The ADC must first be enabled by setting the ADE bit in the VCO register. The ADC reading is latched by a subsequent programming of the ADC latch bit (ADL = 1). The ADC value is reported in the STATUS BYTE-2 register (see Table 11).

**Table 13. ADC Trip Points, Associated Charge-Pump Settings, and Lock Status**

VTUNE (VT)	ADC[2:0]	CP[1:0]	LOCK STATUS
$V_T < 0.41V$	000	00	Out of Lock
$0.41V < V_T < 0.6V$	001	00	Locked
$0.6V < V_T < 0.9V$	010	00	VAS Locked
$0.9V < V_T < 1.3V$	011	01	VAS Locked
$1.3V < V_T < 1.7V$	100	10	VAS Locked
$1.7V < V_T < 1.9V$	101	11	VAS Locked
$1.9V < V_T < V_{CC} - 0.41V$	011	11	Locked
$V_{CC} - 0.41V < V_T$	111	11	Out of Lock

# ISDB-T Single-Segment Low-IF Tuners

## Loop Time Constant Pin (LTC)

The LTC function sets the wait time for an ADC read when in VCO autoselect mode. The time constant is set by charging an external capacitor connected to the LTC pin with a constant current source. The value of the current source can be programmed to 1 $\mu$ A or 2 $\mu$ A with the LTC bit in the VCO register (see Table 4).

The LTC time constant is determined by the following equation:

$$\text{Time constant} = C_{LTC} \times 1.7 / I_{LTC}$$

where:

$C_{LTC}$  = capacitor connected from the LTC pin to ground.

$I_{LTC}$  = 1 $\mu$ A (LTC = 0) or 2 $\mu$ A (LTC = 1).

Setting  $C_{LTC}$  equal to 1000pF gives a time constant of 1.7ms with  $I_{LTC}$  set to 1 $\mu$ A and 0.85ms with  $I_{LTC}$  set to 2 $\mu$ A.

## ENTCXO

The MAX2160/EBG have both an integrated crystal oscillator and a separate TCXO buffer amplifier. The ENTCXO pin controls which reference source is used (see Table 14).

## XTALOUT Divider

A reference buffer/divider is provided for driving external devices. The divider can be set for any division ratio from 1 to 31 by programming the XD[4:0] bits in the XTAL divide register (see Table 6). The buffer can be disabled by setting XD[4:0] to all zeros.

**Table 14. Reference Source Selection**

ENTCXO	FUNCTION
V <sub>CC</sub>	The TCXO input is enabled for use with an external TCXO
GND	The XTAL input is enabled for use with an external crystal

**Table 15. Power-Down Modes**

MODE	POWER-DOWN CONTROL			CIRCUIT STATES			DESCRIPTION
	$\overline{\text{SHDN}}$ PIN	PWDN BIT	STBY BIT	SIGNAL PATH	2-WIRE INTERFACE	XTAL	
Normal	V <sub>CC</sub>	0	0	ON	ON	ON	All circuits active
Shutdown	GND	X	X	OFF	OFF	OFF	All circuits disabled
Power-Down	V <sub>CC</sub>	1	0	OFF	ON	OFF	2-wire interface is active
Standby	V <sub>CC</sub>	0	1	OFF	ON	ON	2-wire interface, XTAL, and XTAL buffer/divider are active

## Shutdown and Standby Modes

The MAX2160/EBG feature hardware- and software-controlled shutdown mode as well as a software-controlled standby mode. Driving the  $\overline{\text{SHDN}}$  pin low with bit EPD = 0 places the device in hardware shutdown mode. In this mode, the entire device including the 2-wire-compatible interface is turned off and the supply current drops to less than 10 $\mu$ A. The hardware shutdown pin overrides the software shutdown and standby modes.

Setting the PWDN bit in the XTAL divide register enables power-down mode. In this mode, all circuitry except for the 2-wire-compatible bus is disabled, allowing for programming of the MAX2160/EBGs' registers while in shutdown. Setting the STBY bit in the XTAL divide register puts the device into standby mode, during which only the 2-wire-compatible bus, the crystal oscillator, the XTAL buffer, and the XTAL buffer/divider are active.

In all cases, register settings loaded prior to entering shutdown are saved upon transition back to active mode. Default register values are loaded only when V<sub>CC</sub> is applied from a no-V<sub>CC</sub> state. The various power-down modes are summarized in Table 15. Supply current fluctuations for nondefault register settings are shown in Table 16.

## Diagnostic Modes and Test Pin

The MAX2160/EBG have several diagnostic modes that are controlled by the D[2:0] bits in the test register (see Table 2). The local oscillator can be directed to the TEST pin for LO measurements by setting the D[2:0] bits to all ones. In this mode, the supply current will increase by approximately 10mA. The TEST pin requires a 10k $\Omega$  pullup resistor to V<sub>CC</sub> for proper operation.

# ISDB-T Single-Segment Low-IF Tuners

MAX2160/MAX2160EBG

**Table 16. Typical Supply Current Fluctuations for Nondefault Register Settings**

MODE	BIT CHANGE	TYPICAL I <sub>CC</sub>	TYPICAL ΔI <sub>CC</sub> FROM NOMINAL
Receive	Default register settings	46.5mA	—
	QOFF = 1 (Q channel off)	—	-3.3mA
	BBL[1:0] = 00 (lower linearity)	—	-2mA
	BBL[1:0] = 01 (nominal linearity)	—	-1mA
	BBL[1:0] = 11 (high linearity)	—	+1mA
	MOD = 1 (7dB baseband gain step enabled)	—	+0.3mA
	EPD = 1 (power detector enabled)	—	+1mA
	EPB = 0 (charge-pump prebias disabled)	—	+5.1mA
	XD[4:0] = 00000 (XTALOUT buffer disabled)	—	-40μA
Shutdown	$\overline{\text{SHDN}} = \text{GND}$	1μA	—
Standby	STBY = 1	2.2mA	—
Power-Down	PWDN = 1	13.5μA	—

### Layout Considerations

The EV kit serves as a guide for PC board layout. Keep RF signal lines as short as possible to minimize losses and radiation. Use controlled impedance on all high-frequency traces. For proper operation of the TQFN package, the exposed paddle must be soldered evenly to the board's ground plane. Use abundant vias beneath the exposed paddle for maximum heat dissipation. Use abundant ground vias between RF traces to minimize undesired coupling. Bypass each V<sub>CC</sub> pin to ground with a 100pF capacitor placed as close to the pin as possible.

In addition, the ground returns for the VCO, VTUNE, and charge pump require special layout consideration.

The VCOBYP capacitor (C37) and the VCCVCO bypass capacitor (C19) ground returns must be routed back to the GNDVCO pin and then connected to the overall ground plane at that point (GNDVCO). All loop filter component grounds (C27–C30) and the VCCCP bypass capacitor (C17) ground must all be routed together back to the GNDCP pin. GNDTUNE must also be routed back to the GNDCP pin along with all other grounds from the PLL loop filter. The GNDCP pin must then be connected to the overall ground plane. Figure 4 shows a schematic drawing of the required layout connections. Refer to the MAX2160 evaluation kit for a recommended board layout.

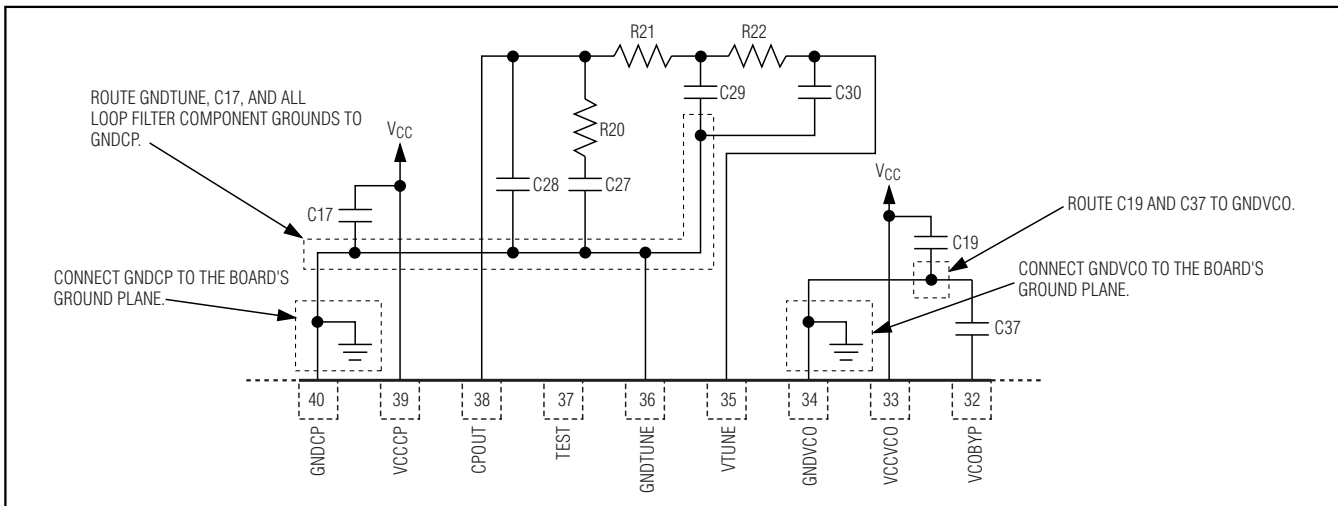
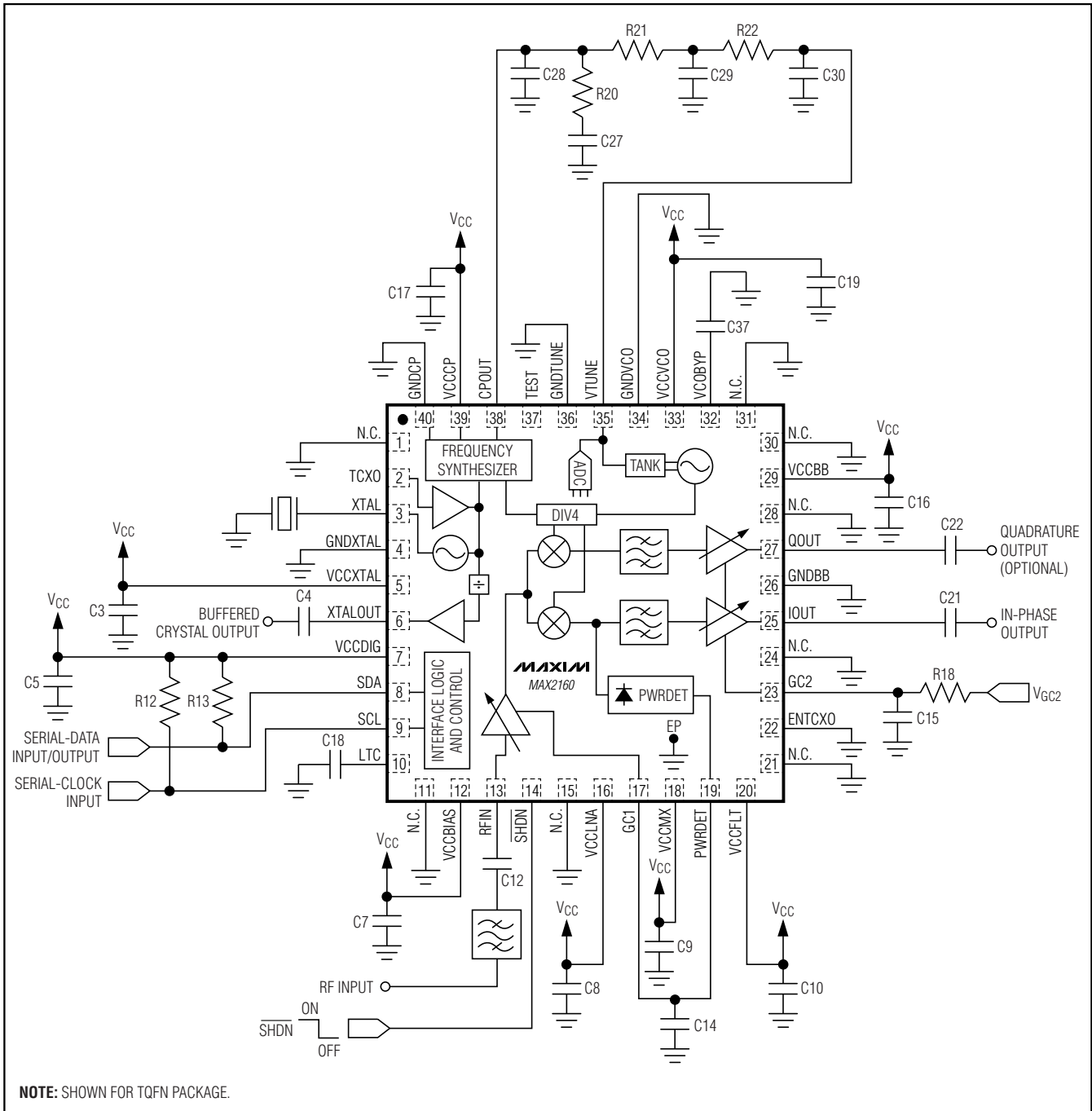

Figure 4. Ground Return Layout Connections for the VCO, Charge Pump, and VTUNE

# ISDB-T Single-Segment Low-IF Tuners

**MAX2160/MAX2160EBG**

## Typical Operating Circuit



### Chip Information

TRANSISTOR COUNT: 23,510

PROCESS: BiCMOS

# ISDB-T Single-Segment Low-IF Tuners

## Pin Configurations/Functional Diagrams (continued)

**MAX2160/MAX2160EBG**

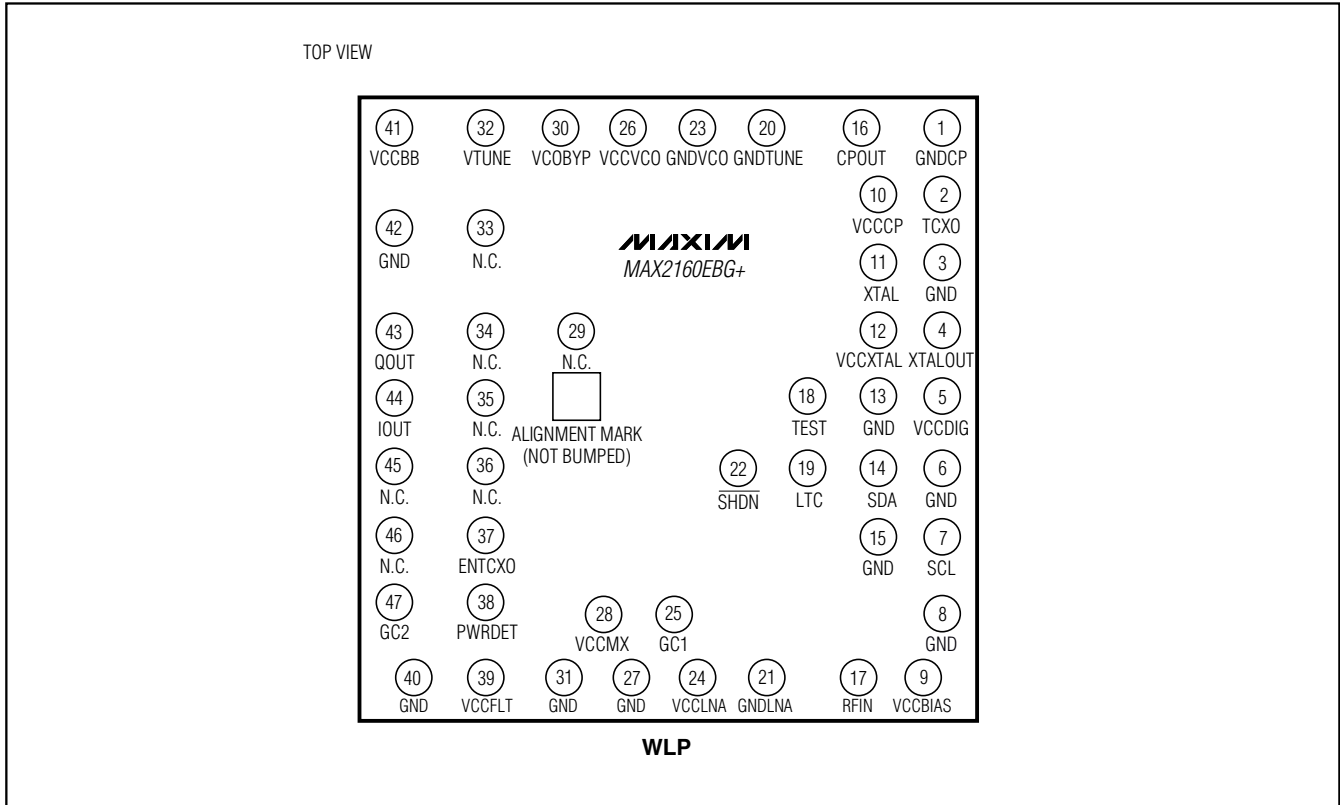





# ISDB-T Single-Segment Low-IF Tuners

## Package Information (continued)

(The package drawing(s) in this data sheet may not reflect the most current specifications. For the latest package outline information go to [www.maxim-ic.com/packages](http://www.maxim-ic.com/packages).)

MAX2160/MAX2160EBG

COMMON DIMENSIONS									
PKG. SYMBOL	36L 6x6			40L 6x6			48L 6x6		
	MIN.	NOM.	MAX.	MIN.	NOM.	MAX.	MIN.	NOM.	MAX.
A	0.70	0.75	0.80	0.70	0.75	0.80	0.70	0.75	0.80
A1	0	0.02	0.05	0	0.02	0.05	0	—	0.05
A2	0.20 REF.			0.20 REF.			0.20 REF.		
b	0.20	0.25	0.30	0.20	0.25	0.30	0.15	0.20	0.25
D	5.90	6.00	6.10	5.90	6.00	6.10	5.80	6.00	6.10
E	5.90	6.00	6.10	5.90	6.00	6.10	5.80	6.00	6.10
e	0.50 BSC.			0.50 BSC.			0.40 BSC.		
k	0.25	—	—	0.25	—	—	0.25	0.35	0.45
L	0.45	0.55	0.65	0.30	0.40	0.50	0.40	0.50	0.60
L1	—	—	—	—	—	—	0.30	0.40	0.50
N	36			40			48		
ND	9			10			12		
NE	9			10			12		
JEDEC	WJJD-1			WJJD-2			—		

PKG. CODES	EXPOSED PAD VARIATIONS						DOWN BONDS ALLOWED
	D2			EZ			
	MIN.	NOM.	MAX.	MIN.	NOM.	MAX.	
T3666-2	3.60	3.70	3.80	3.60	3.70	3.80	YES
T3666-3	3.60	3.70	3.80	3.60	3.70	3.80	NO
T3666N-1	3.60	3.70	3.80	3.60	3.70	3.80	NO
T4066-2	4.00	4.10	4.20	4.00	4.10	4.20	YES
T4066-3	4.00	4.10	4.20	4.00	4.10	4.20	YES
T4066-4	4.00	4.10	4.20	4.00	4.10	4.20	NO
T4066-5	4.00	4.10	4.20	4.00	4.10	4.20	NO
T4866-1	4.20	4.30	4.40	4.20	4.30	4.40	YES

**NOTES:**

- DIMENSIONING & TOLERANCING CONFORM TO ASME Y14.5M-1994.
- ALL DIMENSIONS ARE IN MILLIMETERS. ANGLES ARE IN DEGREES.
- N IS THE TOTAL NUMBER OF TERMINALS.
- THE TERMINAL #1 IDENTIFIER AND TERMINAL NUMBERING CONVENTION SHALL CONFORM TO JESD 95-1 SPP-012. DETAILS OF TERMINAL #1 IDENTIFIER ARE OPTIONAL, BUT MUST BE LOCATED WITHIN THE ZONE INDICATED. THE TERMINAL #1 IDENTIFIER MAY BE EITHER A MOLD OR MARKED FEATURE.
- DIMENSION b APPLIES TO METALLIZED TERMINAL AND IS MEASURED BETWEEN 0.25 mm AND 0.30 mm FROM TERMINAL TIP.
- ND AND NE REFER TO THE NUMBER OF TERMINALS ON EACH D AND E SIDE RESPECTIVELY.
- DEPOPULATION IS POSSIBLE IN A SYMMETRICAL FASHION.
- COPLANARITY APPLIES TO THE EXPOSED HEAT SINK SLUG AS WELL AS THE TERMINALS.
- DRAWING CONFORMS TO JEDEC M0220, EXCEPT FOR 0.4mm LEAD PITCH PACKAGE T4866-1.
- WARPAGE SHALL NOT EXCEED 0.10 mm.
- MARKING IS FOR PACKAGE ORIENTATION REFERENCE ONLY.
- NUMBER OF LEADS SHOWN FOR REFERENCE ONLY.

 	
<small>PROPRIETARY INFORMATION</small>	
<small>TITLE: PACKAGE OUTLINE 36, 40, 48L THIN QFN, 6x6x0.8mm</small>	
<small>APPROVAL</small>	<small>DOCUMENT CONTROL NO. 21-0141</small>
<small>REV. F</small>	<small>2/2</small>

Maxim cannot assume responsibility for use of any circuitry other than circuitry entirely embodied in a Maxim product. No circuit patent licenses are implied. Maxim reserves the right to change the circuitry and specifications without notice at any time.

**Maxim Integrated Products, 120 San Gabriel Drive, Sunnyvale, CA 94086 408-737-7600** \_\_\_\_\_ 25