

### 1.0 Features

- RRC Filters for both Tx and Rx
- $\pi/4$  DQPSK Modulation
- 2x 13-Bit Resolution Sigma Delta D-A
- 2x 16-Bit Resolution Sigma Delta A-D
- 4 x10-Bit D-A and 4 Input 10-Bit A-D
- Transmit Output Power Control
- Low Power 3.0 - 5.5Volt Operation
- Effective Power down Modes

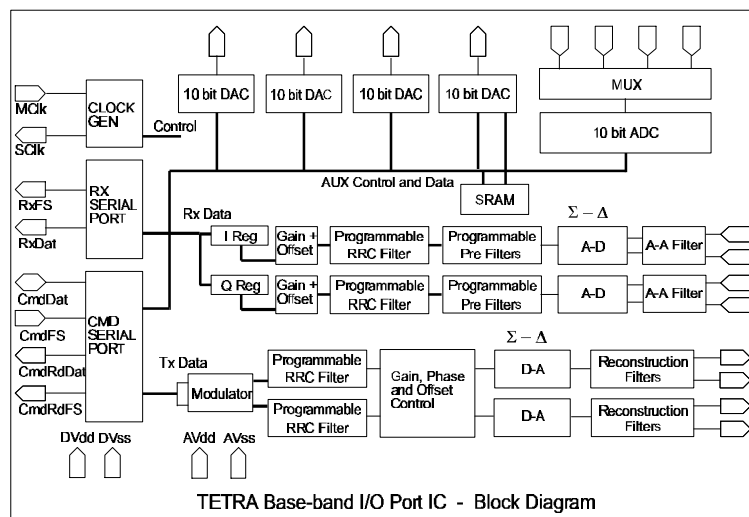

### 1.1 Brief Description

This device is intended to act as an interface between the analogue and digital sections of a Digital Radio System, and performs many critical and DSP-intensive functions. The chip is designed with the necessary capability to meet the requirements for use in both mobile and base station applications in Terrestrial Trunked Radio (TETRA) systems.

The transmit path comprises all the circuitry required to convert digital data into suitably filtered analogue I and Q signals for subsequent up-conversion and transmission. This includes digital control of the output amplitudes, digital control of the output offsets and fully programmable digital filters: default coefficients provide the RRC response required for TETRA.

The receive section accepts differential analogue I and Q signals at baseband and converts these into a suitably filtered digital form for further processing and data extraction. A facility is provided for digital offset correction and the digital filters are fully programmable with default coefficients providing the RRC response required for TETRA.

Auxiliary DAC and ADC functions are included for the control and measurement of the RF section of the radio system. This may include AFC, AGC, RSSI, or may be used as part of the control system for a Cartesian Loop.

## CONTENTS

<u>Section</u>	<u>Page</u>
<b>1.0 FEATURES</b> .....	<b>1</b>
<b>1.1 BRIEF DESCRIPTION</b> .....	<b>1</b>
<b>1.2 BLOCK DIAGRAM</b> .....	<b>3</b>
<b>1.3 SIGNAL LIST</b> .....	<b>4</b>
<b>1.4 EXTERNAL COMPONENTS</b> .....	<b>6</b>
<b>1.5 GENERAL DESCRIPTION</b> .....	<b>7</b>
<b>1.5.1 Connection and Decoupling of Power Supplies</b> .....	<b>7</b>
<b>1.5.2 Tx Data Path</b> .....	<b>8</b>
1.5.2.1 Modulator .....	8
1.5.2.2 Filters .....	8
1.5.2.3 Gain Multiplier .....	8
1.5.2.4 Offset Adjust .....	8
1.5.2.5 Sigma-Delta D-A Converters and Reconstruction Filters .....	8
1.5.2.6 Phase Pre-distortion .....	8
1.5.2.7 Ramping Output Amplitude .....	8
<b>1.5.3 Rx Data Path</b> .....	<b>9</b>
1.5.3.1 Anti-Alias Filtering and Sigma-Delta A-D Converters .....	9
1.5.3.2 Filters .....	9
1.5.3.3 Offset Registers .....	9
1.5.3.4 I and Q Channel Gain .....	9
<b>1.5.4 Auxiliary Circuits</b> .....	<b>9</b>
1.5.4.1 10-Bit DACs .....	9
1.5.4.2 10-Bit ADC .....	9
1.5.4.3 Power Ramping and Control .....	10
<b>1.5.5 IRQ Function</b> .....	<b>10</b>
<b>1.5.6 Serial Interface</b> .....	<b>10</b>
1.5.6.1 Command Interface .....	11
1.5.6.2 Command Read Interface .....	12
1.5.6.3 Rx Data Interface .....	12
1.5.6.4 Transmission of Data .....	12
1.5.6.5 Command Control Serial Word .....	13
<b>1.5.7 Register Description</b> .....	<b>14</b>
1.5.7.1 Register and Access Point Summary .....	16
<b>1.6 APPLICATION NOTES</b> .....	<b>33</b>
1.6.1 General .....	33
1.6.2 Transmitter .....	33
1.6.3 Receiver .....	33
1.6.4 Timing .....	33
<b>1.7 PERFORMANCE SPECIFICATION</b> .....	<b>33</b>
1.7.1 Electrical Performance .....	33
1.7.2 Packaging .....	33

**Note:** As this product is still in development, it is likely that a number of changes and additions will be made to this specification. Items marked TBD or left blank will be included in later issues. Information in this data sheet should not be relied upon for final product design.

### 1.2 Block Diagram

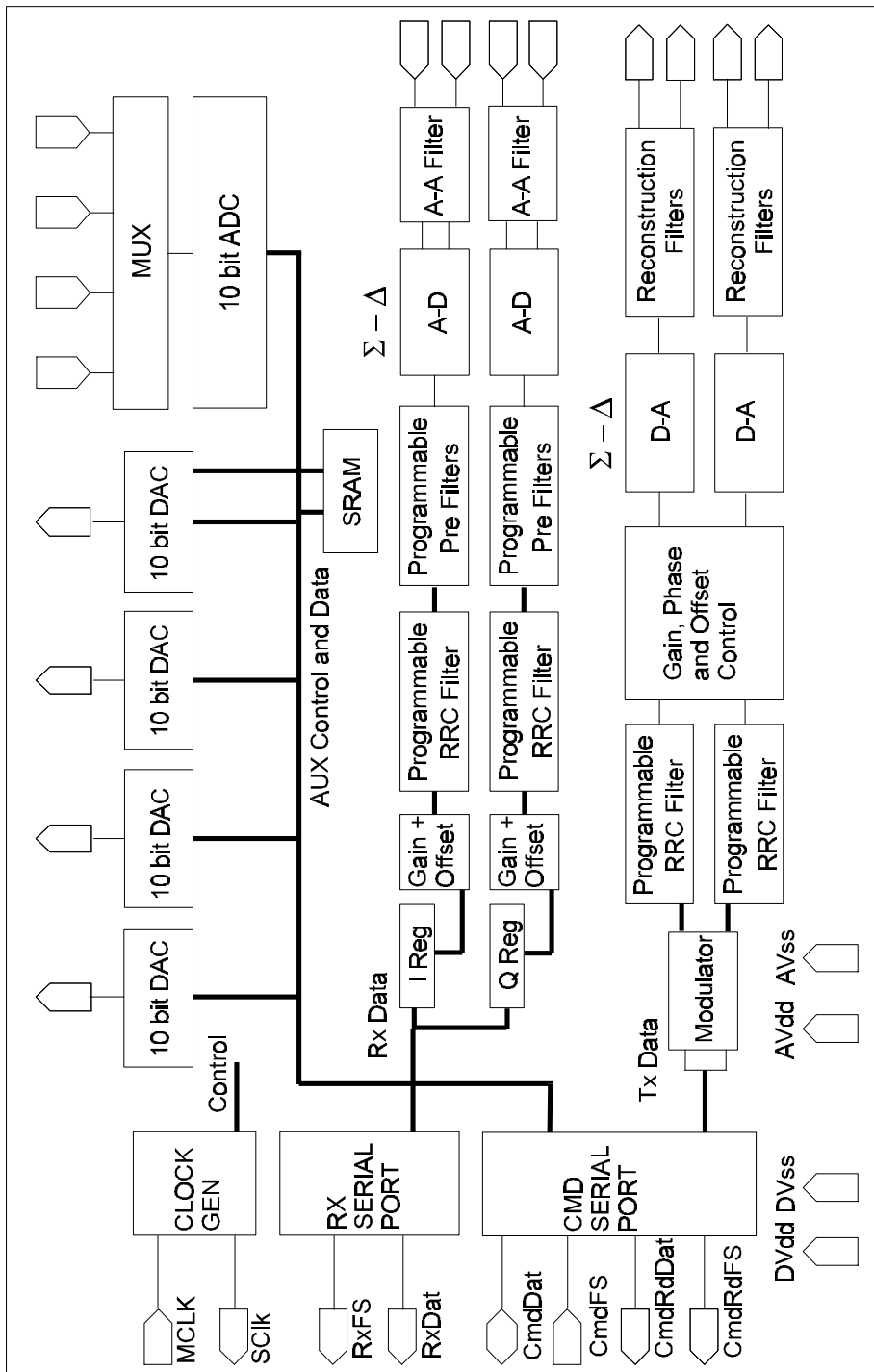

Figure 1 Block Diagram

### 1.3 Signal List

L6 Package 44 PLCC	Package #	Signal		Description		
		Pin No.	Pin No.		Name	Type
		15		MCLK	I/P	Master clock input (typically 9.216MHz)
		16		SClk	O/P	Serial interface clock
		17		CmdDat	BI	Command serial interface Data
		18		CmdFS	I/P	Command serial interface Frame
		19		CmdRdDat	O/P	Command serial interface Read Data
		20		CmdRdFS	O/P	Command serial interface Read Frame
		11		RxDat	O/P	Receive serial interface Data
		12		RxFS	O/P	Receive serial interface Strobe
		23		N_IRQ	O/P	Interrupt request
		14		N_RESET	I/P	Chip Reset
		24		SCANSEL	I/P	Scan Select (normally tied low)
		25		ITXP	O/P	Transmit "I" channel, positive output
		26		ITXN	O/P	Transmit "I" channel, negative output
		30		QTXP	O/P	Transmit "Q" channel, positive output
		29		QTXN	O/P	Transmit "Q" channel, negative output
		42		IRXP	I/P	Receive "I" channel, positive input
		41		IRXN	I/P	Receive "I" channel, negative input
		38		Q_RXP	I/P	Receive "Q" channel, positive input
		37		Q_RXN	I/P	Receive "Q" channel, negative input
		43		AUXADC1	I/P	Auxiliary ADC channel 1
		44		AUXADC2	I/P	Auxiliary ADC channel 2
		1		AUXADC3	I/P	Auxiliary ADC channel 3
		2		AUXADC4	I/P	Auxiliary ADC channel 4

### 1.3 Signal List (continued)

L6 Package 44 PLCC	Package #	Signal		Description
Pin No.	Pin No.	Name	Type	
10		AUXDAC1	O/P	Auxiliary DAC channel 1
9		AUXDAC2	O/P	Auxiliary DAC channel 2
8		AUXDAC3	O/P	Auxiliary DAC channel 3
7		AUXDAC4	O/P	Auxiliary DAC channel 4
36		BIAS1	BI	Analogue bias level. This pin should be de-coupled to $V_{SSB}$ .
35		BIAS2	BI	Analogue bias level. This pin should be de-coupled to $V_{SSB}$ .
32		$V_{CC1}$	Power	I Channel analogue positive supply rail. This pin should be de-coupled to $V_{SS1}$ .
33		$V_{CC2}$	Power	Q Channel analogue positive supply rail. This pin should be de-coupled to $V_{SS2}$ .
34		$V_{CC3}$	Power	Analogue Bias positive supply rail. Levels and voltages are dependent upon this supply. This pin should be de-coupled to $V_{SSB}$ .
6		$V_{DD1}$	Power	Auxiliary analogue positive supply rail. This pin should be de-coupled to $V_{SSA}$ .
3,21		$V_{DD}$	Power	Digital positive supply rail. This pin should be de-coupled to $V_{SS}$ .
27,40		$V_{SS1}$	Ground	I Channel analogue negative supply rail.
28,39		$V_{SS2}$	Ground	Q Channel analogue negative supply rail.
31		$V_{SSB}$	Ground	Analogue Bias negative supply rail.
5		$V_{SSA}$	Ground	Auxiliary analogue negative supply rail.
4,13,22		$V_{SS}$	Ground	Primary digital negative supply rail.

**Notes:** I/P = Input  
O/P = Output  
BI = Bi-directional

## 1.4 External Components

### Rx Inputs

When using the internal anti-alias filter, the following is suggested

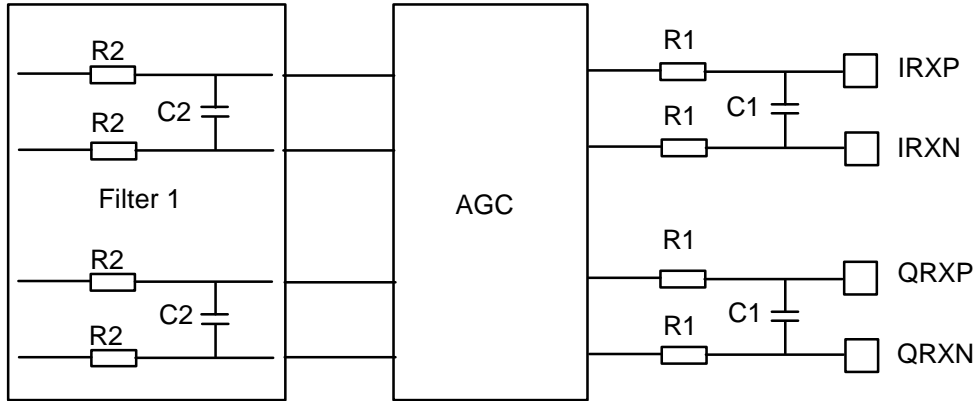

Example values:

- R1 = 220Ω                      C1 = 1.5nF (R1, C1 precise values are not critical) (-3dB at 240kHz)
- R2 = 408Ω                      C2 = 3.9nF (R2 x C2 time constant should be preserved) (-3dB at 50kHz)

When not using the internal anti alias filter, it is suggested that the user should follow the guidelines in Section 1.5.3.1. In both cases, there should be at least one filter pole close to the chip inputs.

**Figure 2a Recommended External Components - Rx Inputs**

### Tx Outputs

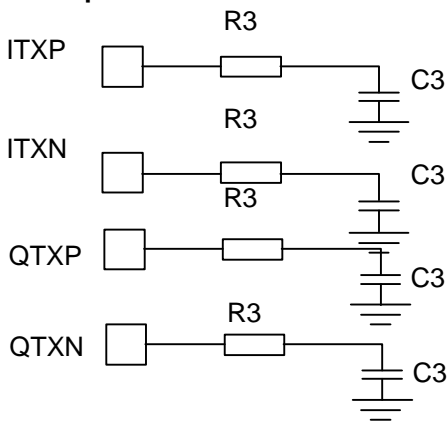

Example values:

- R3 = 220Ω                      C3 = 1nF

Decoupling capacitors should be employed as detailed in Section 1.5.1

**Figure 2b Recommended External Components - Tx Outputs**



## 1.5.2 Tx Data Path

The features described below give a high degree of flexibility for the user to compensate in the baseband processing for non-ideal performance in the IF, RF and RF linear amplifier sections.

### 1.5.2.1 Modulator

This takes the 2-bit symbols, performs a Gray code conversion and uses a recursive adder to generate a 3-bit code representing the 8 possible phase states. A look up table provides the digitally encoded I and Q values for each phase state. The modulator function can be by-passed if required; in this case the 3-bit code representing the 8 possible phase states which are passed to the look up table is provided directly via the serial interface.

### 1.5.2.2 Filters

Digital filtering is applied to the data from the modulator; the coefficients are set as default to give a Root Raised Cosine response with roll-off factor of 0.35. These FIR filters operate at 8x the incoming symbol rate and are configured, for each channel, as two filters in cascade: the first filter has 79 taps and the second filter has 49 taps. The first filter is used to enhance stop-band rejection and act as a sampling correction filter and the second filter provides the primary shaping. Coefficients for the filters may also be downloaded to the device via the serial interface; this gives the opportunity, if required, to fine tune the frequency response of a complete system so as to minimise the BER or to use the device in other applications. The filters can also be by-passed if required.

### 1.5.2.3 Gain Multiplier

This circuitry allows independent external control of the digital amplitudes in the I and Q channels to 12 bits of resolution. Extra circuits allow a mode of operation which will enable linear ramping up to a maximum value, stay at this value for a specified duration, then ramp back down to zero. The maximum value for each channel, the duration at maximum, the ramping up rate and the ramping down rate are all programmable via the serial interface.

### 1.5.2.4 Offset Adjust

Offset registers allow any offsets introduced in the analogue sections of the transmit path to be corrected digitally via the serial interface. The offset adjust has a resolution of 1 LSB and a maximum value of 0.25x full scale.

### 1.5.2.5 Sigma-Delta D-A Converters and Reconstruction Filters

The converters are designed to have low distortion and >80dB dynamic range. These 3rd order converters operate at a frequency of 128x symbol rate so as to over-sample the data at their inputs a further 16 times. The reconstruction filters are 5th order, switched capacitor, low pass filters designed to work in conjunction with an external RC.

### 1.5.2.6 Phase Pre-distortion

A further feature allows the user to compensate for a non-orthogonal carrier phase in the external quadrature modulator by adding a programmable fraction of up to 1/8 of the filtered I and Q channel signals to each other immediately prior to the DAC input.

### 1.5.2.7 Ramping Output Amplitude

A facility is provided to allow linear ramping of the outputs. This is accomplished, if enabled, by multiplying the gain multiplier words by the ramping control register (RCR) value. The RCR is a 12-bit word, representing a value from 0 to 1, which is designed to increment by an amount (INC) until its maximum value. This value is held until a number of symbol times from the start of transmission (TRD) when RCR decrements by an amount (DEC) until zero. INC, DEC and TRD are all 12-bit words input via the serial interface prior to the start of a transmission.



### 1.5.3 Rx Data Path

#### 1.5.3.1 Anti-Alias Filtering and Sigma-Delta A-D Converters

The sampling frequency of the Sigma-Delta A-D is 128x symbol rate. The high oversampling rate relaxes the design requirements on the anti-alias filter. However, to achieve optimum performance the anti-alias filter must reject the sampling frequency to about -110dB, of which at least 40dB must be provided externally. Additionally, in order to ease the complexity of the subsequent digital filters, there is a further requirement that the anti-alias filter suppress 8x symbol rate to about -30dB. The on-chip anti-alias filter is designed to achieve this when used in conjunction with some external filtering. If required, the on-chip anti-alias filter can be by-passed and powered down, although external anti-aliasing must then be provided. The 4th order Sigma-Delta A-D converters are designed to have low distortion and >96dB dynamic range. The baseband I and Q channels must be provided as differential signals; this minimises in-band pick up both on and off the chip.

#### 1.5.3.2 Filters

Digital filtering is applied to the data from the Sigma-Delta A-D converters; the default coefficients are set to give a Root Raised Cosine response with roll-off factor of 0.35. These FIR filters are configured, for each channel, as three filters in cascade. The first filter gives sufficient rejection at 8x symbol rate to permit decimation at that frequency (note that -30dB is provided by the primary anti-alias filters). The second filter has 63 taps and is used to enhance stop-band rejection. The third filter has 49 taps and provides the primary shaping requirements. Coefficients for the second and third filters are programmable via the serial interface. This gives the opportunity, if required, to fine tune the frequency response of a complete system so as to minimise the BER or to use the device in other applications. The filters can also be by-passed if required, by setting the centre coefficient to maximum and all other coefficients to zero.

#### 1.5.3.3 Offset Registers

System generated offsets may be removed by control of the offset register via the serial interface.

#### 1.5.3.4 I and Q Channel Gain

Programmable gain modules are provided in both I and Q channels. These blocks allow the user to adjust the dynamic range of the received data within the digital filters, thus optimising the filter signal to noise performance for a range of levels at the Rx input pins.

The two channels are independently programmable. This enables differential gain corrections to be made within the digital domain.

### 1.5.4 Auxiliary Circuits

#### 1.5.4.1 10-Bit DACs

Four 10-bit DACs are provided to assist in a variety of control functions. The DACs are designed to provide an output as a proportion of the supply voltage, depending on the digital input. They are monotonic with an absolute accuracy of better than 1%. Control and Data for these come via the serial interface.

#### 1.5.4.2 10-Bit ADC

A 10-bit ADC is provided to assist in a variety of measurement and control functions. The ADC is designed to produce a digital output proportional to the input voltage; full scale being the positive supply. It is monotonic with an absolute accuracy of about 1%. An input multiplexer allows the input to be selected from one of four sources. Control and digital data output is via the serial interface.

### 1.5.4.3 Power Ramping and Control

One of the DACs has an additional feature which enables a set of values to be sequenced out at a pre-selected frequency. This is aimed at enabling power ramping of a RF output with a suitable profile. The sequence may be reversed for power down. The sequence of values is stored in a dedicated RAM, which can be loaded via the serial interface.

### 1.5.5 IRQ Function

An interrupt request (IRQ) pin is provided for asynchronous communication with an external processor. The IRQ (asserted low) will be asserted when any of the error or user information flags are activated by an internal operation. Some examples of operations which may generate an IRQ are:

1. An attempt by the user to write to a full Tx data-input FIFO
2. An attempt is made by the Tx to read from the Tx data-input FIFO when it is empty.
3. An internal arithmetic overflow has occurred in an FIR filter.

The IRQ feature may also be used to establish the phasing of the received I and Q channel data from the RxDat serial port should synchronisation be lost for any reason.

The cause of the IRQ can be obtained by reading the error flags register. All possible causes of an IRQ are masked on reset. Mask status can be altered by writing to the IRQ mask register.

Note that default coefficients and settings have been optimised to maximise performance and should not cause arithmetic overflows. However, use of non-default coefficients, large offset corrections or large Tx phase adjustments may cause problems, which can be corrected by scaling down coefficients or via the gain multiplier feature.

### 1.5.6 Serial Interface

All digital data I/O and control functions for the FX980 are via the serial interface. It is expected that the FX980 will be used in conjunction with a DSP and/or other processor. The device has three serial interface ports, each port is based on the industrial standard three wire serial interface. This interface allows communication with standard DSP ICs using a minimum of external components. The three serial interface ports are:

- Cmd** Command port, generally this is an input port receiving commands and data from the host, but may also be configured as a bi-directional I/O interface.
- CmdRd** Command read port, an output port to send command read data back to the host. Read data is only sent on this port in response to a read command.
- RxData** Receive data port, an output port to send receive data back to the host. Data is only present on this interface when the Rx Data path is active. This port may also be configured as the *CmdRd* port.

Functions performed by the serial interface include:

- Power up or down and optional bypassing of selected blocks
- Setting digital filter coefficients
- Loading ramp up and ramp down increments and burst lengths for Tx
- Loading and transmitting data
- Loading offset correction, gain multiplier and phase adjustment registers
- Enabling/disabling of output via the Rx serial interface
- Vary sampling time for Rx data relative to the symbol (144kHz) clock.
- Loading data into auxiliary DACs
- Initiating conversions using auxiliary ADCs and reading results
- Writing data to, and reading data from, the Waveform Generation SRAM
- Power Ramping time step control

The three interfaces consist of the following signal pins:

SClk	Output	<i>Serial Clock</i> pin. This pin is common for all three interfaces.
CmdDat	In/Out	Command port <i>Data</i> pin. This pin is by default an input, but may be configured as an open drain bi-directional pin.
CmdFS	Input	Command port <i>Frame Sync</i> pin. This pin is used to mark the first bit in a serial frame.
CmdRdDat	Output	Command read port <i>Data</i> pin. This pin only has active data on it in response to a read command.
CmdRdFS	Output	Command read port <i>Frame Sync</i> pin. This pin is used to mark the first bit in a serial frame.
RxDat	Output	Receive data port <i>Data</i> pin. This pin is only active when the Rx Data path is active.
RxFS	Output	Receive data port <i>Frame Sync</i> pin. This pin is used to mark the first bit in a serial frame.

Note: All *Frame Sync* strobe signals are actually coincident with the last bit of a dataframe. See Figures 4 and 5 for further details.

**1.5.6.1 Command Interface**

A serial command word consists of a 16-bit frame. Each frame is marked by an active *Frame Sync* event which precedes the MSB bit. A command word can be either a control word or a transmit data word.

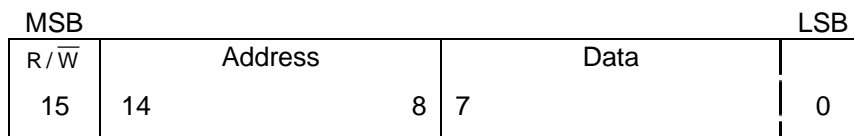

**Command Control Serial Word**

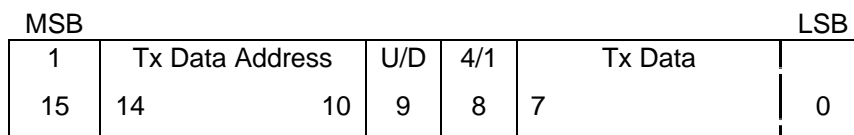

**Command Transmit Data Serial Word**

### 1.5.6.2 Command Read Interface

Command read data is either output on one of the serial read ports, or driven out in the last 8 bits (data field) on the *Cmd* port. When command read data is output on a serial read port, the read address is put in the most significant half of the word, and the read data in the least significant half.

MSB				LSB			
0	Read Address			Data			
15	14		8	7			0

**Command Read Serial Word**

### 1.5.6.3 Rx Data Interface

The Rx Data interface is used only for output of the I and Q received data, unless it is operating in the mode where *CmdRd* data is directed to it. When data reception is enabled, I and Q received data will be output at either 8x or 4x the symbol rate, under control of command register **RxSetup2**. (see Section 1.5.7). This is achieved by reducing the serial interface clock rate from MCLK/2 to MCLK/4 and discarding alternate data samples under control of command registers **ConfigCtrl1** and **RxSetup2**. 16-bit I and Q data words are output at the Rx Data interface, I data and MSB first (by default), on the rising edge of SClk.

### 1.5.6.4 Transmission of Data

The address of the Tx FIFO is given consecutive locations (\$0x04-\$0x07), which allows the address bits A1 and A0 (bits 11 and 10) of the Command Transmit Data Serial Word to be utilised as transmit control functions. Data to be transmitted can be in either one or four (2-bit) symbol blocks, which are subsequently modulated into the DQPSK constellation, or in 3-bit words, which map directly into constellation points according to the table shown below.

3 bit code	000	001	010	011	100	101	110	111
I	1	0.7071	0	-0.7071	-1	-0.7071	0	0.7071
Q	0	0.7071	1	0.7071	0	-0.7071	-1	-0.7071

**Constellation map**

The user initiates a transmit frame by asserting the *TxEn* bit in the **TxSetup** register. However, internal transmission of the data will wait until specific conditions have been met. Firstly, a valid data word must be written into the FIFO with the *TxRampEn* bit of the **TxSetup** register asserted. Secondly, the internal symbol clock must be active. Therefore there is a variable delay between asserting the *TxEn* bit and transmission starting. The user may poll the *TxPathEn* bit of the **TxFIFOStatus** register to establish when transmission has started, and in this case the active state of *TxPathEn* in High. In general, the user will wish to know when the transmit frame has completed. This is indicated by *TxPathEn* returning Low.

To relieve the user of polling overheads when waiting for Tx frame completion, an interrupt can be set up to occur on the transition of the *TxPathEn* bit from High to Low. In such circumstances, the interrupt activation state of the *TxPathEn* can be considered Low.

Two control bits are associated with each data transmission word. One controls the format of the word and the other initiates and terminates a transmission cycle. This close association enables precise control of the transmission frame. To relieve the user of the need to synchronise each **TxDData** write with the internal transmit cycle, transmit data words are written into an internal 4-word-deep FIFO. Symbols or constellation points are then read as needed from this FIFO. It is necessary to make sure that there is always a word to be read, and also that the FIFO is never written to when full. This may be accomplished by using one of two data interlock mechanisms.

#### Data Interlock Mechanisms

There are two possible transmission data interlock mechanisms. It is recommended that the user should always use one of these methods.

- Software polling.
- Serial Clock when ready.

*Software polling* requires the user to first check that the FIFO is not full before writing each **TxDData** word. This may be accomplished by inspecting the relevant FIFO status bits before writing one or more **TxDData** words.

The *Serial Clock when ready* method is a hardware interlock mechanism (enabled by setting the *TxHandshakeEn* bit of **ConfigCtrl1** register active). The mechanism allows the user to write **TxDData** words without doing any FIFO checks: the hardware handshake is implemented by stopping the serial port clock when the FIFO is full. To prevent a serial port lockout-condition, the handshake is only enabled once the transmission frame has been initiated and is automatically disabled at the end of a frame. This mechanism should be used with care, because stopping the clock will freeze all other serial port transfers (the serial port clock *SClk* is common to all three serial ports), including access to auxiliary data converters and receive data.

#### Power Ramping and Frame Interlock

The *RampUp* bit in the **TxDData** word is used to control both the power ramping function and the frame activation. To start a transmission frame, a transmission word is written with the *RampUp* bit active. All subsequent **TxDData** words prior to frame termination must also have this bit active. The frame is terminated by writing transmit data words with the *RampUp* bit inactive. Subsequent **TxDData** words must also have this bit inactive, until initiation of a new frame is required. While the power ramping is active (up or down) the user must supply transmission symbols or valid constellation points. Once the ramp down operation has completed, all subsequent **TxDData** writes with the *RampUp* bit inactive will be ignored.

### **1.5.6.5 Command Control Serial Word**

A command word either directly accesses an internal register for a read or write operation, or addresses a memory access point to indirectly access a block of internal memory. For test purposes all registers that can be written may also be read. Not all registers may be written, as some are just status registers. Each register or memory access point is assigned a unique address: the whole (8-bit) address range is reserved for the FX980.

#### Indirect Memory Addressing

All internal memory access is via an access point. First, a command word access is used to reset the internal address pointer, then data port access operations post-increment this address pointer.

Example: To program the fifth and sixth locations of the Auxiliary SRAM with \$0x01AA the commands would be:

```

$0x0000⇒Cmd    ; set ConfigCtrl1 all bits Low           ; use default conditions
$0x0118⇒Cmd    ; set ConfigCtrl2 bits 7 and 6 Low       ; required by default for these
                                     ; set ConfigCtrl2 bit 4 High           ; post-increment addresses on a
                                     ; set ConfigCtrl2 bit 3 High           ; enable read/write access to the
                                     ;                                     Auxiliary SRAM
$0xF300⇒Cmd    ; read SramData LSB register             ; read fourth memory location
                                     ;                                     (LSB). Post-increment pointer.
CmdRd⇒$0xF3xx  ; SramData LSB register data returned    ; discard this byte
$0x7002⇒Cmd    ; write SramData LSB register            ; write $0x02 to fifth memory
                                     ;                                     location (LSB)
$0x716A⇒Cmd    ; write SramData MSB register            ; write $0x6A to sixth memory
                                     ;                                     location (MSB)
$0xF000⇒Cmd    ; read SramData LSB register             ; read fifth memory location (LSB)
CmdRd⇒$0xF002  ; SramData LSB register data returned    ; check this byte is $0x02
$0xF100⇒Cmd    ; read SramData MSB register            ; read sixth memory location (MSB)
CmdRd⇒$0xF16A  ; SramData MSB register data returned    ; check this byte is $0x6A
$0x0110⇒Cmd    ; set ConfigCtrl2 bit 3 Low           ; disable read/write access to the
                                     ;                                     Auxiliary SRAM

```

### 1.5.6.6 Coefficient Memory

The convention for naming filter coefficients is A1 to An, where n is given by  $(\text{Filter Length} + 1)/2$ , i.e. for the 15-tap filter,  $n = 8$ . This arises from the internal architecture of the filters and the fact that they are all “odd” and symmetrical. Write or read operations beyond this coefficient number will be reflected about the central coefficient e.g. the tenth read operation from the 15-tap filter would access coefficient location A6.

There is no practical reason to write or read beyond location n, but the user in any case must avoid write operations at the  $(\text{Filter Length} + 1)$  location. This location (A0) location must be zero for the filters to operate correctly. The global reset (N-RESET pin) establishes this condition when taken Low.

### 1.5.7 Register Description

This section describes in detail each of the registers and access points addressed by the Command Control Serial Word.

### Key to Register Map

Each section that follows describes in detail the operation and use of each of the registers in the device. The registers are split into their functional groups, grouping associated registers together. Each section consists of a Title, an Address, a Function Reference Field, a Description, and a Bit Specification.

The Function Reference Field describes the overall access available to this section (RW/W/R, where R = Read and W = Write).

The Bit Specification describes the function of each individual bit, or a range of bits within a register. There is a separate line for each distinct field of bits. The State column indicates the action available to each group of bits (RW/W/R).

### Register Reset State

All I/O access points (both read and write) are reset to logic zero on taking N\_RESET Low, except where explicitly shown in this document. The reset state of status bits will depend on the level of the status signal being monitored. Other registers (both read and write) are not affected by taking N\_RESET Low.

### 1.5.7.1 Register and Access Point Summary

#### Control and Status Registers

\$0x00	<b>ConfigCtrl1</b>	Configuration control register 1
\$0x01	<b>ConfigCtrl2</b>	Configuration control register 2
\$0x02	<b>PowerDownCtrl</b>	Power control register
\$0x03	<b>TxSetup</b>	Transmit set-up register
\$0x04-\$0x07	<b>TxData</b>	Transmit data registers
\$0x08	<b>RxSetup1</b>	Receive set-up control register 1
\$0x09	<b>RxSetup2</b>	Receive set-up control register 2
\$0x0A	<b>AnaCtrl</b>	Analogue configuration control register
\$0x0B	<b>AuxAdcCtrl</b>	Auxiliary ADC data converter control register
\$0x0C	<b>RamDacCtrl</b>	Ram Dac control register
\$0x0D	<b>LoopBackCtrl</b>	Loopback control register
\$0x0E	<b>TxErrorStatus</b>	Transmit error status register
\$0x0F	<b>TxErrStatMask</b>	Transmit error status interrupt mask register

#### Auxiliary Function Registers

\$0x10-\$0x17	<b>AuxAdcData</b>	Auxiliary ADC data registers
\$0x18-\$0x1F	<b>AuxDacData</b>	Auxiliary DAC data registers

#### Status and Interrupt Registers

\$0x20	<b>RxErrorStatus</b>	Receive error status register
\$0x21	<b>RxErrorStatMask</b>	Receive error status interrupt mask register
\$0x22	<b>TxFIFOStatus</b>	Transmission data FIFO status register
\$0x23	<b>TxFIFOStatMask</b>	Tx data FIFO status interrupt mask register

#### Memory I/O Access Points

\$0x24-\$0x2D	<b>CoeffRamData</b>	Coefficient memory I/O access addresses
\$0x2E-\$0x2F		Not Used.

#### Rx Data Path Registers

\$0x30-\$0x31	<b>RxIQGainMult</b>	Receive I channel gain attenuation registers
\$0x32-\$0x33	<b>RxIQOffset</b>	Receive I channel offset correction registers
\$0x34-\$0x35	<b>RxIQGainMult</b>	Receive Q channel gain attenuation registers
\$0x36-\$0x37	<b>RxIQOffset</b>	Receive Q channel offset correction registers



Rx Data Path Access Points

\$0x38-\$0x39	<b>RxDataAccess</b>	Receive path data access point (I)
\$0x3A-\$0x3B	<b>RxDataAccess</b>	Receive path data access point (Q)
\$0x3C-\$0x3F		Not Used

Tx Data Path Registers

\$0x40-\$0x41	<b>TxPhase</b>	Transmit I channel phase correction registers
\$0x42-\$0x43	<b>TxIQGainMult</b>	Transmit I channel gain attenuation registers
\$0x44-\$0x45	<b>TxIQOffset</b>	Transmit I channel offset correction registers
\$0x46-\$0x47	<b>TxPhase</b>	Transmit Q channel phase correction registers
\$0x48-\$0x49	<b>TxIQGainMult</b>	Transmit Q channel gain attenuation registers
\$0x4A-\$0x4B	<b>TxIQOffset</b>	Transmit Q channel offset correction registers
\$0x4C-\$0x4D	<b>TxRampUpInc</b>	Transmit ramp-up increment registers
\$0x4E-\$0x4F	<b>TxRampDnDec</b>	Transmit ramp-down decrement registers

Tx Data Path Access Points

\$0x50-\$0x51	<b>TxDataAccess</b>	Transmit path data access point (I)
\$0x52-\$0x53	<b>TxDataAccess</b>	Transmit path data access point (Q)
\$0x54-\$0x5F		Not Used

Self Test Registers

\$0x60-\$0x61	<b>BISTPRSG</b>	Built-in self test pseudo-random sequence generator
\$0x62	<b>BISTControl</b>	Built-in self test control register
\$0x63		Not Used
\$0x64-\$0x6D	<b>BISTCRCRegisters</b>	Built-in self test cyclic redundancy code checkers
\$0x6E-\$0x6F		Not Used

SRAM Memory Access Points

\$0x70-\$0x73	<b>SramData</b>	Auxiliary DAC1 memory I/O access addresses
\$0x74-\$0x7F		Not Used

Note: Addresses \$0x80 to \$0xFF cannot be used as the MSB controls the direction of data flow:

“1” = High = Read and “0” = Low = Write.

**ConfigCtrl1**

Title: Configuration Control register

Address: \$0x00

Function: RW

Description: General configuration bits, together with operational control signal bits.

Bit	Name	Active	State	Function
7	<i>DataRateHi</i>	High	RW	When set active all serial port data transfers will be at half of the master clock rate. When inactive, all serial port data rates will be at a quarter of the master clock rate. This has the effect of altering the Rx sample output rate from 8 times the symbol rate when active to 4 times when inactive.
6	<i>TxHandshakeEn</i>	High	RW	When set active enable the transmit hardware interlock protocol, thereby stopping the <i>Serial Clock</i> (SClk) if the transmit path is enabled and the transmit FIFO is full.
5	<i>BiDirCmdPortEn</i>	High	RW	When this bit is set active the <i>Cmd</i> port will drive its data line out of the chip for the last 8 bits of read operations. When set inactive command read data will be returned on either the <i>Rx</i> or the <i>CmdRd</i> port (default).
4	<i>RxDataForCmdRdEn</i>	High	RW	This bit only takes effect if the <i>BiDirCmdPortEn</i> bit is inactive. When set active this bit causes all command read operations to respond with data on the <i>Rx</i> serial port. When set inactive the command read data will be output via the <i>CmdRd</i> port (default).
(5,4)	<i>CommandReadDataMode</i>		RW	The <i>BiDirCmdPortEn</i> bit and <i>RxDataForCmdRdEn</i> bit together control the method by which command read data is returned to the user. 00 (Default) Read data returned on <i>CmdRd</i> port. 01 Read data returned on <i>Rx</i> port and <i>CmdRd</i> port 10,11 Read data returned on <i>Cmd</i> port.
3	<i>LowRxRdFS</i>	High	RW	When set active both the <i>CmdRdFS</i> and the <i>RxFS</i> output pins will be driven active low, when set inactive the two frame sync's will be driven active high (default).
2	<i>RxDataPortDisable</i>	High	RW	When set active tristates the <i>RxDat</i> and <i>RxFS</i> pins.
1	<i>RdCmdPortDisable</i>	High	RW	When set active tristates the <i>CmdRdDat</i> and <i>CmdRdFS</i> pins.
0	<i>SymboModuBypass</i>	High	RW	Setting this bit bypasses the Modulator, thereby taking the least significant 3 bits of each Command Transmit Data Serial Word received via the serial interface to represent an absolute constellation mapping.

- **Address and Data format for ConFigCtrl1 access**

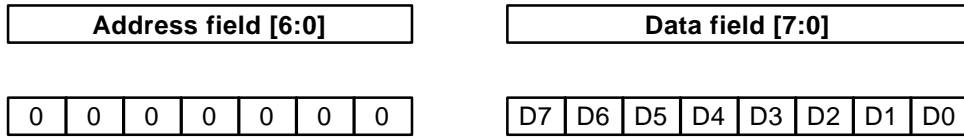

**ConfigCtrl2**

Title: Configuration Control register

Address: \$0x01

Function: RW

Description: General configuration bits, together with operational control signal bits.

Bit	Name	Active State		Function
7			RW	Reserved. Set this bit Low. Undefined on read.
6			RW	User defined bit. This bit has no internal functionality and is reset Low with the global N_RESET pin. The user may employ this bit for any useful purpose.
5	<i>n_SlowDown</i>	Low	RW	When active, this bit reduces the slew rate of digital output pins. This reduces power consumption, ground bounce and reflection problems associated with fast edges on poorly terminated lines. De-activation speeds up the digital outputs, but increases power consumption, ground bounce and reflection problems. It is anticipated that the latter mode will be used only in 3.3V systems.
4	<i>SRamIoRdInc</i>	High	RW	This bit determines whether a read or write operation to the Auxiliary SRAM will increment the address pointers. When set active causes read operations to move the address pointer on, this would therefore allow an efficient write then read verify scheme to be used. When set inactive write operations increment the address pointer.
3	<i>SRamIoEn</i>	High	RW	When set active allows read/write access to the Auxiliary SRAM. It is only valid to activate this bit when the SRAM is not being accessed by the RamDac. When this bit is set active, the first access to <b>SramData</b> will access the first SRAM address location. Subsequent read or write accesses will increment the address pointer to the next memory location.
2	<i>CoeffRamIoRdInc</i>	High	RW	This bit determines whether a read or write operation to a coefficient memory will increment the address pointers. When set active the address pointer is incremented by any coefficient ram read operation, thereby allowing a write then read verification. When set inactive, write operations increment the address pointer.
1	<i>CoeffRamIoEn</i>	High	RW	When set active allows read/write access to all the coefficient memories. This bit is valid only when the Tx and Rx Data paths are inactive. When this bit is set active, the first access to any of the coefficient memories will access the first coefficient location (A1). Subsequent read or write accesses to any coefficient memory will increment the address pointers for all the coefficient memories.

0 *n\_BigEndData* Low RW When set active causes serial port read data, from the *Rx* port to be generated with the MSB data bit as the first serial word bit. If inactive, the LSB is first. On taking N\_RESET Low this bit is active (i.e. the default is MSB first).

- **Address and Data format for ConFigCtrl2 access**

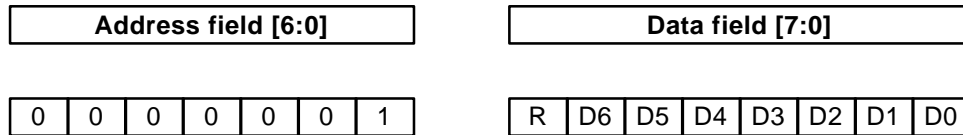

**PowerDownCtrl**

Title: Power Control register

Address: \$0x02

Function: RW

Description: This register, together with the following bits, controls the power saving features:

<i>TxEn</i>	bit of register	<b>TxSetup</b>
<i>RxEn</i>	bit of register	<b>RxSetup1</b>
<i>TxClockStop</i>	bit of register	<b>TxSetup</b>
<i>RxClockStop</i>	bit of register	<b>RxSetup1</b>

Bit	Name	Active	State	Function
7			RW	Reserved. Set this bit Low. Undefined on read.
6	<i>BiasCtrl</i>	High	RW	When set active, increases Tx and Rx analogue bias currents.
5	<i>BiasPowDn</i>	Low	RW	When set active powers down the analogue bias section.
4	<i>AuxDac4PowDn</i>	Low	RW	When set active powers down Auxiliary Dac4.
3	<i>AuxDac3PowDn</i>	Low	RW	When set active powers down Auxiliary Dac3.
2	<i>AuxDac2PowDn</i>	Low	RW	When set active powers down Auxiliary Dac2.
1	<i>AuxDac1PowDn</i>	Low	RW	When set active powers down Auxiliary Dac1.
0	<i>RxAafPowDn</i>	Low	RW	When set active powers down the receive analogue anti-alias filter (AAF).

- **Address and Data format for PowerDownCtrl access**

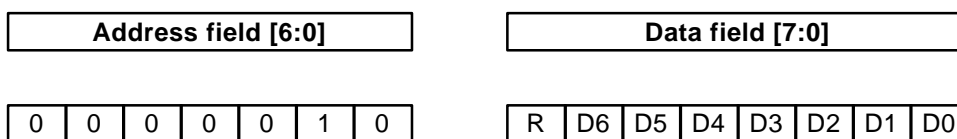

**TxSetup**

Title: Transmit Set-up register  
 Address: \$0x03  
 Function: RW  
 Description: Sets up the transmit functions.

Bit	Name	Active	State	Function
7:4		RW		Reserved. Set these bits Low. Undefined on read.
3	<i>TxClkStop</i>	High	RW	When set active causes the <i>TxEn</i> bit to also be used to gate the Tx Data path master clock. When inactive (default state) the Tx Data path master clock is always supplied.
2	<i>TxEn</i>	High	RW	When set active, enables the Tx Data path, allowing transmission to start when the correct enable sequence has been seen. This bit may only be cleared when the <i>TxPathEn</i> status bit in the <b>TxFIFOStatus</b> register is inactive, setting inactive during a transmission cycle will cause erroneous behaviour. This bit also acts as a transmit section power enable bit.
1	<i>TxRampEn</i>	High	RW	When set active, this bit enables the transmit amplitude ramping function. Ramping is then controlled by the <i>TxRampUp</i> bit of the <b>TxData</b> register. When this bit is inactive, the <i>TxRampUp</i> bit will directly control the transmit amplitude (High meaning full amplitude, Low meaning zero amplitude).
0	<i>TxFirCoeffReset</i>	Low	RW	When set active this bit forces all the Tx Data path filters to load their default coefficient values. This bit will be set active on taking N_RESET Low, and therefore needs to be deactivated before default filter coefficients can be overwritten.

- **Address and Data format for TxSetup access**

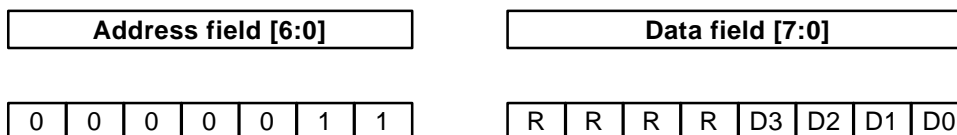

**TxData**

Title: Transmit Data register

Address: \$0x04 - \$0x07 (Mapped over four locations, two address bits being used as data bits)

Function: W FIFO input  
R FIFO output

Description: This transmit data register is 10 bits wide. The two least significant bits of the address bus are used to drive bits 8 and 9, hence it can be considered to be mapped over four consecutive locations. This data word is written into a FIFO. The function is only decoded when the FIFO is read (there is an exception for the first data word). The FIFO will be read when the Tx Data path demands data. This will only occur when the *TxEn* bit of the **TxSetup** register is set active. For test purposes the FIFO data output may be accessed by reading these registers.

**Data write with symbol modulator not bypassed**

Bit	Name	Active	State	Function
9	<i>TxRampUp</i>	High	W	This bit is written to the FIFO. While the <i>TxEn</i> bit of the <b>TxSetup</b> register is active, it controls the Tx Data path ramping. Setting it active will cause the amplitude to ramp up to its full value, conversely setting the bit inactive will cause the amplitude to ramp down to its minimum value. If the bit is changed while the amplitude is being ramped, the ramp direction will change to the direction set by this bit.  While the <i>TxRampEn</i> bit is inactive, the <i>TxRampUp</i> bit will directly control the transmit amplitude (High meaning full amplitude and Low meaning zero amplitude).
8	<i>MultiSymbol</i>	High	W	This bit is written to the FIFO and when this bit is set active, the FIFO symbol data will be marked as a four symbol word. When set inactive, the FIFO symbol data will be marked as a single symbol word. This bit is inactive if the <i>SymbModuBypass</i> bit of the <b>ConfigCtrl1</b> register is active.
7:6	<i>TxRelSymbol4</i>	Data	W	Fourth symbol in word to be written to FIFO.
5:4	<i>TxRelSymbol3</i>	Data	W	Third symbol in word to be written to FIFO.
3:2	<i>TxRelSymbol2</i>	Data	W	Second symbol in word to be written to FIFO.
1:0	<i>TxRelSymbol1</i>	Data	W	First symbol in word to be written to FIFO.

**Data write with symbol modulator bypassed**

Bit	Name	Active	State	Function
9	<i>TxRampUp</i>	High	W	(See above)
8:3	(not used)	Data	W	Redundant data which is still written into the FIFO. Set these bits Low.
2:0	<i>TxAbsSymbol</i>	Data	W	IQ constellation point which is written into the FIFO.



**Read operation**

Bit	Name	Active	State	Function
<u>Address \$0x04</u>				
7:2				Reserved. Bit values are not defined.
1:0	<i>UpperFIFORdData</i>	Data	R	Reads address access bits 9 and 8 of the FIFO data output register, these are placed in bits 1 and 0.
<u>Address \$0x05</u>				
7:0	<i>LowerFIFORdData</i>	Data	R	Reads address access bits 7 to 0 of the FIFO data output register. Reading this location also performs a FIFO read operation, thereby moving the next (if any) FIFO data location into the FIFO data output register.
<u>Address \$0x06 and \$0x07</u>				
7:0			R	Reserved. Bit values are not defined.

For these read operations to be valid, the Tx Data path must be active (*TxEn* bit of **TxSetup** register set active) and the *SymbModuBypass* bit of the **ConfigCtrl1** register must also be set active.



**RxSetup1**

Title: First Receive Set-up control register  
 Address: \$0x08  
 Function: RW  
 Description: Receive path set-up and initialisation control bits.

Bit	Name	Active	State	Function
7	<i>Rx32BitMode</i>	High	RW	When set active, the <i>Rx</i> port operates on 32-bit frames - I data in the MSB word, Q data in the LSB word.
6	<i>RxSampleSel</i>	High	RW	This bit is used to select which pair of I,Q samples is supplied from the possible two when the <i>DataRateHi</i> bit in <b>ConfigCtrl1</b> register is in the low mode (inactive). It has no effect when <i>DataRateHi</i> is active.
5	<i>RxClkStop</i>	High	RW	When set active causes the <i>RxEn</i> bit to also be used to gate the Rx Data path master clock. When inactive (default state) the Rx Data path master clock is always supplied.
4	<i>RxEn</i>	High	RW	When set active, enables the Rx Data path, which then starts to process the differential data on the IRXP,IRXN and QRXP,QRXN pins, outputting results via the <i>Rx</i> serial port. This bit also acts as a receive section power enable bit.
3	<i>RxBistActive</i>	High	RW	When set active, enables Rx Built-In Self Test (BIST) operation.
2	<i>AnaAdcReset</i>	Pulse	W	When this bit is set High, a 4-clock-cycle ADC auto reset event is generated. It is not necessary to clear this bit before another ADC auto reset event is initiated.
			R	The read state of this bit indicates the logic level last written to this bit. It does not have a functional significance and is only available for test purposes.
1	<i>AnaEnAutoReset</i>	Low	RW	When active this bit enables the ADC auto reset function. On taking N_RESET Low, this bit is set active, which is the default operating condition.
0	<i>RxFirCoeffReset</i>	Low	RW	When set active forces all the Rx Data path filters to load their default coefficient values. This bit will be set active on taking N_RESET Low, and therefore needs to be deactivated before default filter coefficients can be overwritten. Normal filter operation is unaffected by leaving this bit set.

- **Address and Data format for RxSetup1 access**

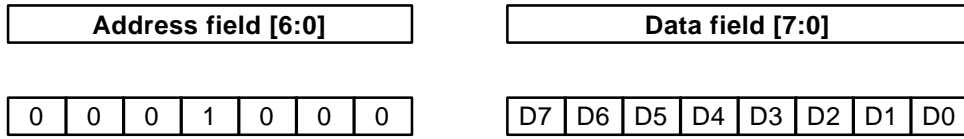

**RxSetup2**

Title: Second Receive Set-up control register

Address: \$0x09

Function: RW

Description: Receive I and Q vernier control bits.

Bit	Name	Active	State	Function
7:4	<i>QvernierDelay</i>	High	RW	Q channel Vernier sampling delay, allowing the sampling point to be adjusted to a resolution of 1/16 of the input sample clock rate.
3:0	<i>IvernierDelay</i>	High	RW	I channel Vernier sampling delay, allowing the sampling point to be adjusted to a resolution of 1/16 of the input sample clock rate.

Note: The values are in the format of 4 bit signed 2s-complement integers - the MSB being the sign. Thus it can be interpreted as adjusting the reference phase by  $\pm 7/16$  of the sample clock period.

- **Address and Data format for RxSetup2 access**



**AnaCtrl**

Title: Analogue configuration Control register  
Address: \$0x0A  
Function: RW  
Description: Reserved. All bits should be set Low.

**AuxAdcCtrl**

Title: Auxiliary ADC data converter Control register

Address: \$0x0B

Function: RW

Description: This register controls the operation of the four ADC channels. These are implemented using a single ADC converter which is multiplexed on to each of the ADC channels. A conversion cycle consists of performing a conversion for each of the active channels in turn.

Bit	Name	Active	State	Function
7			RW	Reserved. Set this bit Low. Undefined on read.
6	<i>AdcConvertRate</i>	High	RW	This bit changes the ADC conversion rate. If this bit is set Low, the ADC is clocked by MCLK/8, yielding a conversion time of 80x MCLK periods per ADC channel. The maximum sample rate is lower than this. With a single channel selected, the maximum rate is MCLK/112 samples/second. Setting this bit high will halve the ADC clock rate, and hence double the conversion time.
5	<i>AdcContConv</i>	High	RW	Continuous conversion mode control bit; when inactive, sets the ADCs into one-shot conversion mode; when active, the ADCs will continuously convert. One-shot conversion mode is initiated by the <i>StartConvert</i> bit. In continuous convert mode, the ADC will start a new conversion cycle on all active channels after the previous cycle has completed.
4	<i>EnableAdc4</i>	High	RW	Setting this bit high will enable ADC channel 4 for conversion. This bit may be updated at any time, but will only change the active state of the ADC channel for the next time it is converted.
3	<i>EnableAdc3</i>	High	RW	Setting this bit high will enable ADC channel 3 for conversion. This bit may be updated at any time, but will only change the active state of the ADC channel for the next time it is converted.
2	<i>EnableAdc2</i>	High	RW	Setting this bit high will enable ADC channel 2 for conversion. This bit may be updated at any time, but will only change the active state of the ADC channel for the next time it is converted.
1	<i>EnableAdc1</i>	High	RW	Setting this bit high will enable ADC channel 1 for conversion. This bit may be updated at any time, but will only change the active state of the ADC channel for the next time it is converted.

0	<i>StartConvert</i>	High	One-shot conversion control bit. Only valid when the ADCs are set to one-shot conversion mode.
		W	Setting this bit High starts the ADC data conversion. Setting this bit Low will stop the conversion. This should only be used for test purposes, because the ADC conversion logic will automatically set this bit Low when the conversion operation has completed.
		R	This bit can be set High or Low by the serial interface, but the ADC conversion logic will automatically set it Low when the current conversion cycle has completed.

- **Address and Data format for Auxillary ADC Control access**

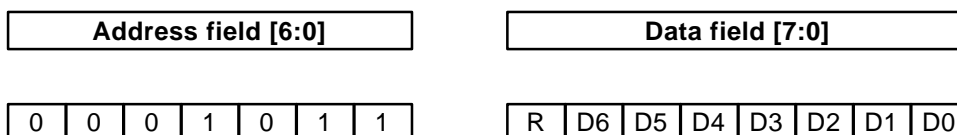



**AuxAdcData**

Title: Auxiliary ADC Data registers

Address: (Eight registers) \$0x10 to \$0x17

Function: R

Description: These registers enable the user to inspect the conversion value for each of the four auxiliary ADCs. There are two read registers per ADC, one to obtain the least significant two bits of the data, the other for the most significant eight bits. Reading these registers does not affect the ADC conversion cycle. Reading the MSB read register directly reads the ADC output and simultaneously causes the two bits in the LSB read register to be written into a holding register. This holding register is read when the LSB read register is read. This mechanism is necessary to allow the user to read MSB and LSB data from the same ADC conversion cycle. If only the MSB read register is read, the converter can be considered as an 8-bit ADC. If a 10-bit conversion is required, the MSB read register must be read first.

Bit	Name	Active State	Function
<u>Address \$0x10</u>			
7:0	<i>Adc1MsbData</i>	Data R	Most significant eight bits of the data from the last conversion of <i>AuxAdc1</i> .
<u>Address \$0x11</u>			
7:2		R	Reserved. Bit values are not defined.
1:0	<i>Adc1LsbData</i>	Data R	Least significant two bits of the data from the last conversion of <i>AuxAdc1</i> .
<u>Address \$0x12</u>			
7:0	<i>Adc2MsbData</i>	Data R	Most significant eight bits of the data from the last conversion of <i>AuxAdc2</i> .
<u>Address \$0x13</u>			
7:2		R	Reserved. Bit values are not defined.
1:0	<i>Adc2LsbData</i>	Data R	Least significant two bits of the data from the last conversion of <i>AuxAdc2</i> .
<u>Address \$0x14</u>			
7:0	<i>Adc3MsbData</i>	Data R	Most significant eight bits of the data from the last conversion of <i>AuxAdc3</i> .
<u>Address \$0x15</u>			
7:2		R	Reserved. Bit values are not defined.
1:0	<i>Adc3LsbData</i>	Data R	Least significant two bits of the data from the last conversion of <i>AuxAdc3</i> .
<u>Address \$0x16</u>			
7:0	<i>Adc4MsbData</i>	Data R	Most significant eight bits of the data from the last conversion of <i>AuxAdc4</i> .
<u>Address \$0x17</u>			
7:2		R	Reserved. Bit values are not defined.
1:0	<i>Adc4LsbData</i>	Data R	Least significant two bits of the data from the last conversion of <i>AuxAdc4</i> .

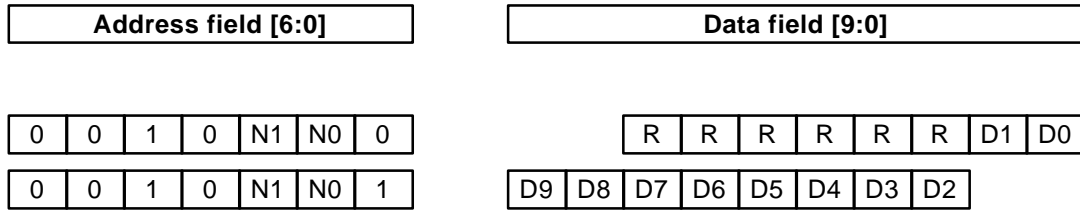
**Address and Data format for Auxillary ADC Data access**

N1 N0 ADC Channel

0	0	Channel 1
0	1	Channel 2
1	0	Channel 3
1	1	Channel 4

**RamDacCtrl**

Title: RamDac Control register

Address: \$0x0C

Function: RW

Description: This register controls the operation of DAC 1, together with the operation of the memory (DacSram) which can be used to drive the digital input of DAC 1.

Bit	Name	Active	State	Function
7:6		RW		Reserved. These bits should be set Low. Undefined on read.
5:3	<i>RamDacRate</i>	High	RW	These three bits set the rate at which the RamDac memory's DAC access address pointer changes. The three bit value ( <i>RamDacRate</i> ) causes a change rate of $(36 \times 2^{\text{RamDacRate}})$ kHz. See table below.
2	<i>RamDacInc</i>	High	RW	This bit activates the RamDac memory scan operation. Setting it active will cause the memory address to increment up to the top (highest) location, conversely setting the bit inactive will cause the memory address to decrement down to the bottom location. If the bit is changed while the memory is being scanned, the current scan will complete before the new state of the <i>RamDacInc</i> bit takes effect.
1	<i>AutoCycle</i>	High	RW	This bit is only valid if the <i>RamDacActive</i> bit is active. When set active, the Auxiliary SRAM memory will be continually scanned at the rate set by the <i>RamDacRate</i> bits. This enables a symmetrical periodic waveform to be driven out on the AUXDAC1 pin. The Auxiliary SRAM address cycles from the bottom location up to the top location, and back down to the bottom again.
0	<i>RamDacActive</i>	High	RW	DAC 1 input mode bit. When inactive, the <b>AuxDacData</b> registers (offsets 0 and 1) are used as the source for conversion. If this bit is active, the DAC is driven from the output of the RamDac memory.

**Ram Dac Rate Select Table**

RamDacCtrl[5:3]	Dac Update Frequency (kHz)
0 0 0	36
0 0 1	72
0 1 0	144
0 1 1	288
1 0 0	576
1 0 1	1152
1 1 0	2304
1 1 1	4608

- Address and Data format for RamDacCtrl access

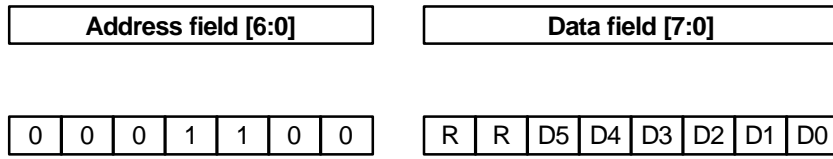

**AuxDacData**

Title: Auxiliary DAC Data registers

Address: (Eight registers) \$0x18 to \$0x1F

Function: RW

Description: There are two input registers for each of the four auxiliary DACs. Writing to the *AuxDac#LsbData* register writes the least significant two bits of DAC data. Writing to the *AuxDac#MsbData* register writes the most significant eight bits of DAC data and then passes all ten bits to the appropriate DAC input (only if the *RamDacActive* bit is set Low for DAC 1). If the *AuxDac#MsbData* register is written while the *AuxDac#LsbData* register is left constant, the converter may be treated as an 8-bit DAC.

Bit	Name	Active State	Function
<u>Address \$0x18</u>			
7:2		RW	Reserved. These bits should be set Low. Undefined on read.
1:0	<i>AuxDac1LsbData</i>	Data RW	Writing to this address writes the least significant two bits of the <i>DacData1</i> register. These two bits may be read for test purposes.
<u>Address \$0x19</u>			
7:0	<i>AuxDac1MsbData</i>	Data RW	Writing to this address writes the most significant eight bits of the <i>DacData1</i> register and updates DAC 1. This register may also be read for test purposes.
<u>Address \$0x1A</u>			
7:2		RW	Reserved. These bits should be set Low. Undefined on read.
1:0	<i>AuxDac2LsbData</i>	Data RW	Writing to this address writes the least significant two bits of the <i>DacData2</i> register. These two bits may be read for test purposes.
<u>Address \$0x1B</u>			
7:0	<i>AuxDac2MsbData</i>	Data RW	Writing to this address writes the most significant eight bits of the <i>DacData2</i> register and updates DAC 2. This register may also be read for test purposes.
<u>Address \$0x1C</u>			
7:2		RW	Reserved. These bits should be set Low. Undefined on read.
1:0	<i>AuxDac3LsbData</i>	Data RW	Writing to this address writes the least significant two bits of the <i>DacData3</i> register. These two bits may be read for test purposes.
<u>Address \$0x1D</u>			
7:0	<i>AuxDac3MsbData</i>	Data RW	Writing to this address writes the most significant eight bits of the <i>DacData3</i> register and updates DAC 3. This register may also be read for test purposes.
<u>Address \$0x1E</u>			
7:2		RW	Reserved. These bits should be set Low. Undefined on read.
1:0	<i>AuxDac4LsbData</i>	Data RW	Writing to this address writes the least significant two bits of the <i>DacData4</i> register. These two bits may be read for test purposes.

Address \$0x1F

7:0 *AuxDac4MsbData* Data RW Writing to this address writes the most significant eight bits of the *DacData4* register and updates DAC 4. This register may also be read for test purposes.

- **Address and Data format for Auxillary DAC Data access**

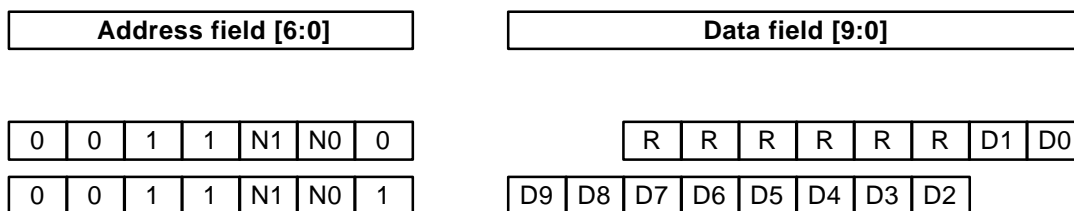

N1 N0 Channel Selected

0	0	Channel 1
0	1	Channel 2
1	0	Channel 3
1	1	Channel 4

**LoopBackCtrl**

Title: LoopBack Control register

Address: \$0x0D

Function: RW

Description: This register is only used for test purposes. For normal operation all these bits should be inactive.

Bit	Name	Active	State	Function
7:6			RW	Reserved. These bits should be set Low. Undefined on read.
5	<i>FirReset</i>	High	RW	When active, this bit holds all FIR filters in reset, by resetting the FIR address pointers. This by itself does not reset the data register RAMs. A separate access is provided to disable the complete Tx or Rx Data path. Taking N_RESET Low will also reset the FIR filter coefficients to their default values.
4	<i>DigLoopBack</i>	High	RW	When set active this bit enables the digital loopback feature. This connects the output of the Rx Data path 49-tap filter to the input of the Tx Data path 49-tap digital filter, thereby allowing an analogue signal presented at the Rx inputs to be filtered by a raised cosine filter and monitored at the Tx outputs as an analogue signal.
3	<i>AnaLoopBack</i>	High	RW	When set active this bit enables the analogue loopback feature. This connects the output of the Tx Data path DAC to the input of Rx Data path ADC, thus passing transmit constellation data through a raised cosine filter and allowing the resultant data samples to be monitored digitally at the Rx output.
2	<i>RxDPAccessSel</i>	High	RW	When set active this bit disables the Rx Data path sample clock, thereby enabling the Data path access register to directly update the output of the Rx Data path operator.
1	<i>TxDPAccessSel</i>	High	RW	When set active this bit disables the Tx Data path sample clock, thereby enabling the Data path access register to directly update the input to the 15-tap digital filter without the data being overridden by subsequent sample clocks
0	<i>TxtoRxDataPath</i>	High	RW	When set active this bit connects the Tx (I,Q) DAC input to the serial receive port (Rx). This enables the output of the transmit 15-tap filter to be observed in real time. Data is taken from the I and Q channels on alternate 144kHz sample clocks.

- **Address and Data format for LoopBackCtrl access**

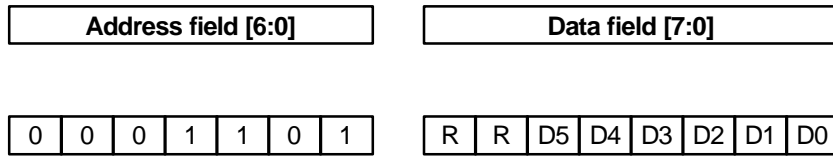



**TxErrorStatus**

Title: Transmit Error Status register.

Address: \$0x0E

Function: R

Description: This register is the Tx Data path error status register. The *TxIrqActive* bit is set active when one of the other bits in this register is the source of an interrupt event. All these error conditions are caused by transitory events, therefore the error condition is latched (marked with an 'L'). Reading this status register causes all latched bits to be set inactive, unless an error event is currently pending.

Setting any bit of this register High will cause an interrupt to be generated (N\_IRQ will be set Low) if the source of the interrupt has not been masked in the corresponding Mask register.

Bit	Name	Active	State	Function
7		R		Reserved. Bit value is not defined.
6	<i>TxDataPathQOF</i>	High	RL	Data path gain, phase and offset (GPO) adjustment-unit: Q channel overflow error status bit.
5	<i>TxDataPathIOF</i>	High	RL	Data path gain, phase and offset (GPO) adjustment-unit: I channel overflow error status bit.
4	<i>Tx15tapQOF</i>	High	RL	15-tap Q filter data accumulator overflow error status bit.
3	<i>Tx15tapIOF</i>	High	RL	15-tap I filter data accumulator overflow error status bit.
2	<i>Tx49tapOF</i>	High	RL	49-tap I and Q filter data accumulator overflow error status bit.
1	<i>Tx79tapOF</i>	High	RL	79-tap I and Q filter data accumulator overflow error status bit.
0	<i>TxIrqActive</i>	High	RL	This bit is set High if there is an active interrupt caused by one of the status bits in this register.

• **Address and Data format for TxErrorStatus access**

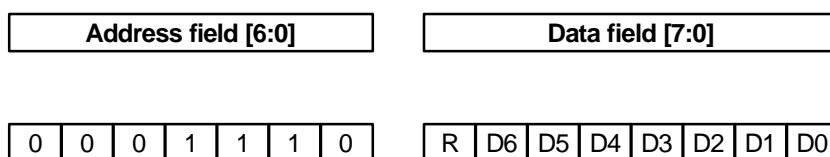

**TxErrStatMask**

Title: Transmit Error Status interrupt Mask register

Address: \$0x0F

Function: RW

Description: Masks interrupts in the **TxErrorStatus** register. On taking N\_RESET Low, these bits are set active, so masking out all possible interrupt sources. Each bit which is taken inactive will allow its associated status bit, when active, to generate an interrupt.

Bit	Name	Active	State	Function
7		Data	RW	Reserved for manufacturer's test purposes. This bit should be set Low.
6	<i>n_TxDataPathQOF_Mask</i>	Low	RW	GPO Q channel error interrupt mask bit.
5	<i>n_TxDataPathIOF_Mask</i>	Low	RW	GPO I channel error interrupt mask bit.
4	<i>n_Tx15tapQOF_Mask</i>	Low	RW	15-tap Q filter error interrupt mask bit.
3	<i>n_Tx15tapIOF_Mask</i>	Low	RW	15-tap I filter error interrupt mask bit.
2	<i>n_Tx49tapOF_Mask</i>	Low	RW	49-tap I and Q filter error interrupt mask bit.
1	<i>n_Tx79tapOF_Mask</i>	Low	RW	79-tap I and Q filter error interrupt mask bit.
0		Data		Reserved for manufacturer's test purposes. This bit should be set Low.

• **Address and Data format for TxErrStatMask access**

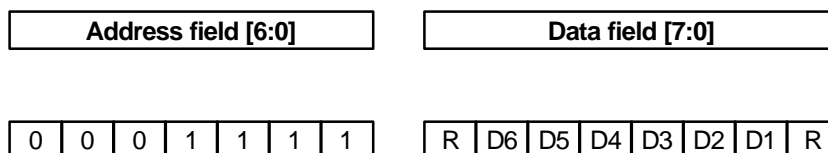

**RxErrorStatus**

Title: Receive Error Status register.

Address: \$0x20

Function: R

Description: This register is the Rx Data path error status register. The *RxIrqActive* bit is set active when one of the other bits in this register is the source of an interrupt event. All these error conditions are caused by transitory events, therefore the error condition is latched (marked with an 'L'). Reading this status register causes all latched bits to be set inactive unless an error event is currently pending.

Setting any bit of this register High will cause an interrupt to be generated (N\_IRQ will be set Low) if the source of the interrupt has not been masked in the corresponding Mask register.

Bit	Name	Active	State	Function
7	<i>RxDataPathQOF</i>	High	RL	Data path gain, phase and offset (GPO) adjustment unit: Q channel overflow error status bit.
6	<i>RxDataPathIOF</i>	High	RL	Data path gain, phase and offset (GPO) adjustment unit: I channel overflow error status bit.
5	<i>AdcQOF</i>	High	RL	ADC Q channel overflow error due to excessive input amplitude.
4	<i>AdcIOF</i>	High	RL	ADC I channel overflow error due to excessive input amplitude.
3	<i>Rx63tapOF</i>	High	RL	63-tap I and Q filter data accumulator overflow error status bit.
2	<i>Rx49tapOF</i>	High	RL	49-tap I and Q filter data accumulator overflow error status bit.
1	<i>EvenSamplePhase</i>	High	RL	When this status bit is active, the associated interrupt may be used to re-synchronise the Rx data if for any reason data synchronisation is lost. If the corresponding mask bit is set inactive, an interrupt will be generated on the next Q-phase data in the Rx output register. The next falling edge of SClk with RxFS High indicates the LSB of the Q channel data. The mask bit should be disabled after this to prevent continuous Q-phase interrupts.
0	<i>RxIrqActive</i>	High	RL	This bit is set High if there is an active interrupt caused by one of the status bits in this register.

• **Address and Data format for RxErrorStatus access**

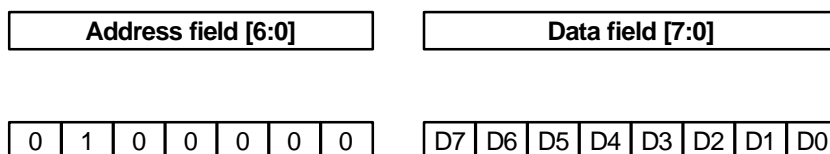

**RxErrorStatMask**

Title: Receive Error Status interrupt Mask register.

Address: \$0x21

Function: RW

Description: Masks interrupts in the **RxErrorStatus** register. On taking N\_RESET Low, these bits are set active, so masking out all possible interrupt sources. Each bit which is taken inactive will allow its associated status bit, when active, to generate an interrupt.

Bit	Name	Active	State	Function
7	<i>n_RxDataPathQOF_Mask</i>	Low	RW	GPO Q channel error interrupt mask bit.
6	<i>n_RxDataPathIOF_Mask</i>	Low	RW	GPO I channel error interrupt mask bit.
5	<i>n_AdcQOF_Mask</i>	Low	RW	ADC Q channel error interrupt mask bit.
4	<i>n_AdcIOF_Mask</i>	Low	RW	ADC I channel error interrupt mask bit.
3	<i>n_Rx63tapOF_Mask</i>	Low	RW	63-tap I and Q filter error interrupt mask bit.
2	<i>n_Rx49tapOF_Mask</i>	Low	RW	49-tap I and Q filter error interrupt mask bit.
1	<i>EvenSamplePhase_Mask</i>	Low	RW	Rx data Q-phase interrupt mask bit.
0		Data	RW	Reserved for manufacturer's test purposes. This bit should be set Low.

• **Address and Data format for RxStatMask access**

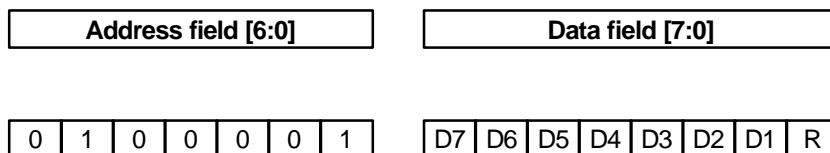

**TxFIFOStatus**

Title: Transmit data FIFO Status register

Address: \$0x22

Function: R

Description: This register is the Tx Data FIFO status register. The *TxIrqActive* bit is set active when one of the other bits in this register is the source of an interrupt event. Some of these status conditions are caused by transitory events, therefore their state is latched (marked with an 'L'). The bits marked with a parenthesised 'L' are only latched in their interrupt generation state if their associated mask bit is inactive. Reading this status register causes all latched bits to be set inactive, unless an error event is currently pending.

Setting any bit of this register High will cause an interrupt to be generated (N\_IRQ will be set Low) if the source of the interrupt has not been masked in the corresponding Mask register.

Bit	Name	Active State	Function
7	<i>TxPathEn</i>	High/ Low R(L)	When active (High) this bit shows that the Tx Data path is currently active. This enables the user to confirm that ramp down has completed.  For interrupt generation purposes, a logic Low on this bit will be considered as active.
6	<i>FIFOUnderRead</i>	High RL	Error status bit. When active indicates a read from the FIFO occurred while the FIFO was empty.
5	<i>FIFOOverWrite</i>	High RL	Error status bit. When active indicates a write to the FIFO occurred while the FIFO was full.
4	<i>FIFOFull</i>	High/ Low R(L)	Most significant FIFO length status bit. When active (High) this bit also indicates the FIFO is full.  For interrupt generation purposes, a logic Low on this bit will be considered as active.
3:2	<i>FIFOLength</i>	(Low) R(L)	These two bits contain the pointer to the next free FIFO address and indicate the following status: 00 - indicates FIFO is empty 01 - one location used 10 - two locations used 11 - three locations used  For interrupt generation purposes, a logic Low on either of these bits will be considered as active.
1	<i>FIFOEmpty</i>	High R(L)	When active indicates the FIFO is empty.
0	<i>FifoIrqActive</i>	High RL	This bit is set High if there is an active interrupt caused by one of the status bits in this register.

- **Address and Data format for TxFIFOStatus access**

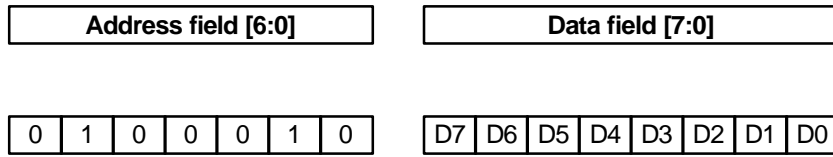

**TxFIFOStatMask**

Title: Transmit data FIFO Status interrupt Mask register

Address: \$0x23

Function: RW

Description: Masks interrupts in the **TxFIFOStatus** register. On taking N\_RESET Low, these bits are set active, so masking out all possible interrupt sources. Each inactive bit will allow its associated status bit to generate an interrupt. In the case of the status bits marked in the **TxFIFOStatus** register with a parenthesised 'L', taking the mask bit inactive will enable the latching mechanism.

Bit	Name	Active	State	Function
7	<i>n_TxPathEn_Mask</i>	Low	RW	Tx Data path active interrupt mask bit.
6	<i>n_FIFOUnderRead_Mask</i>	Low	RW	FIFO underflow interrupt mask bit.
5	<i>n_FIFOOverWrite_Mask</i>	Low	RW	FIFO overflow interrupt mask bit.
4	<i>n_FIFOFull_Mask</i>	Low	RW	FIFO full interrupt mask bit.
3	<i>n_FIFOLength1_Mask</i>	Low	RW	FIFO length status (MSB) interrupt mask bit.
2	<i>n_FIFOLength0_Mask</i>	Low	RW	FIFO length status (LSB) interrupt mask bit.
1	<i>n_FIFOEmpty_Mask</i>	Low	RW	FIFO empty interrupt mask bit.
0		Data	RW	Reserved for manufacturer's test purposes. This bit should be set Low.

• **Address and Data format for TxFIFOStatMask access**

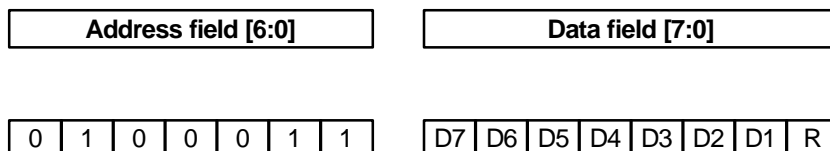

**CoeffRamData**

Title: I/O access addresses for the five coefficient memories.

Address: \$0x24 to \$0x2D (mapped over 10 locations)

Function: RW

Description: Each coefficient RAM has both MSB and LSB address ports assigned for read/write access. There are three transmit (Tx) FIR filters with read/write coefficients and two receive (Rx) filters, with coefficient sizes of 12 and 16 bits respectively. Access to the coefficient memory is valid when the *CoeffRamLoEn* bit is active.

Asserting the *CoeffRamLoEn* will reset the *Coefficient Address Pointer* to the first location (A1). The MSB port should be accessed first, as accessing the LSB port will move the *Coefficient Address Pointer* to the next coefficient location (A[n+1]) (refer to description of *CoeffRamLoRdInc* bit for details). Subsequent accesses to the LSB port of the coefficient address will increment the *Coefficient Address Pointer*.

As all filters are symmetrical and “odd”, only  $\frac{N + 1}{2}$  locations can be programmed, where  $N$  is the filter tap length. Performing an I/O access after the last *Coefficient Address Pointer* is not valid, and may corrupt existing coefficients. Only one FIR filter coefficient RAM may be accessed at a time. If further memories are to be accessed then the *CoeffRamLoEn* must first be deactivated, and then activated again, allowing the next FIR filter coefficient RAM to be incrementally accessed.

Bit	Name	Active State	Function
<u>Address \$0x24</u>			
7:0	<i>Tx15tapCoeffLSB</i>	Data RW	Transmit 15-tap filter LSB coefficient data port. Post-increment the coefficient address pointer.
<u>Address \$0x25</u>			
7:4		RW	Reserved. Set these bits High. Undefined on read.
3:0	<i>Tx15tapCoeffMSB</i>	Data RW	Transmit 15-tap filter MSB coefficient data port.
<u>Address \$0x26</u>			
7:0	<i>Tx49tapCoeffLSB</i>	Data RW	Transmit 49-tap filter LSB coefficient data port. Post-increment the coefficient address pointer.
<u>Address \$0x27</u>			
7:4		RW	Reserved. Set these bits High. Undefined on read.
3:0	<i>Tx49tapCoeffMSB</i>	Data RW	Transmit 49-tap filter MSB coefficient data port.
<u>Address \$0x28</u>			
7:0	<i>Tx79tapCoeffLSB</i>	Data RW	Transmit 79-tap filter LSB coefficient data port. Post-increment the coefficient address pointer.
<u>Address \$0x29</u>			
7:4		RW	Reserved. Set these bits High. Undefined on read.
3:0	<i>Tx79tapCoeffMSB</i>	Data RW	Transmit 79-tap filter MSB coefficient data port.
<u>Address \$0x2A</u>			
7:0	<i>Rx49tapCoeffLSB</i>	Data RW	Receive 49-tap filter LSB coefficient data port. Post-increment the coefficient address pointer.



Address \$0x2B

7:0 *Rx49tapCoeffMSB* Data RW Receive 49-tap filter MSB coefficient data port.

Address \$0x2C

7:0 *Rx63tapCoeffLSB* Data RW Receive 63-tap filter LSB coefficient data port.  
Post-increment the coefficient address pointer.

Address \$0x2D

7:0 *RX63tapCoeffMSB* Data RW Receive 63-tap filter MSB coefficient data port.

- **Address and Data format for 15-tap Tx FIR Coefficient Ram IO access**

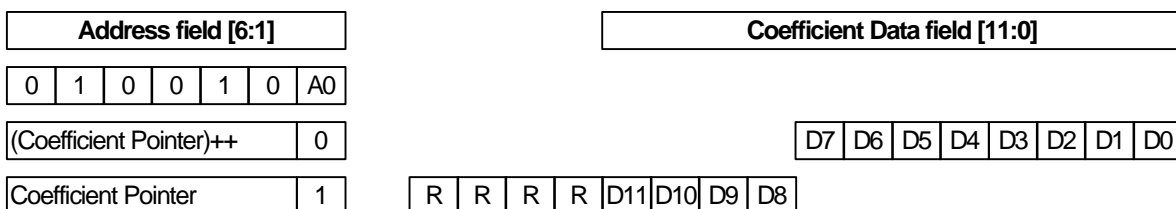

- **Address and Data format for 49-tap Tx FIR Coefficient Ram IO access**

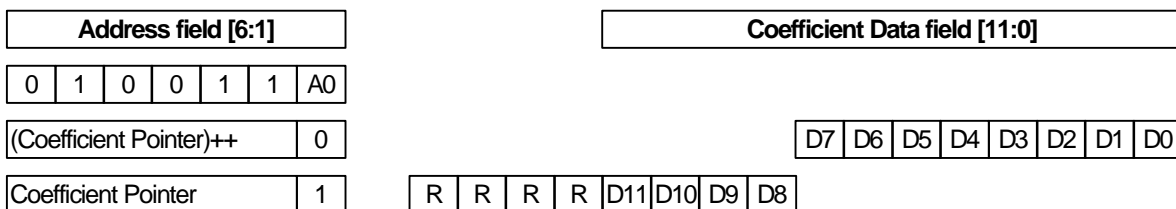

- **Address and Data format for 79-tap Tx FIR Coefficient Ram IO access**

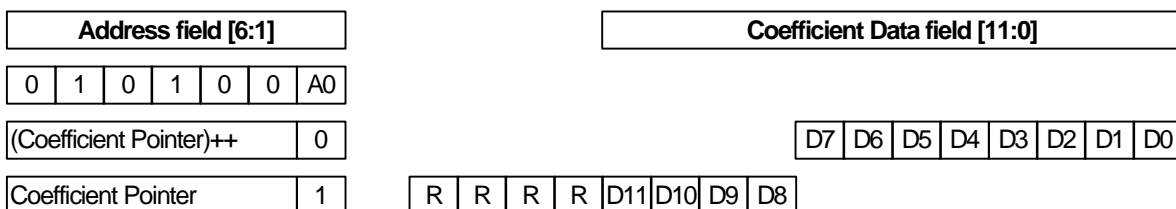

- **Address and Data format for 49-tap Rx FIR Coefficient Ram IO access**

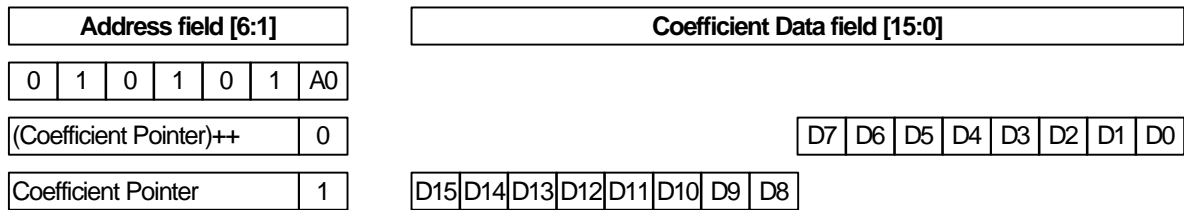

- **Address and Data format for 63-tap Rx FIR Coefficient Ram IO access**

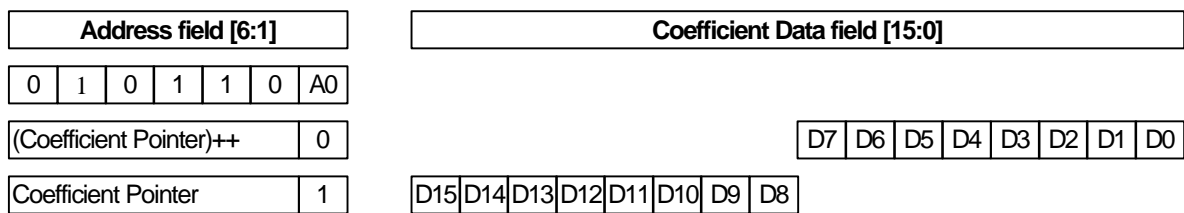

## SramData

Title: I/O access address for the auxiliary DAC1 memories.

Address: \$0x70 to \$0x73 (mapped over 4 locations)

Function: RW

Description: These four address locations allow access to the 64 x 10 bit SRAM. The contents of this RAM can be pre-loaded with a table of values which can be automatically sent to auxiliary DAC1 in either a single cycle or continuous mode, see RamDacCtrl for details. Therefore the RAM can be used in conjunction with DAC1 to enable user defined profile power ramping of an external RF power transmitter stage.

The RAM contents are addressed incrementally by first taking the *SRamIoEn* bit active. While this bit is inactive the *SRam Address Pointer* is held reset. The physical address applied to the RAM is formed from the 4-bit *SRam Address Pointer* and the two LSB bits from the I/O Access address (A1,A0). Therefore four locations in the RAM can be accessed by directly addressing \$0x70 to \$0x73. However, accessing location \$0x73 post-increments (by a block of four addresses) the *SRam Address Pointer*, thus moving the pointer to the next RAM location block.

The 10-bit data word is split between “odd” and “even” locations with the MSB byte in “odd” addresses (A0 = 1) and 2 LSB’s in “even” addresses.

The *SRamIoRdInc* bit determines whether a read or a write operation will increment the *SRam Address Pointer*. All 16 locations are accessed incrementally, further accesses to this port while the *SRamIoEn* bit is active are not valid and may cause data loss.

Bit	Name	Active State	Function
<u>Address \$0x70</u>			
7:2		RW	Reserved. Set these bits Low. Undefined on read.
1:0	<i>SRamLSBPort0</i>	Data RW	Access port for the LSB register.
<u>Address \$0x71</u>			
7:0	<i>SRamMSBPort0</i>	Data RW	Access port for the MSB register
<u>Address \$0x72</u>			
7:2		RW	Reserved. Set these bits Low. Undefined on read.
1:0	<i>SRamLSBPort1</i>	Data RW	Access port for the LSB register.
<u>Address \$0x73</u>			
7:0	<i>SRamMSBPort3</i>	Data RW	Access port for the MSB register. Post-increment <i>Sram</i> address pointer.

• **Address and Data format for Sram Data I/O access**

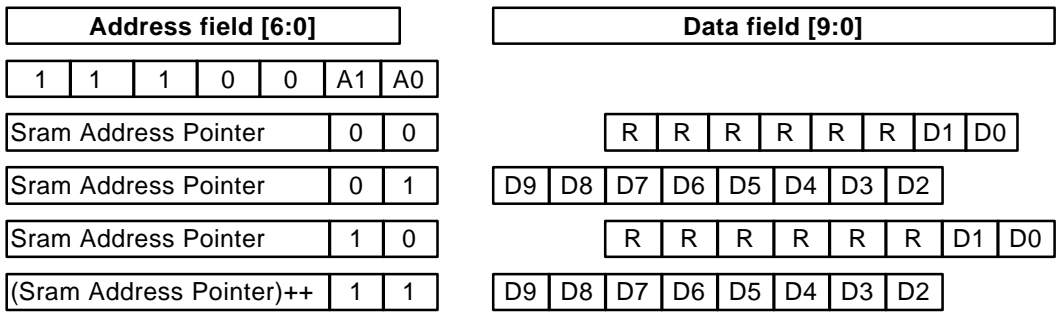

**TxRampUpInc**

Title: Transmit Ramp Up Increment registers.

Address: \$0x4C to \$0x4D (mapped over 2 locations)

Function: RW

Description: The value in this register sets the scale of the Tx amplitude gain increments which occur over each sample clock period, thus determining the Tx amplitude ramp up time period. The value is always positive. The ramp up rate, in terms of the number of symbols, is given by the formula:

$$N_{symbols} = \frac{64}{N_{inc}}$$

Where:  $N_{symbols}$  is the ramp time in terms of number of symbols.  
 $N_{inc}$  is the value in the register.

Bit	Name	Active State	Function
<u>Address \$0x4C</u>			
7:0	<i>RampUpIncLSB</i>	Data RW	Least significant 8 bits of the ramp up increment register.
<u>Address \$0x4D</u>			
7:1		RW	Reserved. Set these bits Low. Undefined on read.
0	<i>RampUpIncMSB</i>	Data RW	Most significant bit of the ramp up increment register.

• **Address and Data format for TxRampUpInc access**

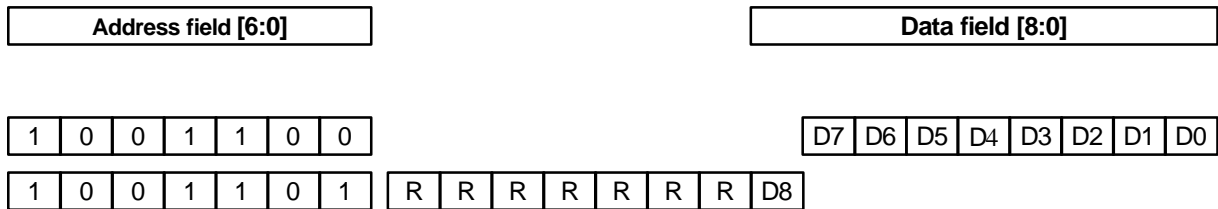

**TxRampDnDec**

Title: Transmit Ramp Down Decrement registers.

Address: \$0x4E to \$0x4F (mapped over 2 locations)

Function: RW

Description: The value in this register sets the scale of the Tx amplitude gain decrements which occur over each sample clock period, thus determining the Tx amplitude ramp down time period. The value is always positive. The ramp down rate, in terms of the number of symbols, is given by the formula:

$$N_{symbols} = \frac{64}{N_{inc}}$$

Where:  $N_{symbols}$  is the ramp time in terms of number of symbols.  
 $N_{inc}$  is the value in the register.

Bit	Name	Active State	Function
<u>Address \$0x4E</u>			
7:0	<i>RampDnIncLSB</i>	Data RW	Least significant 8 bits of the ramp down increment register.
<u>Address \$0x4F</u>			
7:1		RW	Reserved. Set these bits Low. Undefined on read.
0	<i>RampDnIncMSB</i>	Data RW	Most significant bit of the ramp down increment register.

• **Address and Data format for TxRampDnDec access**

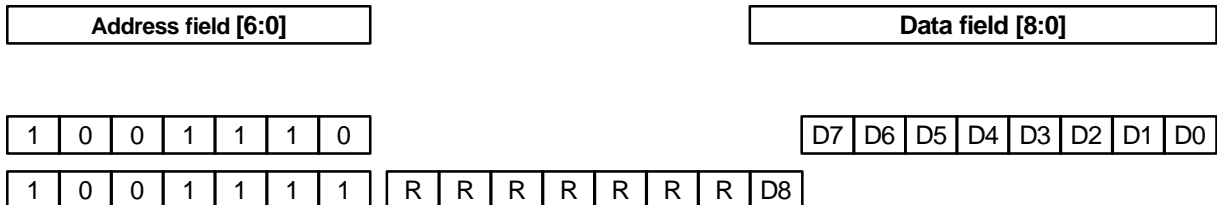

**TxIQGainMult**

Title: Transmit I and Q channel Gain Multiplier registers

Address: \$0x42, \$0x43 , \$0x48 and \$0x49 (4 locations)

Function: RW

Description: A 2s-complement multiplication is performed on the magnitude of the Tx Data path signal and the result is then re-normalised to the system's dynamic range: thus the function may be considered as a digital attenuator. This register sets the multiplier, the result being given by the formula:

$$D_{out} = D_{in} \left[ \frac{G_{val}}{2^{II}} \right]$$

Where:  $D_{in}$  is the signal input,  
 $D_{out}$  is the signal output,  
 $G_{val}$  is the value in the register.

Bit	Name	Active State	Function
<u>Address \$0x42</u>			
7:0	<i>TxIGainLSB</i>	Data RW	Least significant 8 bits of the TxIGain register ( $G_{val}$ ).
<u>Address \$0x43</u>			
7:3		RW	Reserved. Set these bits Low. Undefined on read.
2:0	<i>TxIGainMSB</i>	Data RW	Most significant 3 bits of the TxIGain register ( $G_{val}$ ).
<u>Address \$0x48</u>			
7:0	<i>TxQGainLSB</i>	Data RW	Least significant 8 bits of the TxQGain register ( $G_{val}$ ).
<u>Address \$0x49</u>			
7:3		RW	Reserved. Set these bits Low. Undefined on read.
2:0	<i>TxQGainMSB</i>	Data RW	Most significant 3 bits of the TxQGain register ( $G_{val}$ ).

- **Address and Data format for TxIGain access**

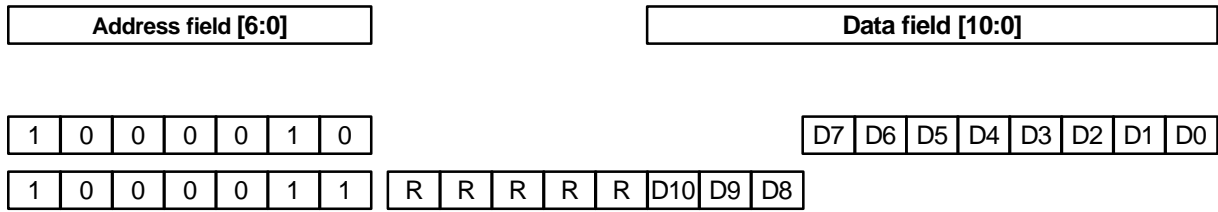

- **Address and Data format for TxQGain access**

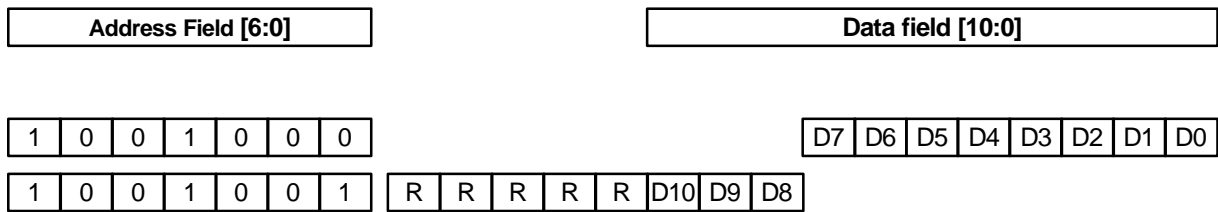



**TxIQOffset**

Title: Transmit I and Q channel Offset correction register

Address: \$0x44, \$0x45, \$0x4A, and \$0x4B (4 locations)

Function: RW

Description: This register controls the Tx Data path signal offset. This offset is a 2s-complement value ( $N_{offset}$ ), which is applied to the Tx signal after the Gain Multiplier ( $G_{val}$ ), but before the DAC. The offset applied is at the discretion of the user. Inappropriate values may cause arithmetic overflow in the subsequent operator sections. The result is given by the formula:

$$D_{out} = D_{in} + \left[ \frac{N_{offset}}{2^{15}} \right]$$

Where:  $D_{in}$  is the signal input,  
 $D_{out}$  is the signal output,  
 $N_{offset}$  is the 2s-complement value in the register.

Bit	Name	Active State	Function
<u>Address \$0x44</u>			
7:0	<i>TxIOffsetLSB</i>	Data RW	Least significant 8 bits of the TxIOffset register ( $N_{offset}$ ).
<u>Address \$0x45</u>			
7:4		RW	Reserved. Set these bits Low. Undefined on read.
3:0	<i>TxIOffsetMSB</i>	Data RW	Most significant 4 bits of the TxIOffset register ( $N_{offset}$ ).
<u>Address \$0x4A</u>			
7:0	<i>TxQOffsetLSB</i>	Data RW	Least significant 8 bits of the TxQOffset register ( $N_{offset}$ ).
<u>Address \$0x4B</u>			
7:4		RW	Reserved. Set these bits Low. Undefined on read.
3:0	<i>TxQOffsetMSB</i>	Data RW	Most significant 4 bits of the TxQOffset register ( $N_{offset}$ ).

- **Address and Data format for TxIOffset access**

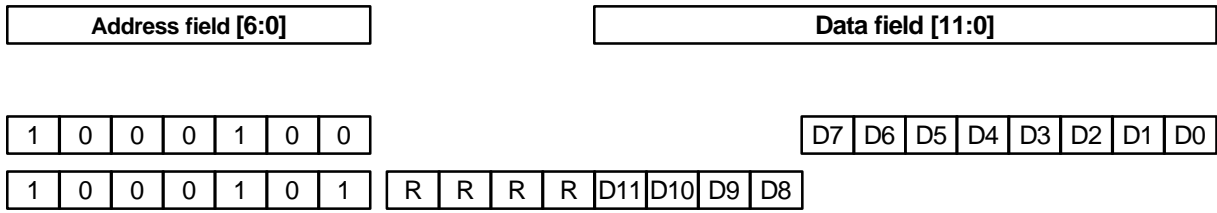

- **Address and Data format for TxQOffset access**

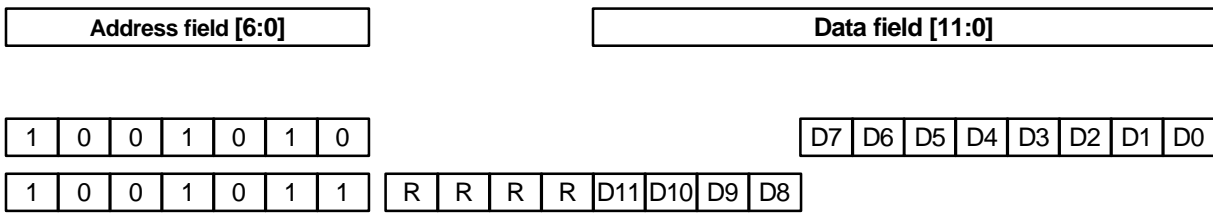

**TxPhase**

Title: Transmit I and Q channel Phase correction register

Address: \$0x40, \$0x41, \$0x46, \$0x47 (4 locations)

Function: RW

Description: This register controls the Tx Data path I and Q channel phase compensation. The phase may be adjusted by  $\pm 7.1^\circ$  with respect to the input data signal phase. As each channel has separate phase adjustments the maximum differential phase compensation that can be achieved is  $\pm 14.2^\circ$ . The phase adjustment value written to this register is a 2s-complement value ( $N_{phase}$ ).

The amount of phase adjustment applied is given by the formula:

$$\phi = \tan^{-1} \left[ \frac{N_{phase}}{2^{II}} \right]$$

Where:  $\phi$  is the phase adjustment,  
 $N_{phase}$  is the value in the register and has a range of -256 to +255.

Note: Although each channel is separately adjustable with its own compensation value, the effect of phase adjustment is only detectable by measuring the phase angle between I and Q channels. It should be noted that the  $N_{phase}$  value has the effect of lagging the I channel for positive values of  $N_{phase}$  (conversely, leading the phase for negative values) and leading the Q channel for positive values of  $N_{phase}$  (conversely, lagging the phase for negative values). For example, putting the value 10 (decimal) into both TxIPhase and TxQPhase would produce a differential phase on I and Q of:

$$90^\circ - 2(\tan^{-1}(4.88 \times 10^{-3})) = 89.44^\circ$$

Bit	Name	Active State	Function
<u>Address \$0x40</u>			
7:0	TxIPhaseLSB	Data RW	Least significant 8 bits of the TxIPhase register ( $N_{phase}$ ).
<u>Address \$0x41</u>			
7:1		RW	Reserved. Set these bits Low. Undefined on read.
0	TxIPhaseMSB	Data RW	Most significant bit of the TxIPhase register (sign bit).
<u>Address \$0x46</u>			
7:0	TxQPhaseLSB	Data RW	Least significant 8 bits of the TxQPhase register ( $N_{phase}$ ).
<u>Address \$0x47</u>			
7:1		RW	Reserved. Set these bits Low. Undefined on read.
0	TxQPhaseMSB	Data RW	Most significant bit of the TxQPhase register (sign bit).

- **Address and Data format for TxIPhase access**

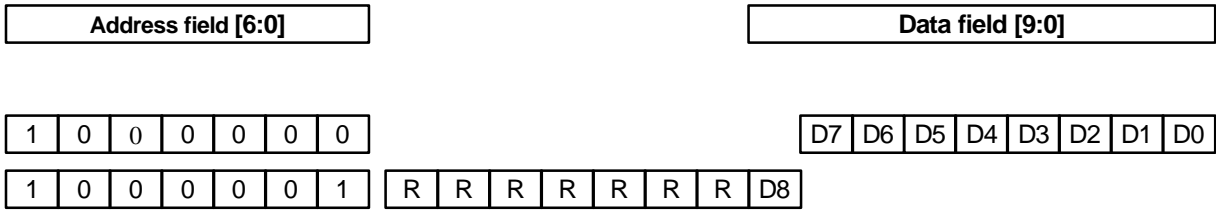

- **Address and Data format for TxQPhase access**

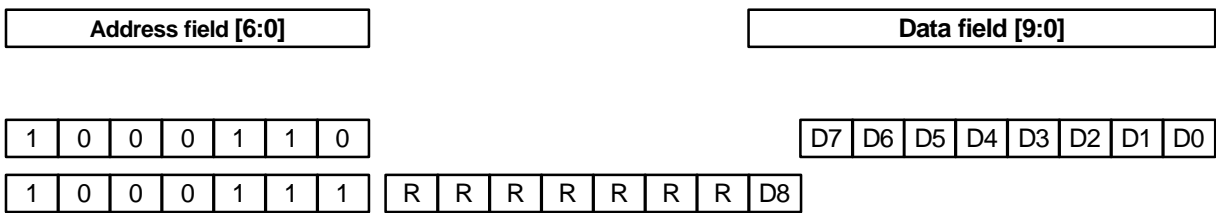

**TxDataAccess**

Title: Tx Data path Access point.

Address: \$0x50 to \$0x53 (mapped over 4 locations)

Function: RW

Description: This register block allows direct access to the Tx Data path values just after the gain, phase and offset adjustment block. Both read and write operations are permitted. A read operation reads the signal values on the I and Q channels. A write operation will write data to the data path just before the 15-tap filter. To prevent normal Tx data overwriting this value the *TxDPAccessSel* bit in the **LoopBackCtrl** register should be set active. The MSB read data register is buffered to enable access to a discrete sample value (if this register was not buffered, data from different sample periods could be in the MSB and LSB registers). Therefore the LSB register must be read first for correct operation.

Bit	Name	Active State	Function
<u>Address \$0x50</u>			
7:0	<i>TxDPIDataLSB</i>	Data RW	Least significant 8 bits of the TxDPIData register. This register must be read before its associated MSB register.
<u>Address \$0x51</u>			
7:4		RW	Reserved. Set these bits Low. Undefined on read.
3:0	<i>TxDPIDataMSB</i>	Data RW	Most significant 2 bits of the TxDPIData register.
<u>Address \$0x52</u>			
7:0	<i>TxDPQDataLSB</i>	Data RW	Least significant 8 bits of the TxDPQData register. This register must be read before its associated MSB register.
<u>Address \$0x53</u>			
7:4		RW	Reserved. Set these bits Low. Undefined on read.
3:0	<i>TxDPQDataMSB</i>	Data RW	Most significant 2 bits of the TxDPQData register.

- **Address and Data format for TxDPIData access**

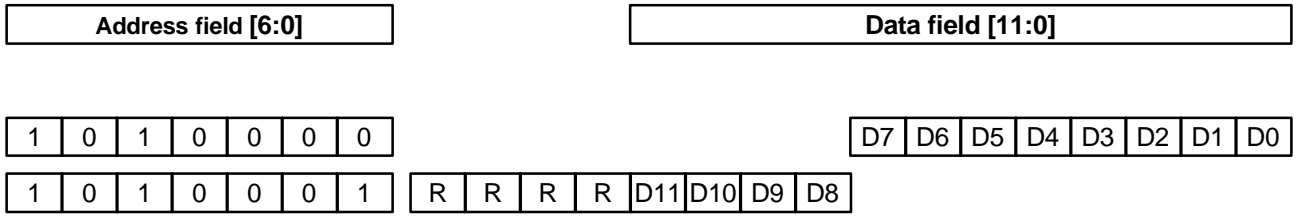

- **Address and Data format for TxDPQData access**

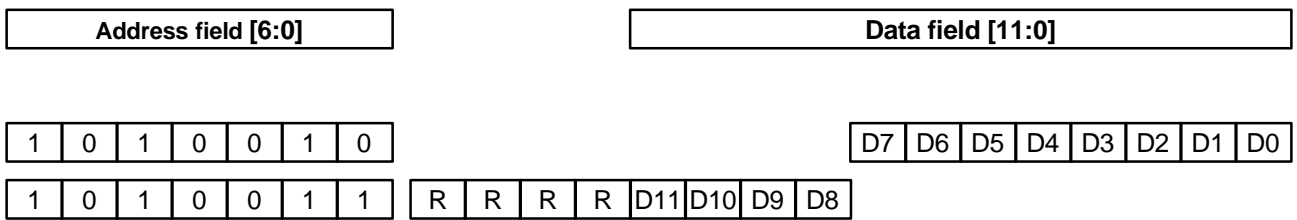

**RxIQGainMult**

Title: Receive I and Q channel Gain Multiplier register

Address: \$0x30, \$0x31, \$0x34 and \$0x35 (4 locations)

Function: RW

Description: A 2s-complement multiplication is performed on the magnitude of the Rx Data path signal and the result is then re-normalised to the system's dynamic range: thus the function may be considered as a digital attenuator. This multiplication is applied to the Rx signal after the ADC decimation filter, but before offset adjustment and the 63-tap and 49-tap FIR filters. This register sets the multiplier, the result being given by the formula:

$$D_{out} = D_{in} \left[ \frac{G_{val}}{2^{15}} \right]$$

Where:  $D_{in}$  is the signal input,  
 $D_{out}$  is the signal output,  
 $G_{val}$  is the value in the register.

Bit	Name	Active State	Function
<u>Address \$0x30</u>			
7:0	<i>RxIGainLSB</i>	Data RW	Least significant 8 bits of the RxIGain register ( $G_{val}$ ).
<u>Address \$0x31</u>			
7:3		RW	Reserved. Set these bits Low. Undefined on read.
2:0	<i>RxIGainMSB</i>	Data RW	Most significant 3 bits of the RxIGain register ( $G_{val}$ ).
<u>Address \$0x34</u>			
7:0	<i>RxQGainLSB</i>	Data RW	Least significant 8 bits of the RxQGain register ( $G_{val}$ ).
<u>Address \$0x35</u>			
7:3		RW	Reserved. Set these bits Low. Undefined on read.
2:0	<i>RxQGainMSB</i>	Data RW	Most significant 3 bits of the RxQGain register ( $G_{val}$ ).

- **Address and Data format for RxIGain access**

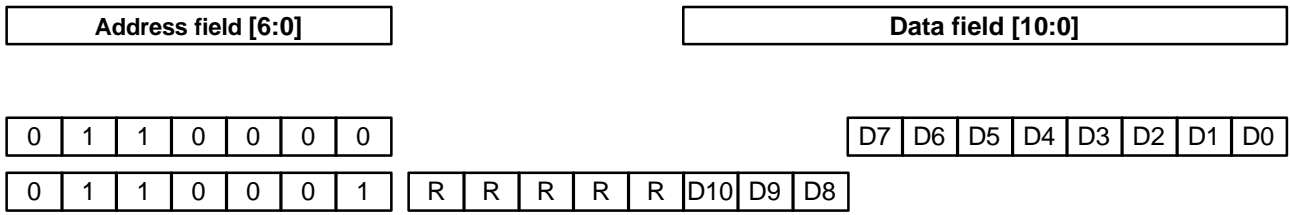

- **Address and Data format for RxQGain access**

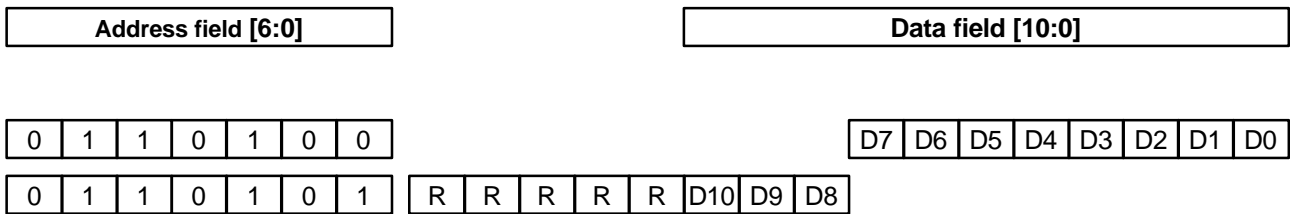



**RxIQOffset**

Title: Receive I and Q Channel Offset correction register

Address: \$0x32, \$0x33, \$0x36, and \$0x37 (4 locations)

Function: RW

Description: This register controls the Rx Data path signal offset. This offset is a 2s-complement value ( $N_{offset}$ ), which is applied to the Rx signal after the Gain Multiplier ( $G_{val}$ ), but before the 63-tap and 49-tap FIR filters. The offset applied is at the discretion of the user. Inappropriate values may cause arithmetic overflow in the subsequent operator sections. The result is given by the formula:

$$D_{out} = D_{in} + \left[ \frac{N_{offset}}{2^{15}} \right]$$

Where:  $D_{in}$  is the signal input,  
 $D_{out}$  is the signal output,  
 $N_{offset}$  is the 2s-complement value in the register.

Bit	Name	Active State	Function
<u>Address \$0x32</u>			
7:0	RxIOffsetLSB	Data RW	Least significant 8 bits of the RxIOffset register ( $N_{offset}$ ).
<u>Address \$0x33</u>			
7:4		RW	Reserved. Set these bits Low. Undefined on read.
3:0	RxIOffsetMSB	Data RW	Most significant 4 bits of the RxIOffset register ( $N_{offset}$ ).
<u>Address \$0x36</u>			
7:0	RxQOffsetLSB	Data RW	Least significant 8 bits of the RxQOffset register ( $N_{offset}$ ).
<u>Address \$0x37</u>			
7:4		RW	Reserved. Set these bits Low. Undefined on read.
3:0	RxQOffsetMSB	Data RW	Most significant 4 bits of the RxQOffset register ( $N_{offset}$ ).

- **Address and Data format for RxIOffset access**

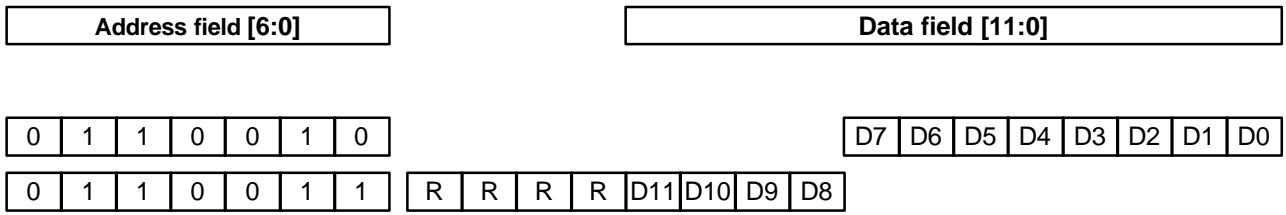

- **Address and Data format for RxQOffset access**

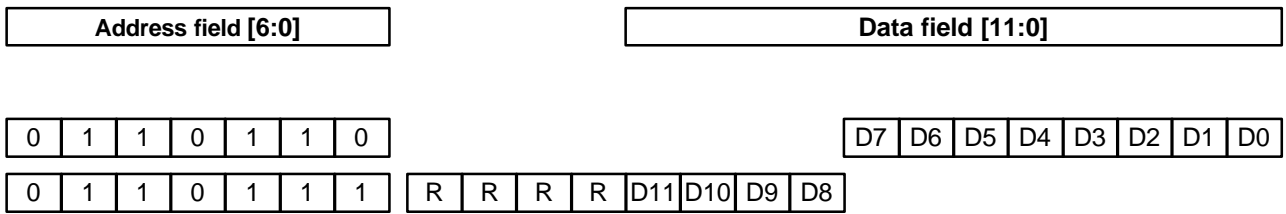

**RxDataAccess**

Title: Rx Data path Access point.

Address: \$0x38 to \$0x3B (mapped over 4 locations)

Function: RW

Description: This register block allows direct access to the Rx Data path values just after the 59-tap (Rx anti-alias) filter. Both read and write operations are permitted. A read operation reads the signal values on the I and Q channels. A write operation will write data to the Rx Data path operator output. To prevent normal Rx data overwriting this value the *RxDPAccessSel* bit in the **LoopBackCtrl** register should be set active. The MSB read data register is buffered to enable access of a discrete sample value (if this register was not buffered, data from different sample periods could be in the MSB and LSB registers). Therefore the LSB register must be read first for correct operation.

Bit	Name	Active State	Function
<u>Address \$0x38</u>			
7:0	<i>RxDPIDataLSB</i>	Data RW	Least significant 8 bits of the RxDPIData register. This register must be read before its associated MSB register.
<u>Address \$0x39</u>			
7:0	<i>RxDPIDataMSB</i>	Data RW	Most significant 8 bits of the RxDPIData register.
<u>Address \$0x3A</u>			
7:0	<i>RxDPQDataLSB</i>	Data RW	Least significant 8 bits of the RxDPQData register. This register must be read before its associated MSB register.
<u>Address \$0x3B</u>			
7:0	<i>RxDPQDataMSB</i>	Data RW	Most significant 8 bits of the RxDPQData register.

• **Address and Data format for RxDPIData access**

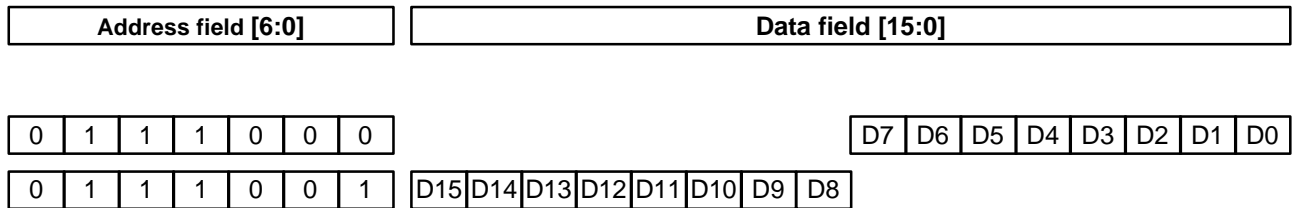

• **Address and Data format for RxDPQData access**

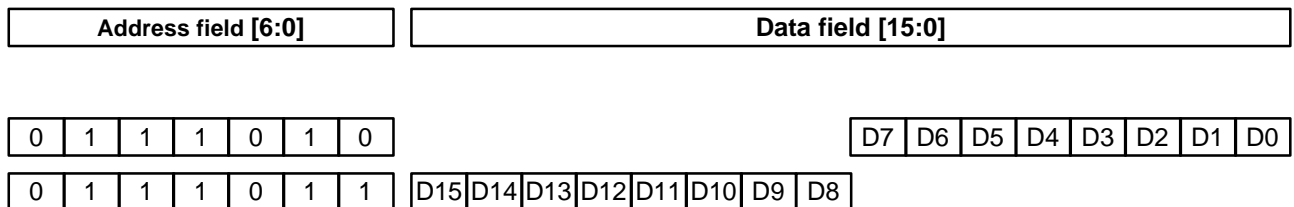

**BISTControl**

Title: Built In Self Test Control register

Address: \$0x62

Function: RW

Description: This register block allows control of BIST operations.

Bit	Name	Active State	Function
7	<i>TestCompleteAck</i>	High/ RW Low	This bit is set by the user and cleared by the BIST controller when a BIST cycle has been completed.
6	<i>n_RampDelayEn</i>	Low RW	Allow Ramp control signal delay. This delay is required for normal operations, by matching the FIR filter delays. For BIST operations it can be disabled thus reducing BIST test time.
5	<i>BISTDataRateHi</i>	High RW	Selects BIST data rate = 2.34 MHz Default rate (Low) = 1.44 kHz
4	<i>BISTEn</i>	High RW	Enables BIST operations.
3	<i>ContinuousBIST</i>	High RW	Selects continuous BIST mode. Default (Low) selects single cycle mode.
2	<i>EnRxDigitalFeedBack</i>	High RW	Selects Rx digital loop feedback for 49-tap Tx FIR input data. Default (Low) selects normal Tx data.
1	<i>En49tIQData</i>	High RW	Selects BIST data for 49-tap Tx FIR filter input. Default (Low) selects normal data.
0	<i>EnSymTestData</i>	High RW	Selects BIST data for 79-tap FIR filter input. Default (Low) selects normal data.

• **Address and Data format for BistControl access**

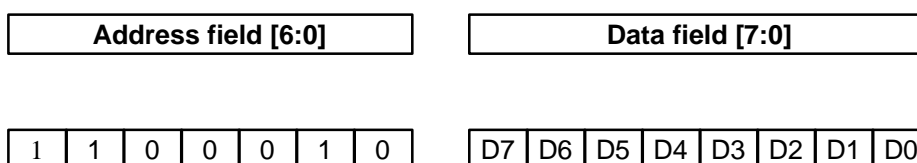

**BISTPRSG**

Title: Built In Self Test Pseudo Random Sequence Generator

Address: \$0x60 to \$0x61 (2 locations)

Function: RW

Description: This register block allows control of BIST operations. This 16-bit number controls the length of the BIST data sequence. It is the initial value (or seed) written to the pseudo-random sequence generation logic. The length of the BIST data sequence is a function of the feedback logic equation and this initial value. The feedback function is fixed so run lengths are therefore controlled by this value.

Which values to apply to give specific run lengths can be determined from a look-up table. This table may be provided on request.

Bit	Name	Active State	Function
<u>Address \$0x60</u>			
7:0	<i>BISTPRSGLSB</i>	Data RW	Least significant 8 bits of the BISTPRSG register. This register must be read before its associated MSB register.
<u>Address \$0x61</u>			
7:0	<i>BISTPRSGMSB</i>	Data RW	Most significant 8 bits of the BISTPRSG register. This register must be read after its associated LSB register.

• **Address and Data format for BISTPRSG access**

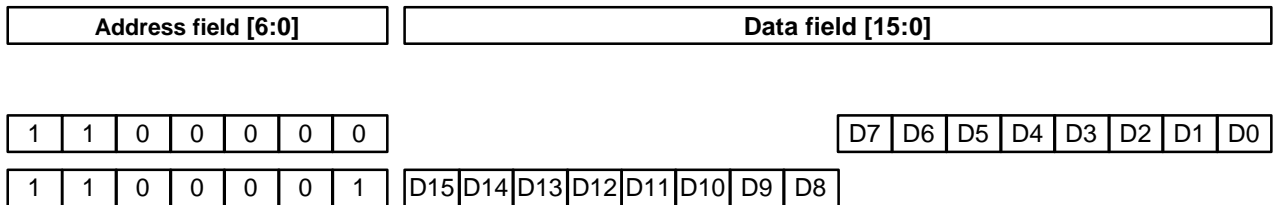

**BISTCRCRegisters**

Title: Built In Self Test Cyclic Redundancy Code checking Registers

Address: \$0x64 to \$0x6D (10 locations)

Function: RW

Description: This register block allows BIST CRC checksums to be read.

Bit	Name	Active State	Function
<u>Address \$0x64</u>			
7:0	<i>79tapI_CRCLSB</i>	Data RW	Transmit I channel 79-tap filter LSB register.
<u>Address \$0x65</u>			
7:0	<i>79tapI_CRCMSB</i>	Data RW	Transmit I channel 79-tap filter MSB register.
<u>Address \$0x66</u>			
7:0	<i>79tapQ_CRCLSB</i>	Data RW	Transmit Q channel 79-tap filter LSB register.
<u>Address \$0x67</u>			
7:0	<i>79tapQ_CRCMSB</i>	Data RW	Transmit Q channel 79-tap filter MSB register
<u>Address \$0x68</u>			
7:0	<i>SDM_CRCLSB</i>	Data RW	Transmit SDM DAC LSB register.
<u>Address \$0x69</u>			
7:0	<i>SDM_CRCMSB</i>	Data RW	Transmit SDM DAC MSB register.
<u>Address \$0x6A</u>			
7:0	<i>RXI_CRCLSB</i>	Data RW	Receive I channel LSB register.
<u>Address \$0x6B</u>			
7:0	<i>RXQ_CRCLSB</i>	Data RW	Receive I channel MSB register.
<u>Address \$0x6C</u>			
7:0	<i>RXQ_CRCLSB</i>	Data RW	Receive Q channel LSB register.
<u>Address \$0x6D</u>			
7:0	<i>RXQ_CRCMSB</i>	Data RW	Receive Q channel MSB register.

- Address and Data format for 79-tap I channel CRC reg access

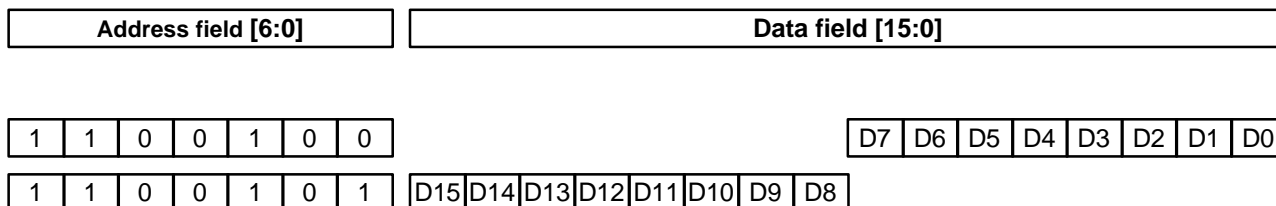

- Address and Data format for 79-tap Q channel CRC reg access

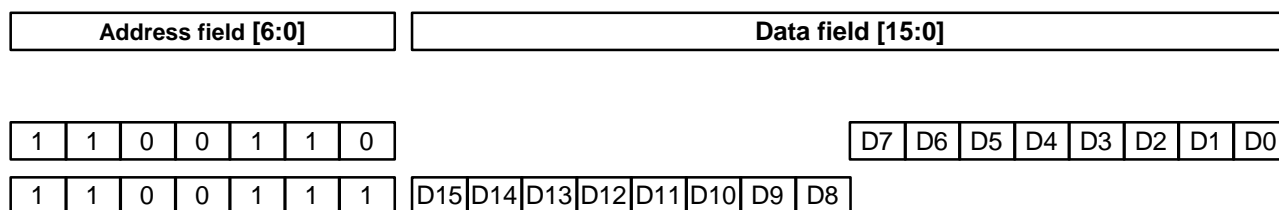

- Address and Data format for SDM CRC reg access

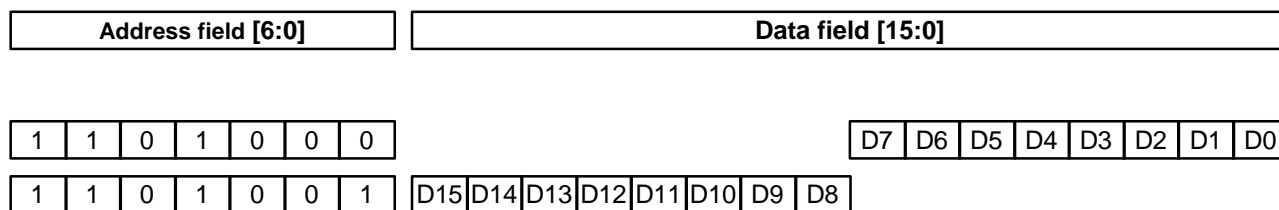

- Address and Data format for RX I Channel CRC reg access

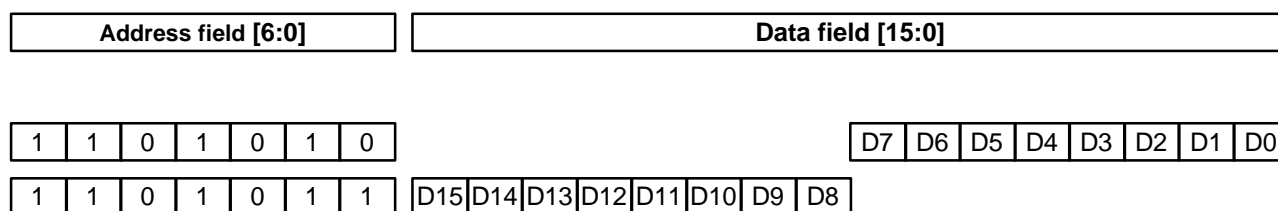

- Address and Data format for RX Q Channel CRC reg access

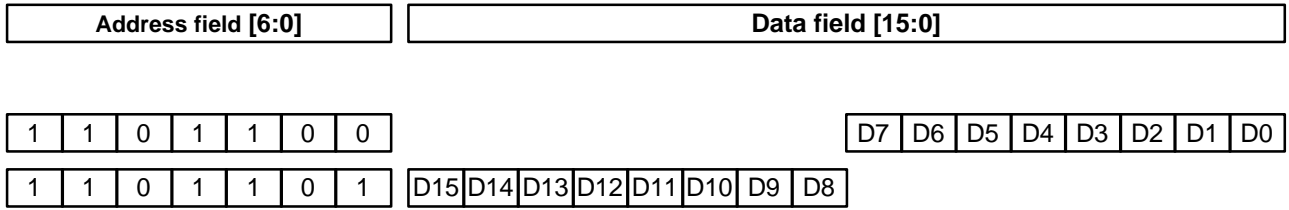



## **1.6 Application Notes**

TBD

### **1.6.1 General**

### **1.6.2 Transmitter**

### **1.6.3 Receiver**

### **1.6.4 Timing**

## 1.7 Performance Specification

### 1.7.1 Electrical Performance

#### Absolute Maximum Ratings

Exceeding these maximum ratings can result in damage to the device.

	Min.	Max.	Units
Supply			
$V_{DD} - V_{SS}$	-0.3	7.0	V
$V_{CC1} - V_{SS1}$	-0.3	7.0	V
$V_{CC2} - V_{SS2}$	-0.3	7.0	V
$V_{CC3} - V_{SSB}$	-0.3	7.0	V
$V_{DD1} - V_{SSA}$	-0.3	7.0	V
Voltage on any pin to $V_{SS}$	-0.3	$V_{DD} + 0.3$	V
Voltage on any pin to $V_{SS1}$	-0.3	$V_{CC1} + 0.3$	V
Voltage on any pin to $V_{SS2}$	-0.3	$V_{CC2} + 0.3$	V
Voltage on any pin to $V_{SSA}$	-0.3	$V_{DD1} + 0.3$	V
Voltage on any pin to $V_{SSB}$	-0.3	$V_{CC3} + 0.3$	V
Current into or out of $V_{DD}$ , $V_{CC1}$ , $V_{CC2}$ , $V_{CC3}$ , $V_{DD1}$ , $V_{SS}$ , $V_{SS1}$ , $V_{SS2}$ , $V_{SSB}$ and $V_{SSA}$	-30	+30	mA
Current into or out of any other pin	-20	+20	mA
Voltage differential between power supplies ( $V_{DD}$ , $V_{CC1}$ , $V_{CC2}$ , $V_{CC3}$ and $V_{DD1}$ )	0	0.3	V
( $V_{SS}$ , $V_{SS1}$ , $V_{SS2}$ , $V_{SSB}$ and $V_{SSA}$ )	0	50	mV

L6 Package	Min.	Max.	Units
Total Allowable Power Dissipation at $T_{amb} = 25^{\circ}\text{C}$		800	mW
... Derating		13	mW/ $^{\circ}\text{C}$
Storage Temperature	-55	+125	$^{\circ}\text{C}$
Operating Temperature	-40	+85	$^{\circ}\text{C}$

# Package	Min.	Max.	Units
Total Allowable Power Dissipation at $T_{amb} = 25^{\circ}\text{C}$		550	mW
... Derating		9	mW/ $^{\circ}\text{C}$
Storage Temperature	-55	+125	$^{\circ}\text{C}$
Operating Temperature	-40	+85	$^{\circ}\text{C}$

#### Operating Limits

Correct operation of the device outside these limits is not implied.

	Notes	Min.	Max.	Units
Supply				
$V_{DD} - V_{SS}$		4.5	5.5	V
$V_{CC1} - V_{SS1}$		4.5	5.5	V
$V_{CC2} - V_{SS2}$		4.5	5.5	V
$V_{CC3} - V_{SSB}$		4.5	5.5	V
$V_{DD1} - V_{SSA}$		4.5	5.5	V
Operating Temperature		-40	+85	$^{\circ}\text{C}$
MCLK Frequency		TBD	TBD	MHz

## Operating Characteristics

For the following conditions unless otherwise specified:

MCLK Frequency = 9.216MHz, Symbol Rate = 18k bits/sec,  
 $(V_{DD} - V_{SS}) = (V_{CC1} - V_{SS1}) = (V_{CC2} - V_{SS2}) = (V_{CC3} - V_{SSB}) = (V_{DD1} - V_{SSA}) = 3.0V$  to 3.6V for 3.3V parameters, 4.5V to 5.5V, for 5.0V parameters.  $T_{amb} = -40^{\circ}C$  to  $+85^{\circ}C$ .

At 5V, *Bias/Ctrl* = 0 and at 3.3V *Bias/Ctrl* = 1 in **PowerDownCtrl** register will optimise the analogue performance in the Tx and Rx sections.

It is assumed that all powersave and clock stop bits are set, where appropriate.

	Notes	Min.	Typ.	Max.	Units
<b>5V DC Parameters (MCLK not toggled)</b>					
I <sub>DD</sub> (Tx powersaved)	1		20		mA
I <sub>DD</sub> (Rx powersaved)	1		20		mA
I <sub>DD</sub> (Aux powersaved)	1		34		mA
I <sub>DD</sub> (All powersaved)	1		<0.05		mA
I <sub>DD</sub> (Not powersaved)	1		36		mA
<b>5V AC Parameters (MCLK at 9.216MHz)</b>					
I <sub>DD</sub> (Tx powersaved)	1		40		mA
I <sub>DD</sub> (Rx powersaved)	1		35		mA
I <sub>DD</sub> (Aux powersaved)	1		62		mA
I <sub>DD</sub> (All powersaved)	1		12		mA
I <sub>DD</sub> (Not powersaved)	1		64		mA
<b>3.3V DC Parameters (MCLK not toggled)</b>					
I <sub>DD</sub> (Tx powersaved)	1		18		mA
I <sub>DD</sub> (Rx powersaved)	1		18		mA
I <sub>DD</sub> (Aux powersaved)	1		31		mA
I <sub>DD</sub> (All powersaved)	1		<0.05		mA
I <sub>DD</sub> (Not powersaved)	1		32		mA
<b>3.3V AC Parameters (MCLK at 9.216MHz)</b>					
I <sub>DD</sub> (Tx powersaved)	1		31		mA
I <sub>DD</sub> (Rx powersaved)	1		33		mA
I <sub>DD</sub> (Aux powersaved)	1		48		mA
I <sub>DD</sub> (All powersaved)	1		7.5		mA
I <sub>DD</sub> (Not powersaved)	1		49		mA
<b>MCLK Input</b>					
'High' pulse width	3	40			ns
'Low' pulse width	3	40			ns
Input impedance (at 100Hz)		10			MΩ

- Notes:**
1. Not including any current drawn from the device pins by external circuitry.
  3. Timing for an external input to the MCLK pin.

**Transmit Parameters**

Parameter	Typ	Units	Conditions/Comments
Input bit rate	36	kbps	2 bits/symbol
No. of channels	2		I and Q
Modulation type	$\pi/4$ DQPSK		
RRC Roll-off coefficient (a)	0.35		
H(f)  0 - 5.85kHz	0 $\pm$ 0.3	dB	0 dB corresponds to 1V pk-pk
H(f)  @ 9kHz	-3 $\pm$ 0.3	dB	
H(f)  @ 10.05kHz	-6 $\pm$ 1	dB	
H(f)  @ 12.15kHz	< -30	dB	
Max spuri @ 16kHz	-60	dBc	Relative to maximum passband signal level
@ 25kHz	-68	dBc	
@ 50kHz	-78	dBc	
@ 75kHz	-80	dBc	
FIR filter sampling rate	144	kHz	
DAC output update rate	2.304	MHz	
DAC resolution	12	Bits	
Integral accuracy	< $\pm$ 0.5	LSB	
Differential accuracy	< $\pm$ 0.25	LSB	
Offset	< 25	mV	Without adjustment
Gain matching, I to Q	< $\pm$ 0.3dB	dB	Without adjustment
Gain matching, (I or Q) to ideal Tx	< $\pm$ 0.3	dB	Normalised, 0 - 9kHz
Phase matching, I to Q	< $\pm$ 0.5	Degrees	After adjustment, 0 - 9kHz
Storage time	< 18	Symbols	
Active Power	<105	mW	3.3V, Rx, aux powered down
Vector Error (rms., typical)	0.017		Vector errors measured with ideal IF and RF sections after gain and offset adjustment, and specified as a fraction of the nominal vector value.
Vector Error (rms., max)	0.025		
Vector Error (peak, typical)	0.045		
Vector Error (peak, max)	0.07		
I,Q output level VCC = 5.0V	2.5	V	Peak to peak, differential at maximum gain
VCC = 3.3V	1.65	V	

**Notes:**

All parameters refer to the entire Tx baseband I and Q channels, unless otherwise indicated.

A gain multiplier function allows independent proportional control of each channel. The multiplier is a 12-bit word for each channel, input via the serial interface, representing a value from 0 to 1. This multiplication is applied to the signals from the FIR filters.

Offset adjustment for each channel is available by loading a 12-bit word into the transmit offset register via the serial interface.

## Receive Parameters

Parameter	Typ	Units	Conditions/Comments
Input impedance	<10 > 100	pF k $\Omega$	Capacitive load to V <sub>SS1</sub> or V <sub>SS2</sub> Source should be < 1000 $\Omega$
Differential Input voltage range VCC=5.0V VCC=3.3V	2.8 1.8	V pk-pk (Typ)	Note this means $\pm 0.7V$ or $\pm 0.45V$ on each input of the differential pair.
3rd order intercept	TBD		
With internal anti-alias filter disabled:- Anti -alias requirements @ 130kHz @ 2.3MHz	<-30 <-120	dB dB	w.r.t. max. input level w.r.t. max. input level
ADC sampling rate	2.304	MHz	
ADC resolution	16	Bits	
Integral accuracy	< $\pm 1$	LSB	
Differential accuracy	< $\pm 1$	LSB	
RRC Roll-off coefficient (a)	0.35		
H(f)  0 - 5.85kHz	0 $\pm 0.2$	dB	0 dB corresponds to 1V pk-pk
H(f)  @ 9kHz	-3 $\pm 0.2$	dB	
H(f)  @ 10.05kHz	-6 $\pm 1$	dB	
H(f)  @ 12.15kHz	< -30	dB	
H(f)  @ 16kHz	< -70	dB	
H(f)  @ 25kHz	< -70	dB	
H(f)  @ 50kHz	< -80	dB	
H(f)  @ 75kHz	< -90	dB	
FIR filter sampling rate	2.304	MHz	Decimation sections
	144	kHz	RRC sections
Output rate (16 bit words per channel) - selectable	144 or 72	kHz kHz	Output via the serial interface at 4.608 MHz or 2.304MHz
Offset	< 10	mV	Without adjustment
Gain matching, I to Q	< $\pm 0.1$	dB	Without adjustment, 0 -10kHz
Phase matching, I to Q	< $\pm 0.5$	Degrees	0 - 10kHz
Storage time	< 15	Symbols	
Active Power	<100	mW	3.3V power supply
With internal anti-alias filter enabled:- Anti -alias requirements @ 130kHz @ 2.3MHz	<-30 <-30	dB dB	Use network shown in Figure 2 w.r.t. max. input level
Active Power	<110	mW	

**Notes:**

Offset adjustment for each channel is available by loading a 16-bit word into the receive offset register via the serial interface.

Optimally, anti-alias filtering should be carried out as much as possible prior to any AGC function before the receive inputs. This allows the AGC to act on a reduced bandwidth signal and thereby improve the relative magnitude of the wanted part. The device has been designed to reduce the complexity of any external anti-alias filter as much as possible and a 4-pole Butterworth with a -3dB point at about 60kHz should be adequate. The internal anti-alias filter, if used, cannot provide the required 110dB attenuation at 2.3MHz and must be supplemented by external filtering. The most simple supplementary system may be a one- or two-pole filter before the AGC and an RC network after the AGC with a -3dB point on each filter of about 200kHz.

**Auxiliary Circuit Parameters**

Parameter	Typ	Units	Conditions/comments
<u>DACs</u>			
Resolution	10	Bits	Worst case large signal transition
Settling time to 0.5 LSB	<10	µSec	
Output resistance	<250	Ω	Guaranteed Monotonic
Integral non-linearity	<4	Bits	
Differential non-linearity	<1	Bit	
Zero error (offset)	±20	mV	
Power (all DACs operating)	<10	mW	
Minimum Resistive Load	5	kΩ	
RMS output noise voltage in 30kHz bandwidth	10	µV	
<u>ADC and Multiplexed inputs</u>			
Maximum input source impedance	25	kΩ	Gives < 1 bit error
Resolution	10	Bits	
Maximum input signal "linear rate of change" for < 1 bit error	0.27	mV/µs	
Conversion time	12	µSec	No missing codes
Integral non-linearity	<2	Bits	
Differential non-linearity	<1	Bit	
Zero error (offset)	±20	mV	
A-D Clock frequency	MCLK/8	(Hz)	
Input capacitance	<5	pF	
Power	<3	mW	

1.7.1. Electrical Performance

Timing Diagrams

The following timings are provisional:

1.7.1.1 Serial Ports

Timing Parameter	Marker	Min	Max	Units
MCLK to SClk out - low to high	$t_{cslh}$	15	50	ns
MCLK to SClk out - high to low	$t_{cshl}$	10	35	ns
CmdDat set-up to falling edge of SCIk	$t_{sis}$	35		ns
CmdFS set-up to falling edge of SCIk	$t_{sis}$	35		ns
CmdDat hold from fall edge of SCIk	$t_{sih}$		0	ns
CmdFS hold from fall edge of SCIk	$t_{sih}$		0	ns
RxDat propagation from rising edge of SCIk	$t_{sop}$		5	ns
RxFS propagation from rising edge of SCIk	$t_{sop}$		5	ns
CmdRdDat propagation from rising edge of SCIk	$t_{sop}$		5	ns
CmdRdFS propagation from rising edge of SCIk	$t_{sop}$		5	ns
RxDat hold from rising edge of SCIk	$t_{soh}$	-5		ns
RxFS hold from rising edge of SCIk	$t_{soh}$	-5		ns
CmdRdDat hold from rising edge of SCIk	$t_{soh}$	-5		ns
CmdRdFS hold from rising edge of SCIk	$t_{soh}$	-5		ns
**Cmd port in Bi-dir mode **				
CmdDat propagation from rising edge of SCIk	$t_{sop}$		7	ns
CmdDat hold from rising edge of SCIk	$t_{soh}$	-7		ns

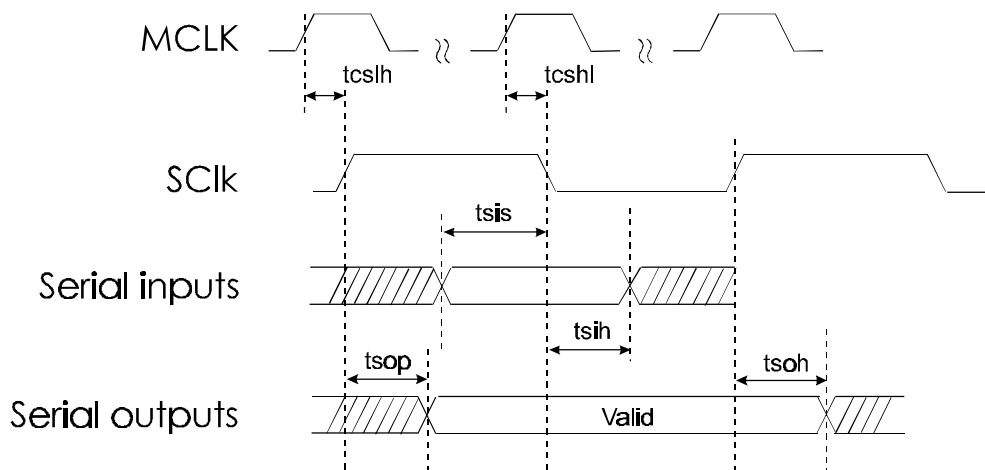

Figure 4 Serial Port Interfaces - Timing Parameters

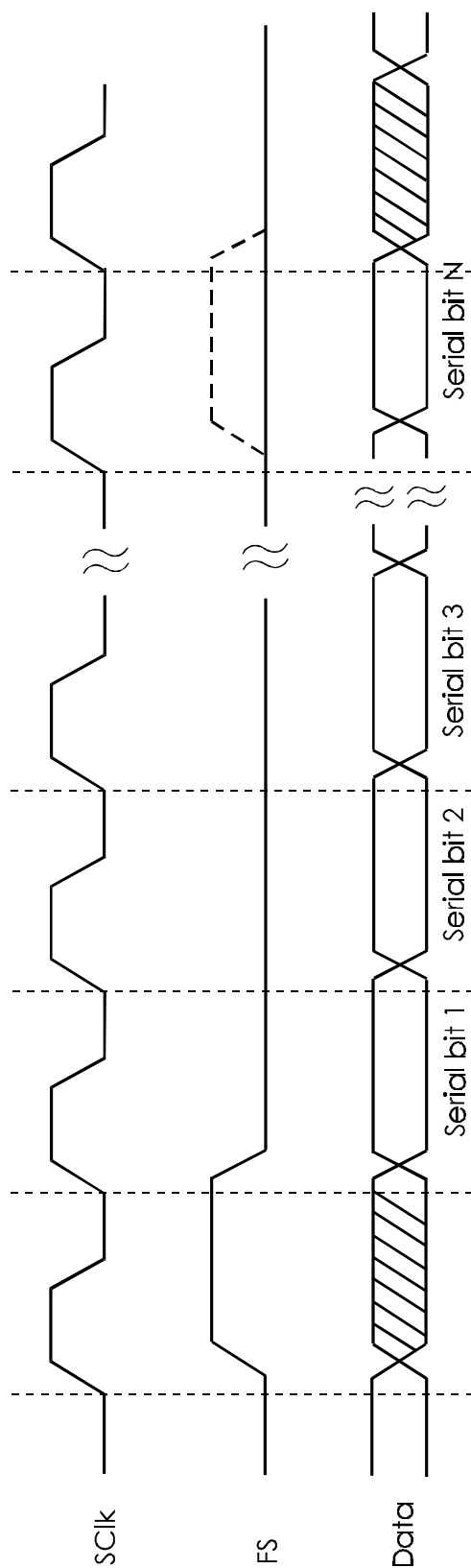

Figure 5a Basic Serial Port Signals



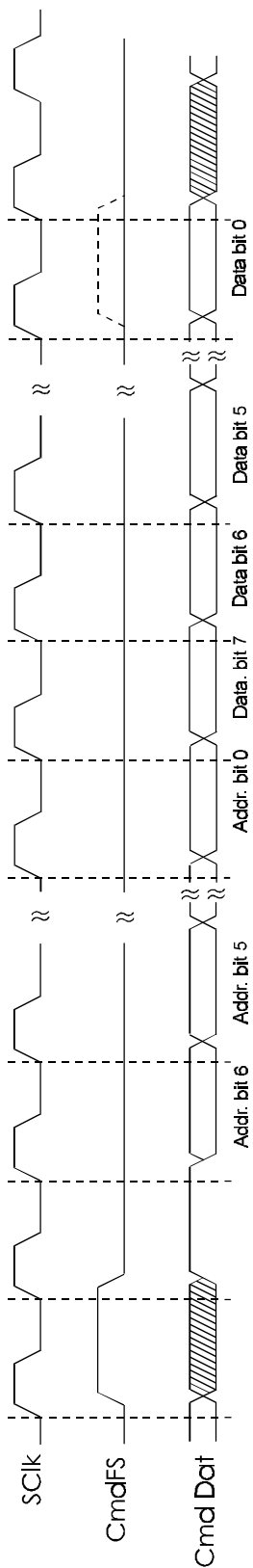

Figure 5b Command Write operation

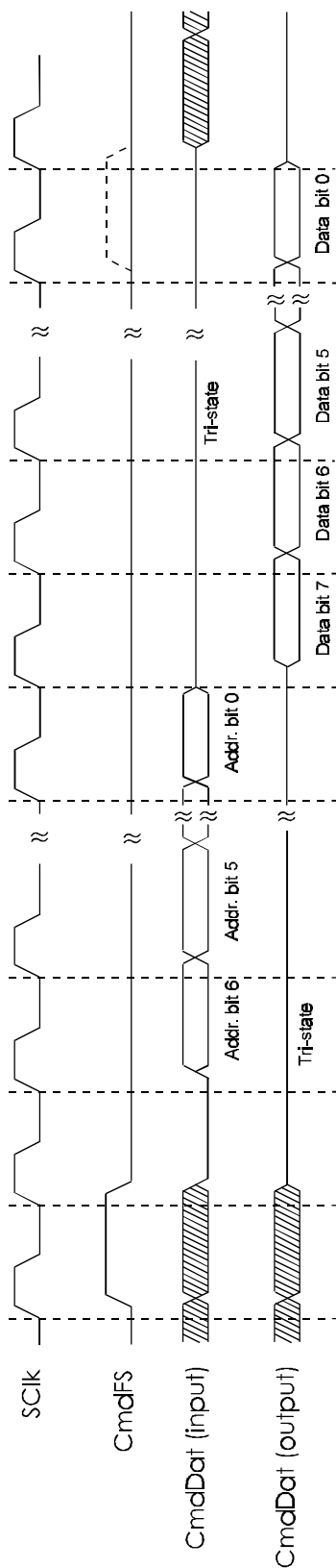

Figure 5c Bi-dir Command Read Operation

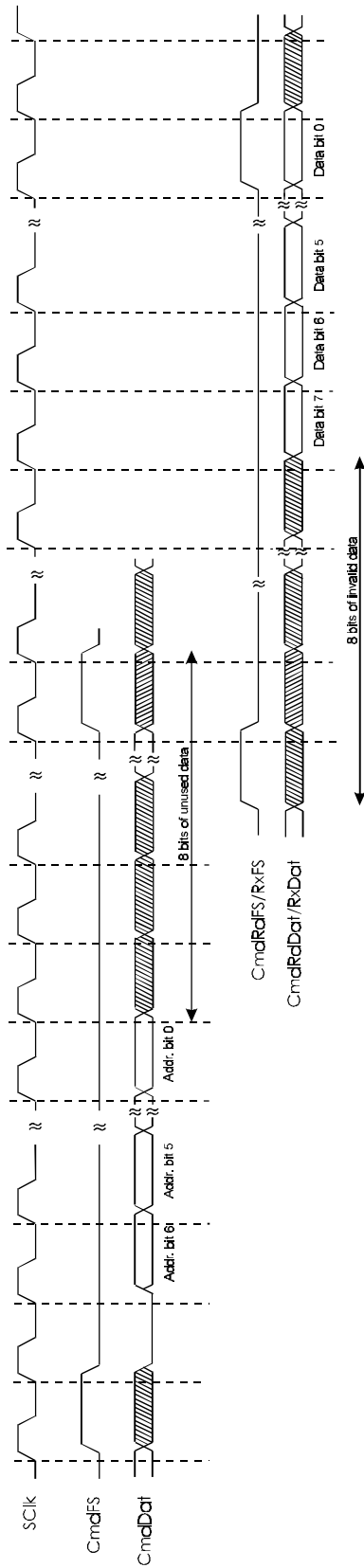

Figure 5d Non bi-dir Command Read Operation

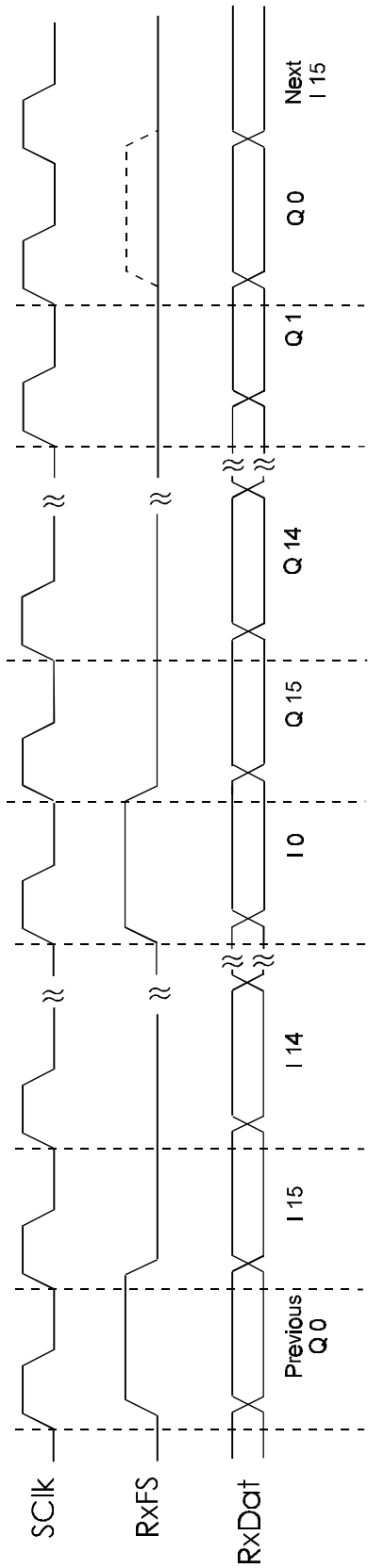

Figure 5e Rx Data Serial Port Read Operation

1.7.2 Packaging

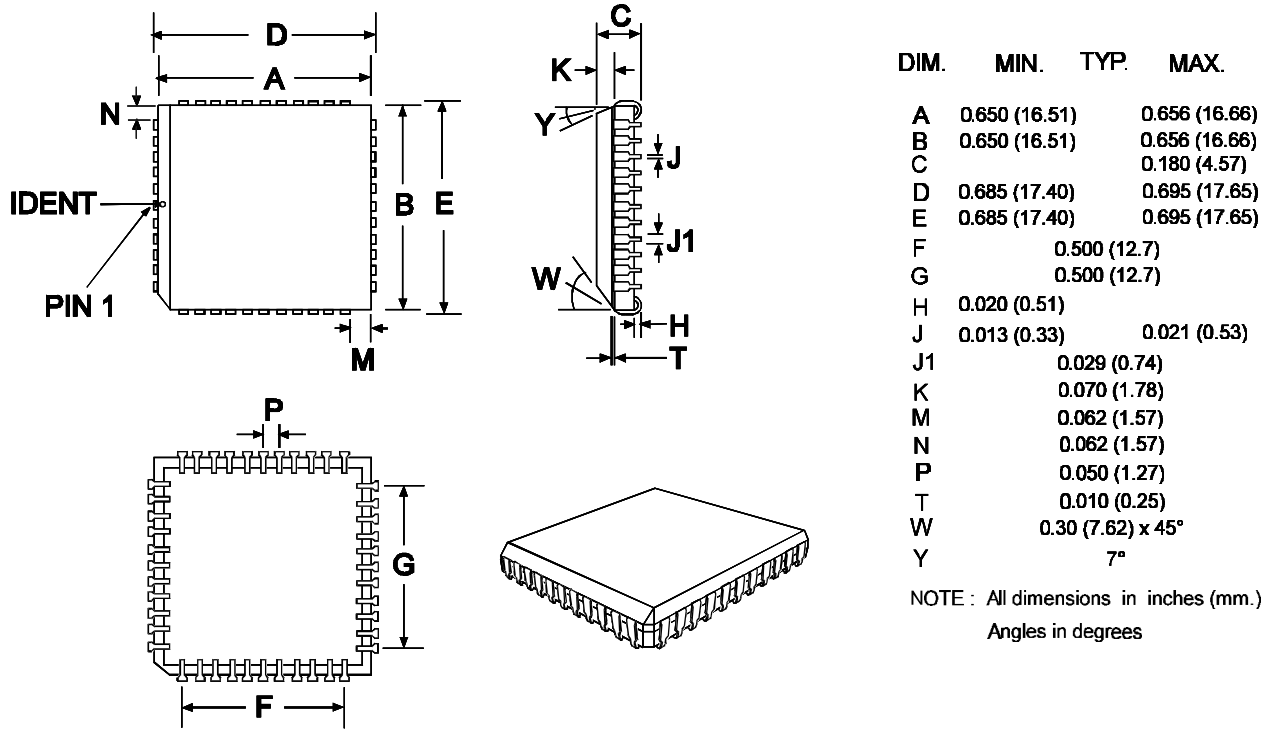

Figure 6 L6 Mechanical Outline: Order as part no. FX980L6

Figure 7 FX980L7 Mechanical Outline: Order as part no. FX980L7

Handling precautions: This product includes input protection, however, precautions should be taken to prevent device damage from electro-static discharge. CML does not assume any responsibility for the use of any circuitry described. No IPR or circuit patent licences are implied. CML reserves the right at any time without notice to change the said circuitry and this product specification. CML has a policy of testing every product shipped using calibrated test equipment to ensure compliance with this product specification. Specific testing of all circuit parameters is not necessarily performed.



## **CONSUMER MICROCIRCUITS LIMITED**

**1 WHEATON ROAD  
WITHAM - ESSEX  
CM8 3TD - ENGLAND**

**Telephone: +44 1376 513833  
Telefax: +44 1376 518247  
e-mail: [sales@cmlmicro.co.uk](mailto:sales@cmlmicro.co.uk)  
<http://www.cmlmicro.co.uk>**