

BLM7G24S-30BG

LDMOS 2-stage power MMIC

Rev. 1 — 4 November 2013

Product data sheet

1. Product profile

1.1 General description

The BLM7G24S-30BG is a 2-stage power MMIC using NXP's state of the art Gen7 LDMOS technology. This device is perfectly suited as general purpose driver in the frequency range from 2100 MHz to 2400 MHz. Available in gull wing.

Table 1. Application performance

Typical RF performance at $T_{case} = 25\text{ }^{\circ}\text{C}$; $I_{Dq1} = 75\text{ mA}$; $I_{Dq2} = 233\text{ mA}$.

Test signal: 3GPP test model 1; 64 DPCH; clipping at 46 %; PAR = 8.4 dB at 0.01% probability on CCDF per carrier; carrier spacing = 5 MHz; unless otherwise specified in a class-AB application circuit.

Test signal	f (MHz)	V _{DS} (V)	P _{L(AV)} (W)	G _p (dB)	η _D (%)	ACPR (dBc)
2-carrier W-CDMA	2140	28	1.6	31.5	11.3	-43
2-carrier W-CDMA	2350	28	1.6	29.3	10.7	-42

1.2 Features and benefits

- Integrated temperature compensated bias
- Biasing of individual stages is externally accessible
- Integrated current sense
- Integrated ESD protection
- Excellent thermal stability
- High power gain
- On-chip matching for ease of use (input matched to 50 Ω; output partially matched)
- Designed for broadband operation (frequency 2100 MHz to 2400 MHz)
- Compliant to Directive 2002/95/EC, regarding Restriction of Hazardous Substances (RoHS)

1.3 Applications

RF power MMIC for W-CDMA base stations in the 2100 MHz to 2400 MHz frequency range.



2. Pinning information

2.1 Pinning

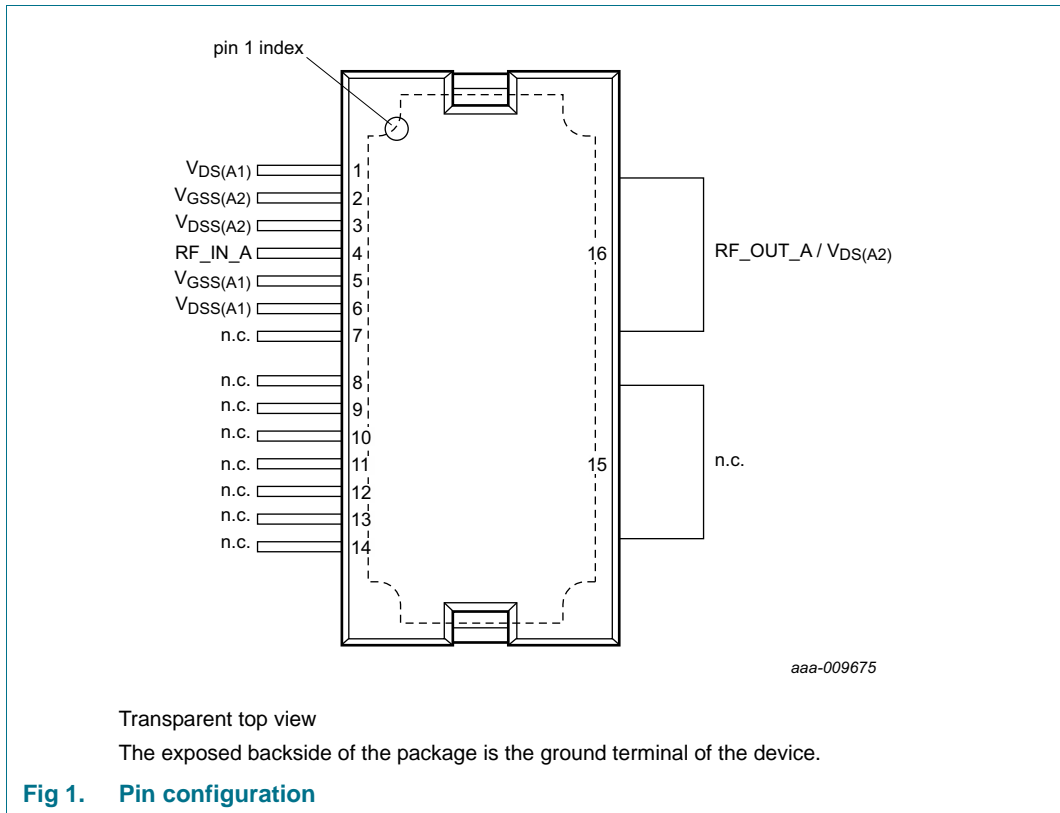

2.2 Pin description

Table 2. Pin description

Symbol	Pin	Description
$V_{DS(A1)}$	1	drain-source voltage of stage A1
$V_{GSS(A2)}$	2	gate sense FET and gate source voltage of stage A2
$V_{DSS(A2)}$	3	drain sense FET source voltage of stage A2
RF_IN_A	4	RF input path A
$V_{GSS(A1)}$	5	gate sense FET and gate source voltage of stage A1
$V_{DSS(A1)}$	6	drain sense FET source voltage of stage A1
n.c.	7	not connected
n.c.	8	not connected
n.c.	9	not connected
n.c.	10	not connected
n.c.	11	not connected
n.c.	12	not connected
n.c.	13	not connected
n.c.	14	not connected

Table 2. Pin description ...continued

Symbol	Pin	Description
n.c.	15	not connected
RF_OUT_A/V _{DS(A2)}	16	RF output path A / drain source voltage of stage A2
GND	flange	RF ground

3. Ordering information

Table 3. Ordering information

Type number	Package		Version
	Name	Description	
BLM7G24S-30BG	HSOP16	plastic, heatsink small outline package; 16 leads	SOT1212-1

4. Block diagram

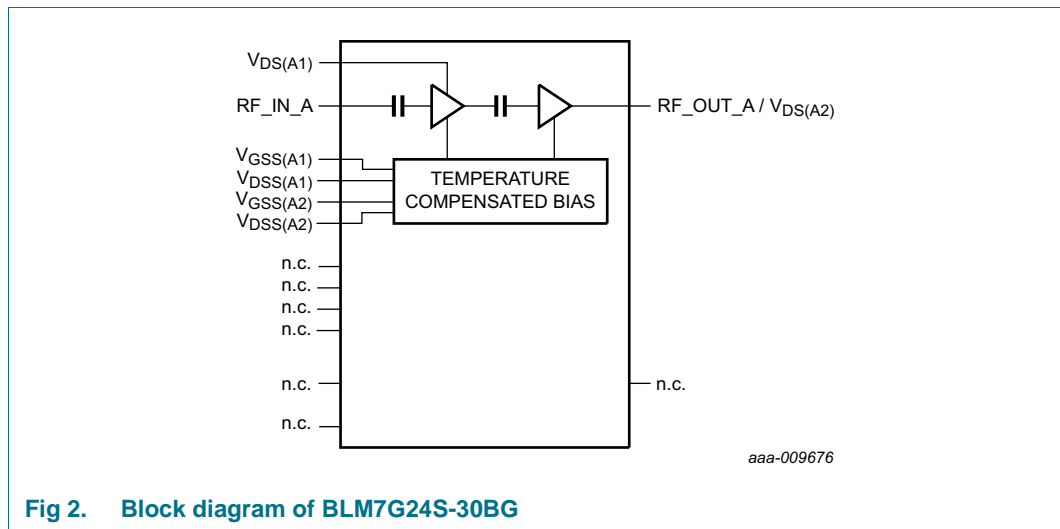

Fig 2. Block diagram of BLM7G24S-30BG

5. Limiting values

Table 4. Limiting values

In accordance with the Absolute Maximum Rating System (IEC 60134).

Symbol	Parameter	Conditions	Min	Max	Unit
V _{DS}	drain-source voltage		-	65	V
V _{GS}	gate-source voltage		-0.5	+13	V
V _{GS(sense)}	sense gate-source voltage		-0.5	+9	V
T _{stg}	storage temperature		-65	+150	°C
T _j	junction temperature		[1]	225	°C
T _{case}	case temperature		-	150	°C

[1] Continuous use at maximum temperature will affect the MTTF.

6. Thermal characteristics

Table 5. Thermal characteristics

Measured for total device.

Symbol	Parameter	Conditions	Value	Unit
$R_{th(j-c)}$	thermal resistance from junction to case	final stage; $T_{case} = 90\text{ }^{\circ}\text{C}$; $P_L = 1.6\text{ W}$	[1] 2.2	K/W
		driver stage; $T_{case} = 90\text{ }^{\circ}\text{C}$; $P_L = 1.6\text{ W}$	[1] 6.4	K/W

[1] When operated with a CW signal.

7. Characteristics

Table 6. DC characteristics

$T_{case} = 25\text{ }^{\circ}\text{C}$ unless otherwise specified.

Symbol	Parameter	Conditions	Min	Typ	Max	Unit
Final stage						
$V_{(BR)DSS}$	drain-source breakdown voltage	$V_{GS} = 0\text{ V}$; $I_D = 0.422\text{ mA}$	65	-	-	V
$V_{GS(th)}$	gate-source threshold voltage	$V_{DS} = 10\text{ V}$; $I_D = 42\text{ mA}$	1.5	1.9	2.3	V
V_{GSq}	gate-source quiescent voltage	$V_{DS} = 28\text{ V}$; $I_D = 253\text{ mA}$	1.7	2.1	2.5	V
I_{DSS}	drain leakage current	$V_{GS} = 0\text{ V}$; $V_{DS} = 28\text{ V}$	-	-	1.4	μA
I_{DSX}	drain cut-off current	$V_{GS} = V_{GS(th)} + 3.75\text{ V}$; $V_{DS} = 10\text{ V}$	-	7.8	-	A
I_{GSS}	gate leakage current	$V_{GS} = 11\text{ V}$; $V_{DS} = 0\text{ V}$	-	-	140	nA
g_{fs}	forward transconductance	$V_{DS} = 10\text{ V}$; $I_D = 1478\text{ mA}$	-	2.85	-	S
$R_{DS(on)}$	drain-source on-state resistance	$V_{GS} = V_{GS(th)} + 3.75\text{ V}$; $I_D = 1.48\text{ A}$	-	350	-	$\text{m}\Omega$
I_{Dq}	quiescent drain current	main transistor: $V_{DS} = 28\text{ V}$ sense transistor: $I_D = 7\text{ mA}$; $V_{DS} = 28\text{ V}$	208	233	257	mA
Driver stage						
$V_{(BR)DSS}$	drain-source breakdown voltage	$V_{GS} = 0\text{ V}$; $I_D = 0.116\text{ mA}$	65	-	-	V
$V_{GS(th)}$	gate-source threshold voltage	$V_{DS} = 10\text{ V}$; $I_D = 11.6\text{ mA}$	1.5	1.9	2.3	V
V_{GSq}	gate-source quiescent voltage	$V_{DS} = 28\text{ V}$; $I_D = 69.6\text{ mA}$	1.7	2.1	2.5	V
I_{DSS}	drain leakage current	$V_{GS} = 0\text{ V}$; $V_{DS} = 28\text{ V}$	-	-	1.4	μA
I_{DSX}	drain cut-off current	$V_{GS} = V_{GS(th)} + 3.75\text{ V}$; $V_{DS} = 10\text{ V}$	-	2.2	-	A
I_{GSS}	gate leakage current	$V_{GS} = 11\text{ V}$; $V_{DS} = 0\text{ V}$	-	-	140	nA
g_{fs}	forward transconductance	$V_{DS} = 10\text{ V}$; $I_D = 406\text{ mA}$	-	0.8	-	S
$R_{DS(on)}$	drain-source on-state resistance	$V_{GS} = V_{GS(th)} + 3.75\text{ V}$; $I_D = 0.4\text{ A}$	-	2350	-	$\text{m}\Omega$
I_{Dq}	quiescent drain current	main transistor: $V_{DS} = 28\text{ V}$ sense transistor: $I_D = 7\text{ mA}$; $V_{DS} = 28\text{ V}$	67	75	83	mA

Table 7. RF Characteristics

Typical RF performance at $T_{case} = 25\text{ °C}$; $V_{DS} = 28\text{ V}$; $I_{Dq1} = 75\text{ mA}$; $I_{Dq2} = 233\text{ mA}$. Test signal: 2-carrier W-CDMA; 3GPP test model 1; 64 DPCH; clipping at 46 %; PAR = 8.4 dB at 0.01% probability on CCDF per carrier; carrier spacing = 5 MHz; $f_1 = 2112.5\text{ MHz}$; $f_2 = 2117.5\text{ MHz}$; $f_3 = 2162.5\text{ MHz}$; $f_4 = 2167.5\text{ MHz}$; unless otherwise specified measured in a class-AB production circuit.

Symbol	Parameter	Conditions	Min	Typ	Max	Unit
G_p	power gain	$P_{L(AV)} = 1.6\text{ W}$	29.5	31.5	33.5	dB
η_D	drain efficiency	$P_{L(AV)} = 1.6\text{ W}$	10	11.3	-	%
RL_{in}	input return loss	$P_{L(AV)} = 1.6\text{ W}$	-	-17	-10	dB
ACPR	adjacent channel power ratio	$P_{L(AV)} = 1.6\text{ W}$	-	-43	-40	dBc

8. Application information

8.1 Circuit information for application circuit (2.1 GHz to 2.2 GHz)

Table 8. List of components

For test circuit see [Figure 3](#).

Component	Description	Value	Remarks
C1, C4, C100, C200	capacitor	10 μF	
C2, C5, C6,	capacitor	1 μF	
C3, C7, C10	capacitor	8.2 pF	[1]
C8	capacitor	1.6 pF	[1]
C9	capacitor	0.4 pF	[1]
C11	electrolytic capacitor	470 μF	
C101, C201	capacitor	100 nF	
C102, C103, C105, C202, C203, C205	capacitor	12 pF	[2]
C104, C204	capacitor	4.7 μF	
C21, C22, C23, C24, C25, C26, C27, C28, C29, C30, C31, C300, C301, C302, C303, C304, C305, C400, C401, C402, C403, C404, C405	capacitor	-	not mounted
D100, D200	IC: LM4051	-	
D300, D400	IC	-	not mounted
P100	potentiometer	-	do not populate
P400	potentiometer	-	not mounted
Q100, Q200	IC	-	LM7341
Q300, Q400	IC	-	not mounted
R1	ferrite bead	-	
R100, R200	resistor	4.7 Ω	
R101, R108, R110, R208	resistor	0 Ω	
R102	resistor	360 Ω	1% tolerance
R103	resistor	330 Ω	1% tolerance
R104, R203	resistor	68 k Ω	
R105	resistor	10 k Ω	

Table 8. List of components ...continued
For test circuit see [Figure 3](#).

Component	Description	Value	Remarks
R106, R205	resistor	820 Ω	
R107, R206	resistor	47 Ω	
R109, R209	resistor	300 k Ω	
R201	resistor	180 Ω	1% tolerance
R202	resistor	3.6 k Ω	1% tolerance
R204	resistor	9.1 k Ω	
R207	resistor	1 k Ω	
R21, R300, R301, R302, R303, R304, R305, R306, R307, R308, R309, R400, R401, R402, R403, R404, R405, R406, R407, R408, R409	resistor	-	not mounted

[1] American Technical Ceramics type 100B or capacitor of same quality.

[2] American Technical Ceramics type 100A or capacitor of same quality.

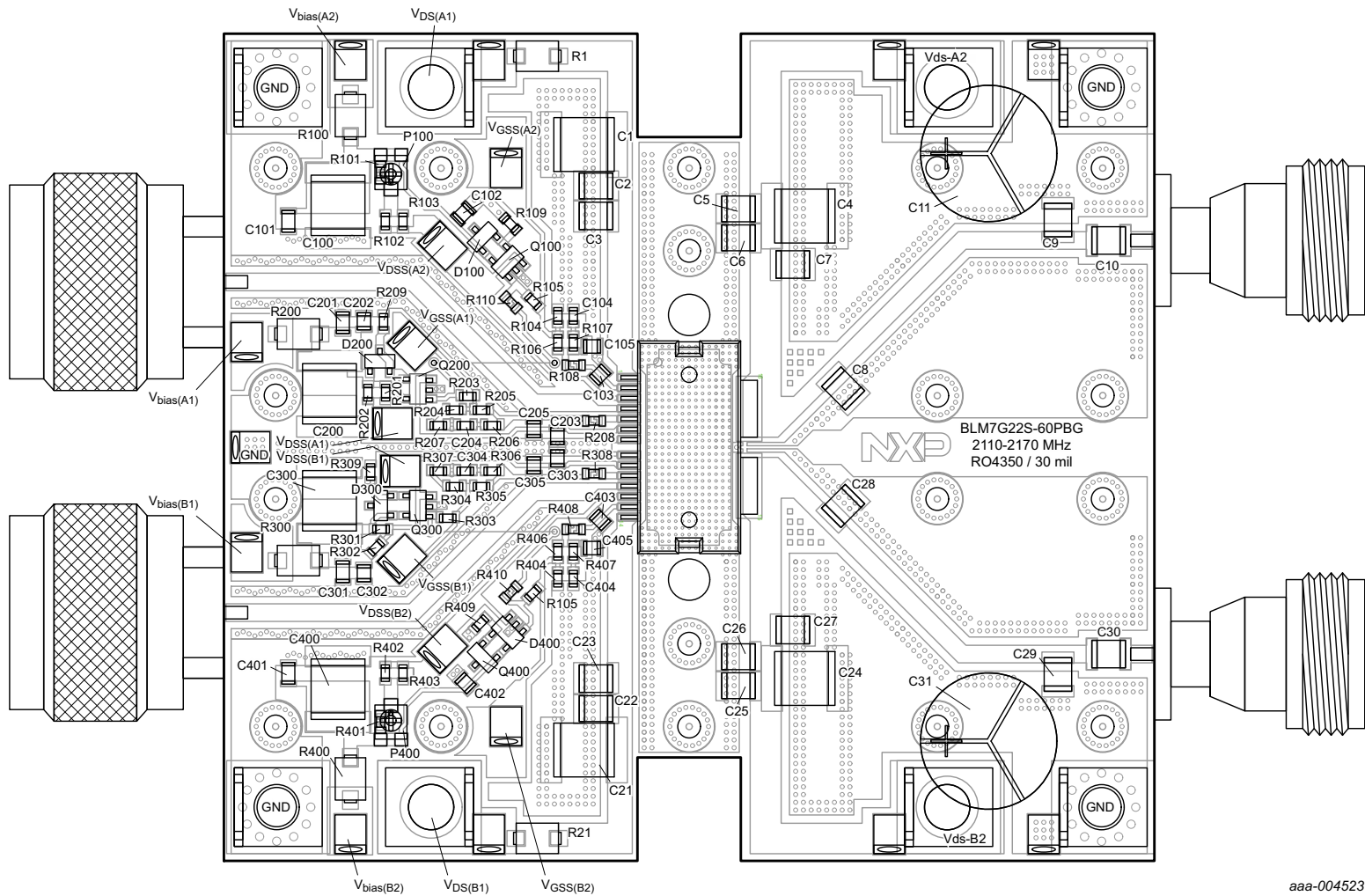

aaa-004523

Printed-Circuit Board (PCB): Rogers 4350; thickness = 0.762 mm.
 See [Table 8](#) for a list of components.

Fig 3. Component layout for class-AB application circuit with auto-bias (a half section of the BLM7G22S-60PBG [section A] is used for characterization)

8.2 Performance curves (2.1 GHz to 2.2 GHz)

Performance curves are measured in a class-AB dedicated application circuit with auto-bias from 2.1 GHz to 2.2 GHz, see [Table 8](#) and [Figure 3](#).

8.2.1 W-CDMA

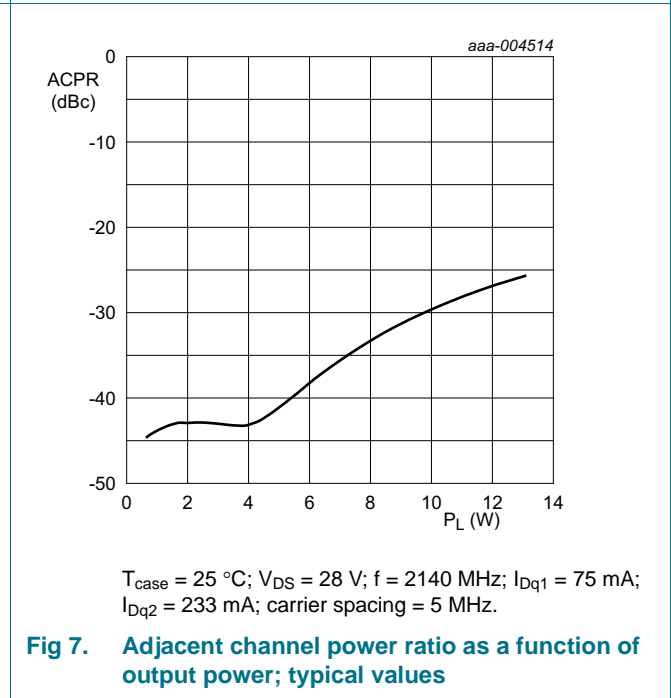
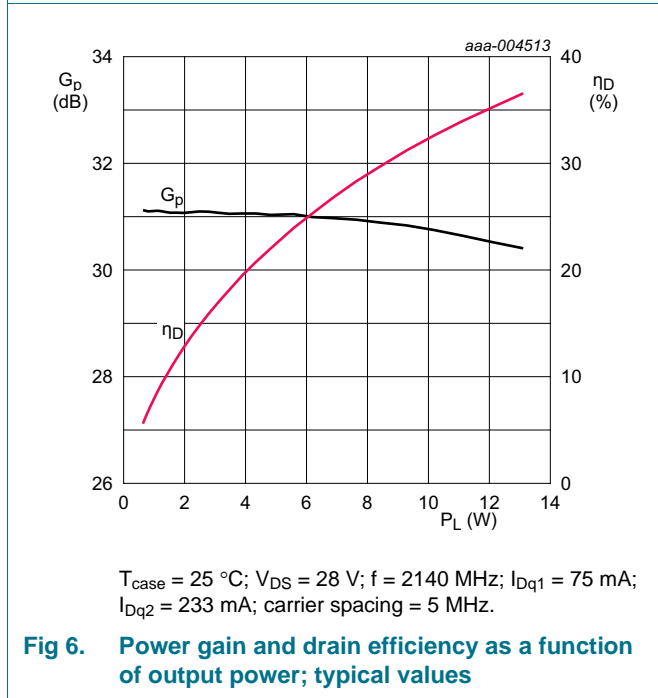
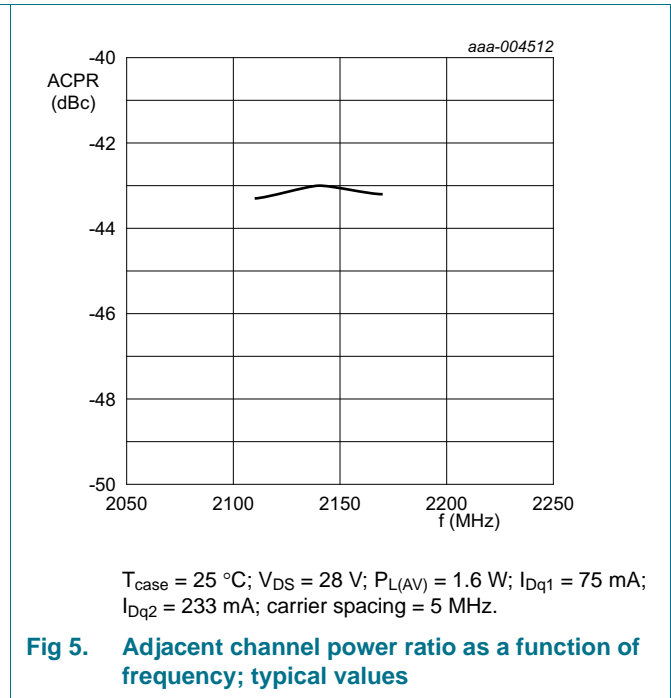
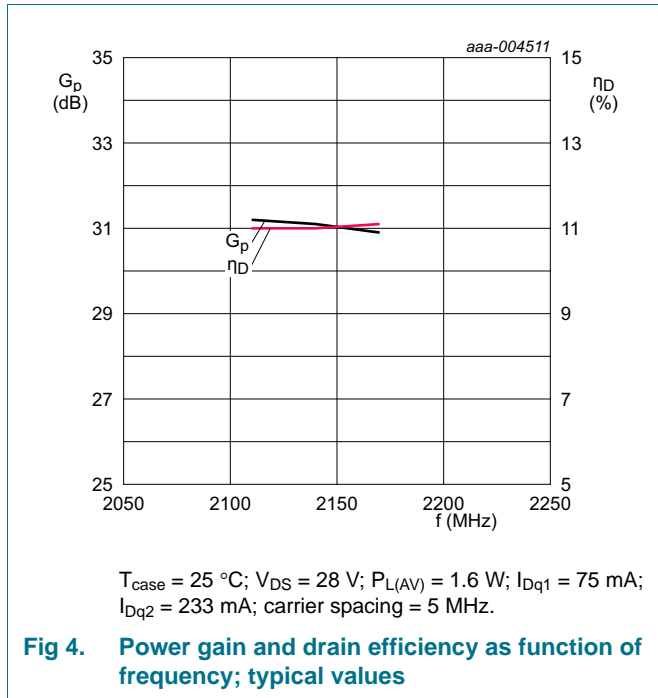

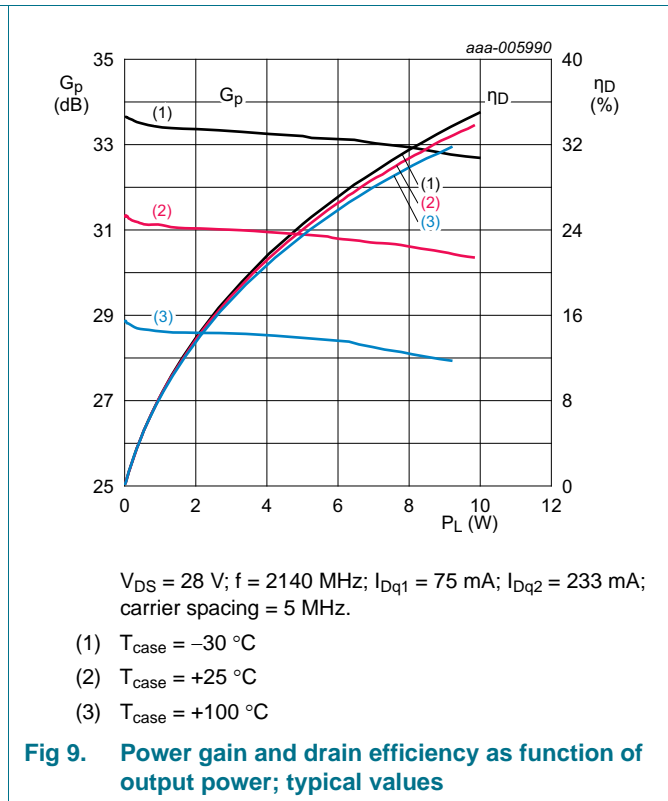
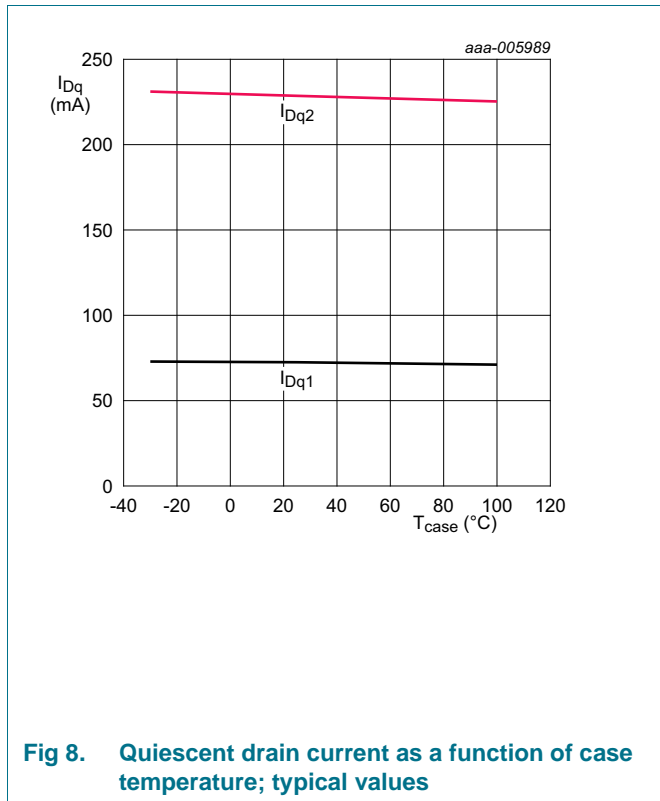

8.2.2 1-Tone pulsed CW

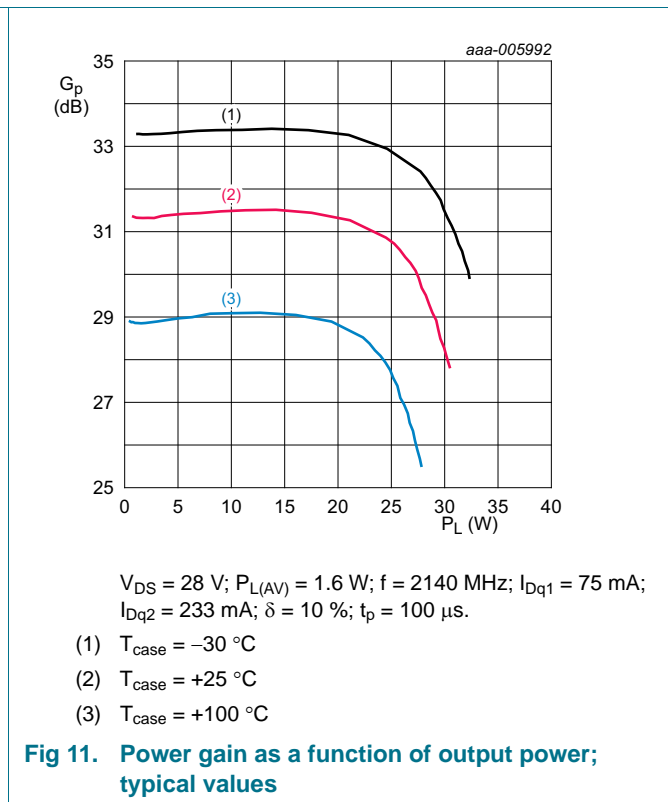
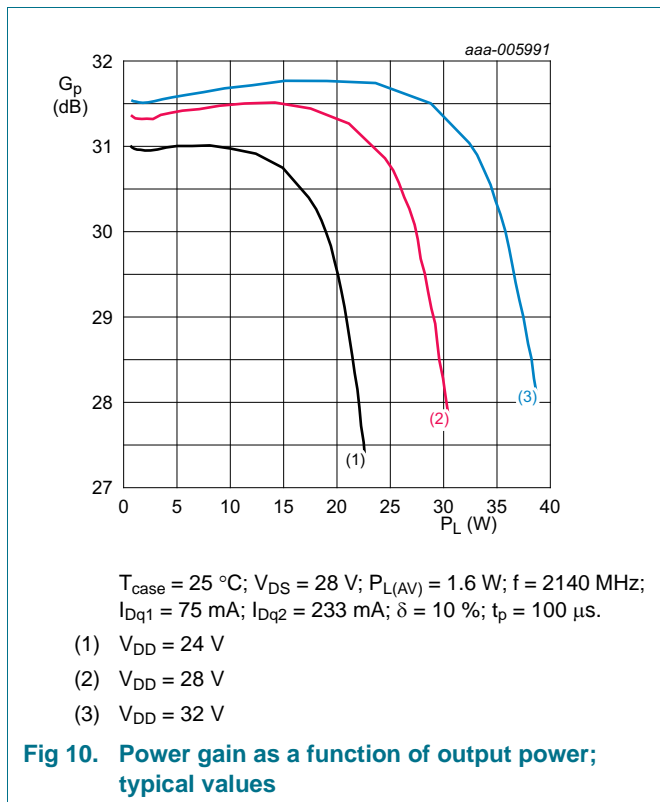

8.2.3 2-Tone CW

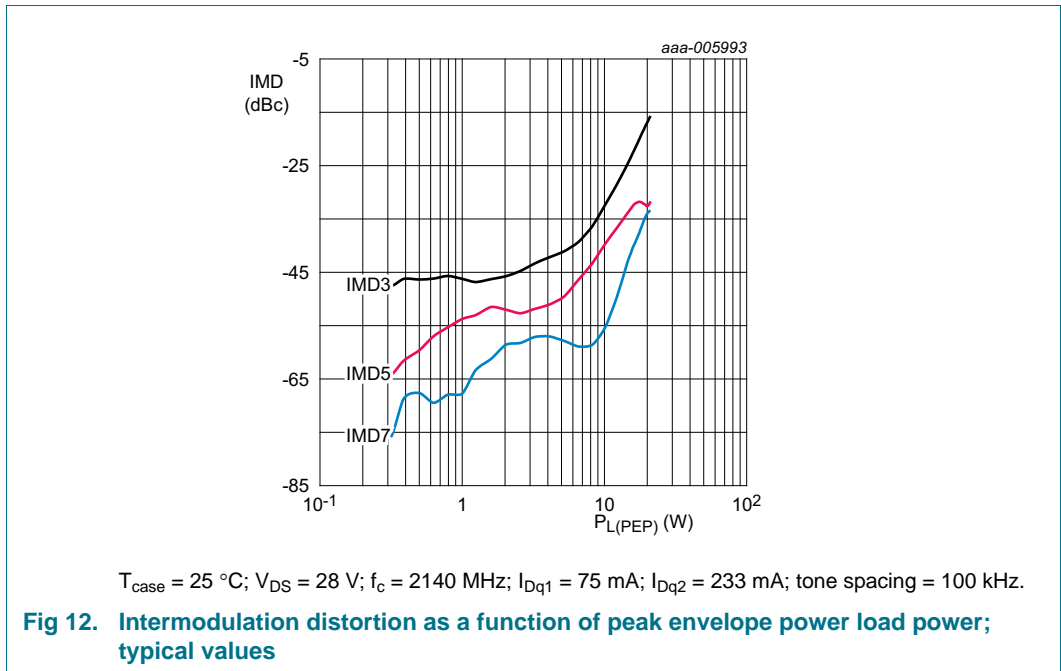

8.3 Performance curves (2.3 GHz to 2.4 GHz)

Performance curves are measured in a class-AB dedicated application circuit with auto-bias from 2.3 GHz to 2.4 GHz.

8.3.1 2-Carrier W-CDMA

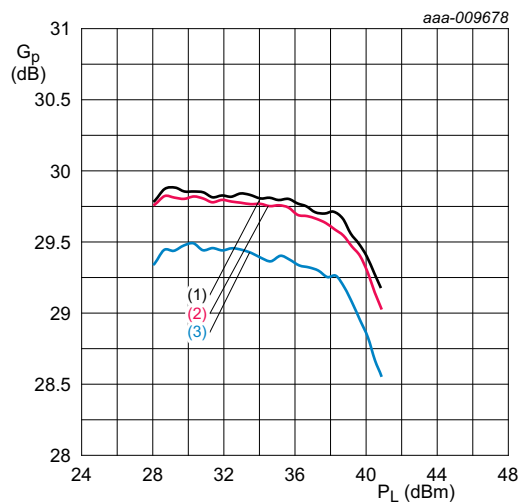

$V_{DS} = 28\text{ V}$; $I_{Dq1} = 220\text{ mA}$; $I_{Dq2} = 75\text{ mA}$; carrier spacing = 5MHz.

- (1) $f = 2300\text{ MHz}$
- (2) $f = 2350\text{ MHz}$
- (3) $f = 2400\text{ MHz}$

Fig 13. Power gain as a function of output power; typical values

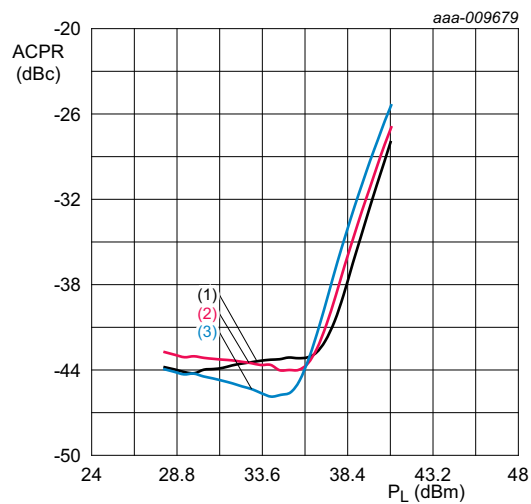

$V_{DS} = 28\text{ V}$; $I_{Dq1} = 220\text{ mA}$; $I_{Dq2} = 75\text{ mA}$; carrier spacing = 5MHz.

- (1) $f = 2300\text{ MHz}$
- (2) $f = 2350\text{ MHz}$
- (3) $f = 2400\text{ MHz}$

Fig 14. Adjacent channel power ratio as a function of output power; typical values

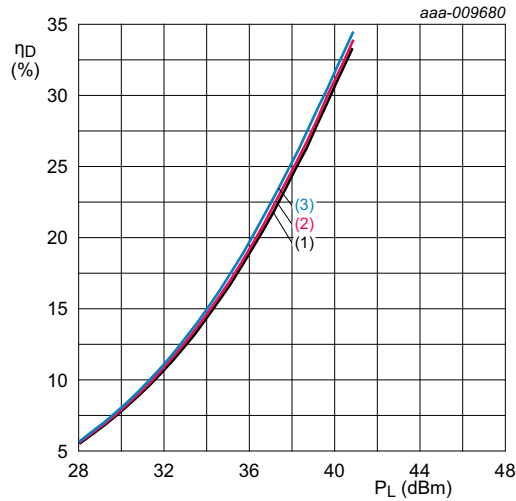

$V_{DS} = 28\text{ V}$; $I_{DQ1} = 220\text{ mA}$; $I_{DQ2} = 75\text{ mA}$; carrier spacing = 5MHz.
 (1) $f = 2300\text{ MHz}$
 (2) $f = 2350\text{ MHz}$
 (3) $f = 2400\text{ MHz}$

Fig 15. Drain efficiency as a function of output power; typical values

8.3.2 Pulsed CW

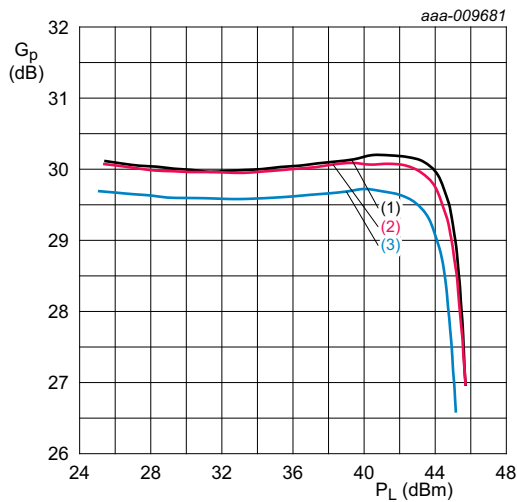

$V_{DS} = 28\text{ V}$; $I_{DQ1} = 220\text{ mA}$; $I_{DQ2} = 75\text{ mA}$; $\delta = 10\%$;
 $t_p = 100\ \mu\text{s}$.
 (1) $f = 2300\text{ MHz}$
 (2) $f = 2350\text{ MHz}$
 (3) $f = 2400\text{ MHz}$

Fig 16. Power gain as a function of output power; typical values

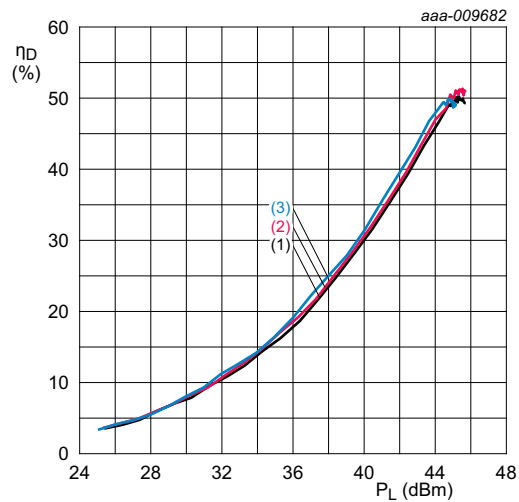

$V_{DS} = 28\text{ V}$; $I_{DQ1} = 220\text{ mA}$; $I_{DQ2} = 75\text{ mA}$; $\delta = 10\%$;
 $t_p = 100\ \mu\text{s}$.
 (1) $f = 2300\text{ MHz}$
 (2) $f = 2350\text{ MHz}$
 (3) $f = 2400\text{ MHz}$

Fig 17. Efficiency as a function of output power; typical values

8.4 Application without auto-bias

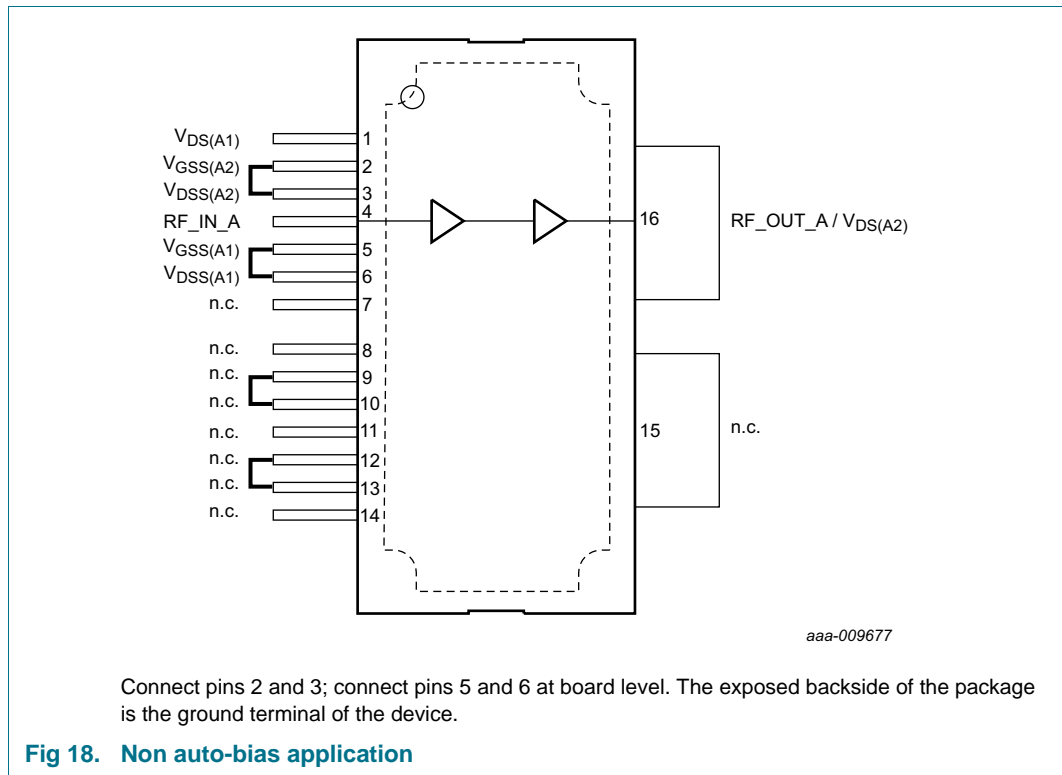

9. Test information

9.1 Ruggedness

The BLM7G24S-30BG is capable of withstanding a load mismatch corresponding to VSWR = 10 : 1 through all phases under the following conditions: $V_{DS} = 28\text{ V}$; $I_{Dq1} = 75\text{ mA}$; $I_{Dq2} = 233\text{ mA}$; $P_L = 27\text{ W}$ (W-CDMA); $f = 2140\text{ MHz}$.

9.2 Impedance information

Table 9. Typical impedance

Measured load-pull data. Typical values per section unless otherwise specified.

f (MHz)	Z _S [1] (Ω)	Z _L [1] (Ω)
2080	55.62 + j18.89	15.89 – j2.28
2110	55.61 + j19.04	14.74 – j2.59
2140	55.60 + j19.12	13.56 – j2.75
2170	55.57 + j19.25	12.38 – j2.75
2200	55.53 + j19.39	11.20 – j2.61
2230	55.48 + j19.55	10.05 – j2.34
2300	34.51 + j41.45	7.06 – j6.36

Table 9. Typical impedance ...continued

Measured load-pull data. Typical values per section unless otherwise specified.

f (MHz)	Z _S [1] (Ω)	Z _L [1] (Ω)
2350	29.26 + j36.91	6.35 – j6.24
2400	22.86 + j32.52	5.65 – j6.15

[1] Z_S and Z_L defined in [Figure 19](#).

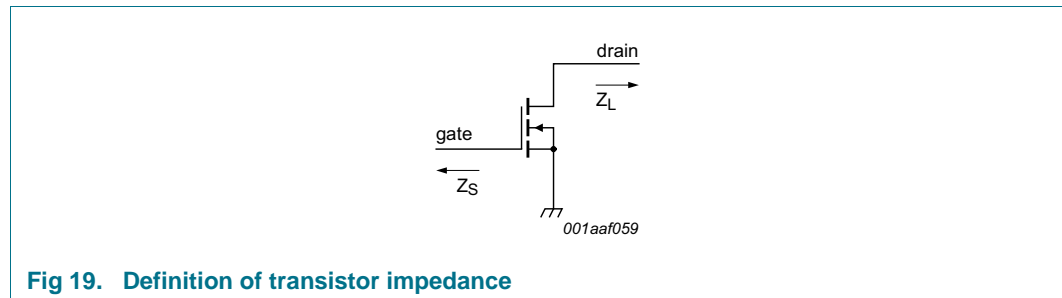

Fig 19. Definition of transistor impedance

9.3 Performance curves

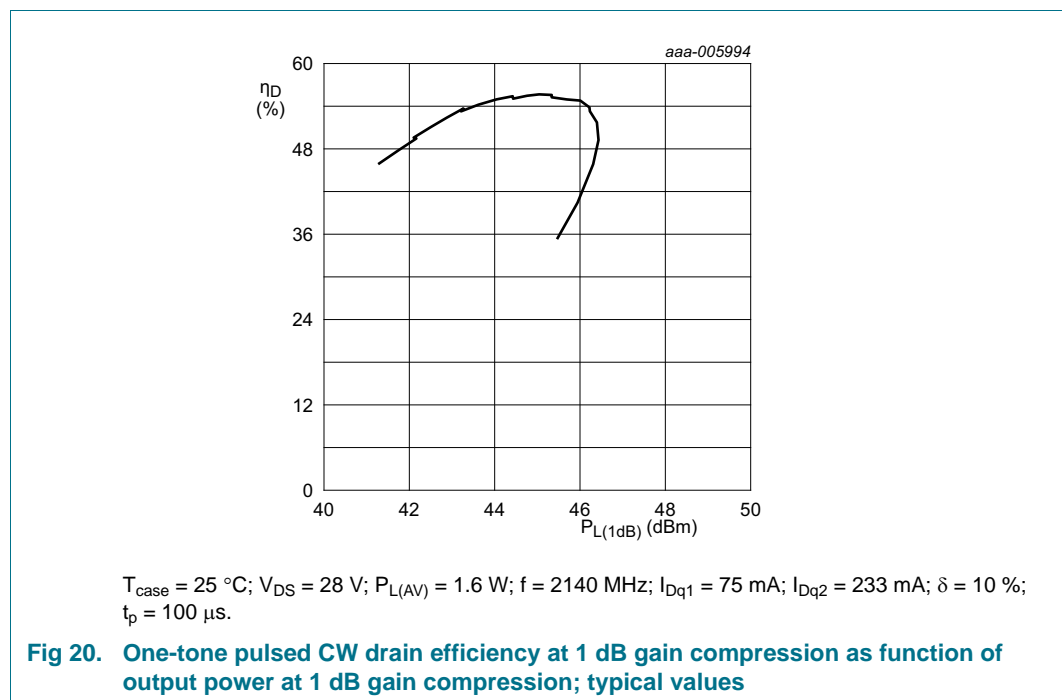

Fig 20. One-tone pulsed CW drain efficiency at 1 dB gain compression as function of output power at 1 dB gain compression; typical values

10. Package outline

HSOP16: plastic, heatsink small outline package; 16 leads

SOT1212-1

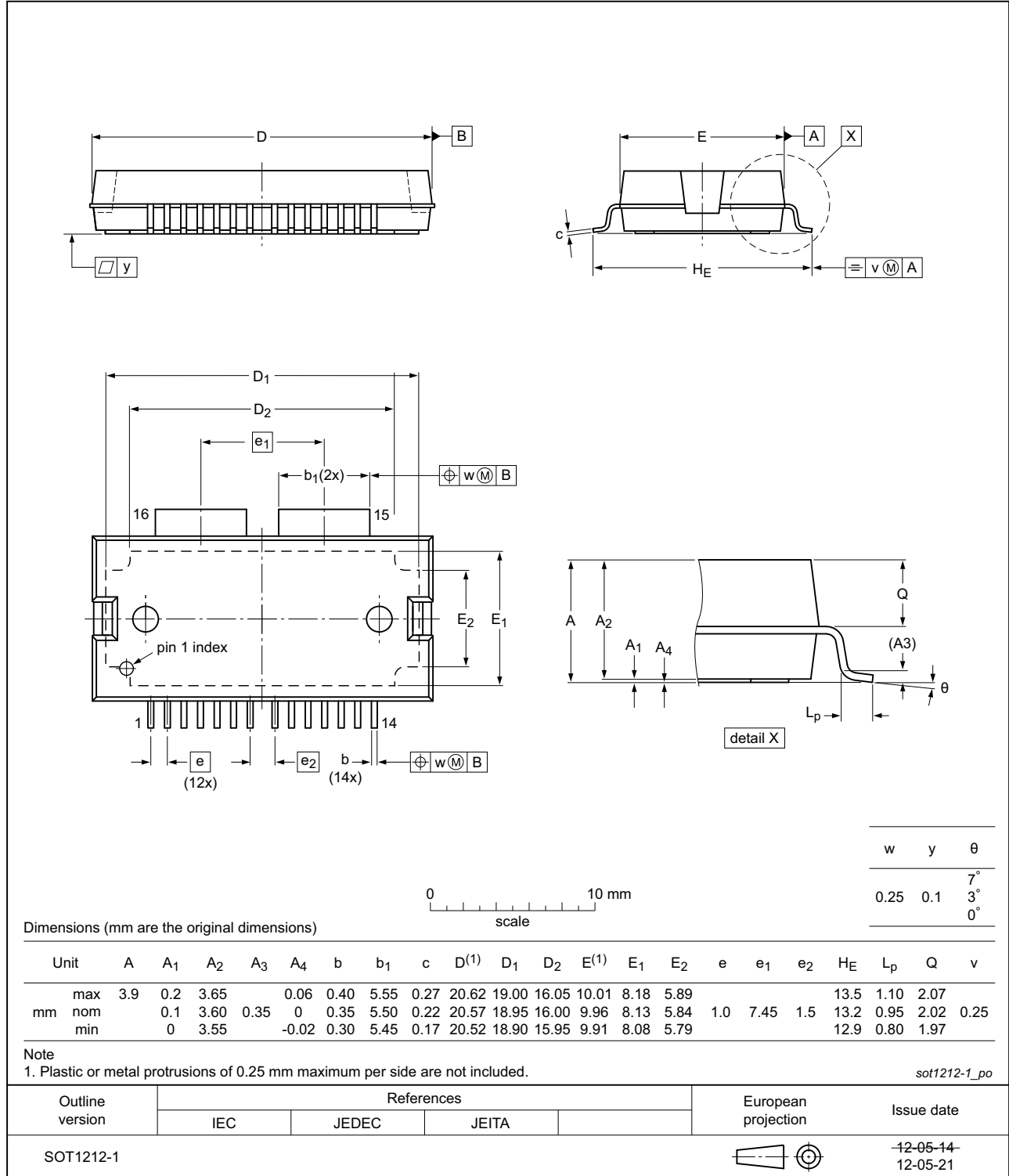

Fig 21. Package outline SOT1212-1 (HSOP16)

11. Handling information

CAUTION



This device is sensitive to ElectroStatic Discharge (ESD). Observe precautions for handling electrostatic sensitive devices.

Such precautions are described in the *ANSI/ESD S20.20*, *IEC/ST 61340-5*, *JESD625-A* or equivalent standards.

12. Abbreviations

Table 10. Abbreviations

Acronym	Description
3GPP	3rd Generation Partnership Project
CCDF	Complementary Cumulative Distribution Function
CW	Continuous Waveform
DPCH	Dedicated Physical CHannel
ESD	ElectroStatic Discharge
FET	Field-Effect Transistor
Gen7	Seventh-Generation
LDMOS	Laterally Diffused Metal Oxide Semiconductor
MMIC	Monolithic Microwave Integrated Circuit
MTTF	Mean Time To Failure
PAR	Peak-to-Average Ratio
VSWR	Voltage Standing Wave Ratio
W-CDMA	Wideband Code Division Multiple Access

13. Revision history

Table 11. Revision history

Document ID	Release date	Data sheet status	Change notice	Supersedes
BLM7G24S-30BG v.1	20131104	Product data sheet	-	-

14. Legal information

14.1 Data sheet status

Document status ^{[1][2]}	Product status ^[3]	Definition
Objective [short] data sheet	Development	This document contains data from the objective specification for product development.
Preliminary [short] data sheet	Qualification	This document contains data from the preliminary specification.
Product [short] data sheet	Production	This document contains the product specification.

[1] Please consult the most recently issued document before initiating or completing a design.

[2] The term 'short data sheet' is explained in section "Definitions".

[3] The product status of device(s) described in this document may have changed since this document was published and may differ in case of multiple devices. The latest product status information is available on the Internet at URL <http://www.nxp.com>.

14.2 Definitions

Draft — The document is a draft version only. The content is still under internal review and subject to formal approval, which may result in modifications or additions. NXP Semiconductors does not give any representations or warranties as to the accuracy or completeness of information included herein and shall have no liability for the consequences of use of such information.

Short data sheet — A short data sheet is an extract from a full data sheet with the same product type number(s) and title. A short data sheet is intended for quick reference only and should not be relied upon to contain detailed and full information. For detailed and full information see the relevant full data sheet, which is available on request via the local NXP Semiconductors sales office. In case of any inconsistency or conflict with the short data sheet, the full data sheet shall prevail.

Product specification — The information and data provided in a Product data sheet shall define the specification of the product as agreed between NXP Semiconductors and its customer, unless NXP Semiconductors and customer have explicitly agreed otherwise in writing. In no event however, shall an agreement be valid in which the NXP Semiconductors product is deemed to offer functions and qualities beyond those described in the Product data sheet.

14.3 Disclaimers

Limited warranty and liability — Information in this document is believed to be accurate and reliable. However, NXP Semiconductors does not give any representations or warranties, expressed or implied, as to the accuracy or completeness of such information and shall have no liability for the consequences of use of such information. NXP Semiconductors takes no responsibility for the content in this document if provided by an information source outside of NXP Semiconductors.

In no event shall NXP Semiconductors be liable for any indirect, incidental, punitive, special or consequential damages (including - without limitation - lost profits, lost savings, business interruption, costs related to the removal or replacement of any products or rework charges) whether or not such damages are based on tort (including negligence), warranty, breach of contract or any other legal theory.

Notwithstanding any damages that customer might incur for any reason whatsoever, NXP Semiconductors' aggregate and cumulative liability towards customer for the products described herein shall be limited in accordance with the *Terms and conditions of commercial sale* of NXP Semiconductors.

Right to make changes — NXP Semiconductors reserves the right to make changes to information published in this document, including without limitation specifications and product descriptions, at any time and without notice. This document supersedes and replaces all information supplied prior to the publication hereof.

Suitability for use — NXP Semiconductors products are not designed, authorized or warranted to be suitable for use in life support, life-critical or safety-critical systems or equipment, nor in applications where failure or malfunction of an NXP Semiconductors product can reasonably be expected to result in personal injury, death or severe property or environmental damage. NXP Semiconductors and its suppliers accept no liability for inclusion and/or use of NXP Semiconductors products in such equipment or applications and therefore such inclusion and/or use is at the customer's own risk.

Applications — Applications that are described herein for any of these products are for illustrative purposes only. NXP Semiconductors makes no representation or warranty that such applications will be suitable for the specified use without further testing or modification.

Customers are responsible for the design and operation of their applications and products using NXP Semiconductors products, and NXP Semiconductors accepts no liability for any assistance with applications or customer product design. It is customer's sole responsibility to determine whether the NXP Semiconductors product is suitable and fit for the customer's applications and products planned, as well as for the planned application and use of customer's third party customer(s). Customers should provide appropriate design and operating safeguards to minimize the risks associated with their applications and products.

NXP Semiconductors does not accept any liability related to any default, damage, costs or problem which is based on any weakness or default in the customer's applications or products, or the application or use by customer's third party customer(s). Customer is responsible for doing all necessary testing for the customer's applications and products using NXP Semiconductors products in order to avoid a default of the applications and the products or of the application or use by customer's third party customer(s). NXP does not accept any liability in this respect.

Limiting values — Stress above one or more limiting values (as defined in the Absolute Maximum Ratings System of IEC 60134) will cause permanent damage to the device. Limiting values are stress ratings only and (proper) operation of the device at these or any other conditions above those given in the Recommended operating conditions section (if present) or the Characteristics sections of this document is not warranted. Constant or repeated exposure to limiting values will permanently and irreversibly affect the quality and reliability of the device.

Terms and conditions of commercial sale — NXP Semiconductors products are sold subject to the general terms and conditions of commercial sale, as published at <http://www.nxp.com/profile/terms>, unless otherwise agreed in a valid written individual agreement. In case an individual agreement is concluded only the terms and conditions of the respective agreement shall apply. NXP Semiconductors hereby expressly objects to applying the customer's general terms and conditions with regard to the purchase of NXP Semiconductors products by customer.

No offer to sell or license — Nothing in this document may be interpreted or construed as an offer to sell products that is open for acceptance or the grant, conveyance or implication of any license under any copyrights, patents or other industrial or intellectual property rights.

Export control — This document as well as the item(s) described herein may be subject to export control regulations. Export might require a prior authorization from competent authorities.

Non-automotive qualified products — Unless this data sheet expressly states that this specific NXP Semiconductors product is automotive qualified, the product is not suitable for automotive use. It is neither qualified nor tested in accordance with automotive testing or application requirements. NXP Semiconductors accepts no liability for inclusion and/or use of non-automotive qualified products in automotive equipment or applications.

In the event that customer uses the product for design-in and use in automotive applications to automotive specifications and standards, customer (a) shall use the product without NXP Semiconductors' warranty of the product for such automotive applications, use and specifications, and (b) whenever customer uses the product for automotive applications beyond

NXP Semiconductors' specifications such use shall be solely at customer's own risk, and (c) customer fully indemnifies NXP Semiconductors for any liability, damages or failed product claims resulting from customer design and use of the product for automotive applications beyond NXP Semiconductors' standard warranty and NXP Semiconductors' product specifications.

Translations — A non-English (translated) version of a document is for reference only. The English version shall prevail in case of any discrepancy between the translated and English versions.

14.4 Trademarks

Notice: All referenced brands, product names, service names and trademarks are the property of their respective owners.

15. Contact information

For more information, please visit: <http://www.nxp.com>

For sales office addresses, please send an email to: salesaddresses@nxp.com

16. Contents

1	Product profile	1
1.1	General description	1
1.2	Features and benefits	1
1.3	Applications	1
2	Pinning information	2
2.1	Pinning	2
2.2	Pin description	2
3	Ordering information	3
4	Block diagram	3
5	Limiting values	3
6	Thermal characteristics	4
7	Characteristics	4
8	Application information	5
8.1	Circuit information for application circuit (2.1 GHz to 2.2 GHz)	5
8.2	Performance curves (2.1 GHz to 2.2 GHz) . . .	8
8.2.1	W-CDMA	8
8.2.2	1-Tone pulsed CW	9
8.2.3	2-Tone CW	10
8.3	Performance curves (2.3 GHz to 2.4 GHz) . . .	11
8.3.1	2-Carrier W-CDMA	11
8.3.2	Pulsed CW	12
8.4	Application without auto-bias	13
9	Test information	13
9.1	Ruggedness	13
9.2	Impedance information	13
9.3	Performance curves	14
10	Package outline	15
11	Handling information	16
12	Abbreviations	16
13	Revision history	16
14	Legal information	17
14.1	Data sheet status	17
14.2	Definitions	17
14.3	Disclaimers	17
14.4	Trademarks	18
15	Contact information	18
16	Contents	19

Please be aware that important notices concerning this document and the product(s) described herein, have been included in section 'Legal information'.

© NXP B.V. 2013.

All rights reserved.

For more information, please visit: <http://www.nxp.com>

For sales office addresses, please send an email to: salesaddresses@nxp.com

Date of release: 4 November 2013

Document identifier: BLM7G24S-30BG