



UK3568

Power MOSFET

SILICON N-CHANNEL MOS TYPE

DESCRIPTION

The **UK3568** uses advanced trench technology to provide excellent $R_{DS(ON)}$, low gate charge and operation with low gate voltages. This device is suitable for use as a load switch or in PWM applications.

FEATURES

- * $R_{DS(ON)} < 0.4\Omega$ @ $V_{GS}=10V, I_D=6A$
- * Low Capacitance
- * Low Gate Charge
- * Fast Switching Capability
- * Avalanche Energy Specified

SYMBOL

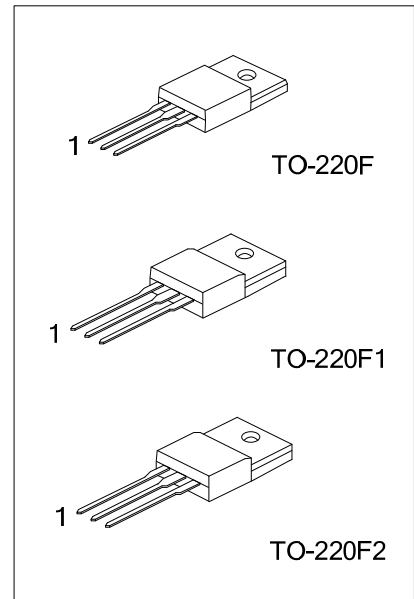
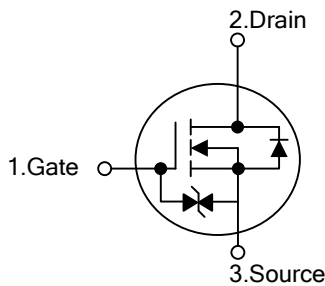

ORDERING INFORMATION

Ordering Number		Package	Pin Assignment			Packing
Lead Free	Halogen Free		1	2	3	
UK3568L-TF1-T	UK3568G-TF1-T	TO-220F1	G	D	S	Tube
UK3568L-TF2-T	UK3568G-TF2-T	TO-220F2	G	D	S	Tube
UK3568L-TF3-T	UK3568G-TF3-T	TO-220F	G	D	S	Tube

Note: Pin Assignment: G: Gate D: Drain S: Source

<p>UK3568L-TF3-T</p> <p>(1) Packing Type</p> <p>(2) Package Type</p> <p>(3) Green Package</p>	<p>(1) T: Tube</p> <p>(2) TF3: TO-220F, TF1: TO-220F1, TF2: TO-220F2</p> <p>(3) L: Lead Free, G: Halogen Free and Lead Free</p>
---	---

MARKING

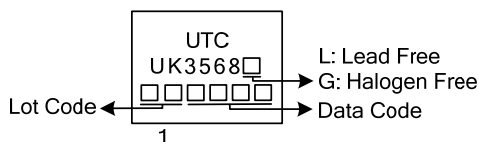

■ ABSOLUTE MAXIMUM RATINGS ($T_A = 25^\circ\text{C}$, unless otherwise specified)

PARAMETER		SYMBOL	RATINGS	UNIT
Drain-Source Voltage		V_{DSS}	500	V
Drain-Gate Voltage ($R_G=20k\Omega$)		V_{DGR}	500	V
Gate-Source Voltage		V_{GSS}	± 30	V
Continuous Drain Current (Note 2)	DC	I_D	12	A
	Pulse($t=1\text{ms}$)		48	
Avalanche Current		I_{AR}	12	A
Avalanche Energy	Single Pulsed (Note 3)	E_{AS}	364	mJ
	Repetitive (Note 4)	E_{AR}	4	
Power Dissipation ($T_C=25^\circ\text{C}$)	TO-220F/TO-220F1	P_D	40	W
	TO-220F2		42	
Junction Temperature		T_J	+150	$^\circ\text{C}$
Storage Temperature		T_{STG}	-55 ~ +150	$^\circ\text{C}$

Note: 1. Absolute maximum ratings are those values beyond which the device could be permanently damaged.

Absolute maximum ratings are stress ratings only and functional device operation is not implied.

2. Ensure that the temperature will not exceed 150°C .

3. $V_{DD}=90\text{V}$, $T_{CH}=25^\circ\text{C}$ (initial), $L=4.3\text{mH}$, $I_{AR}=12\text{A}$, $R_G=25\Omega$

4. Repetitive rating: pulse width limited by maximum channel temperature

■ THERMAL DATA

PARAMETER		SYMBOL	RATINGS	UNIT
Junction to Ambient		θ_{JA}	62.5	$^\circ\text{C/W}$
Junction to Case	TO-220F/TO-220F1	θ_{JC}	3.125	$^\circ\text{C/W}$
	TO-220F2		2.98	

■ ELECTRICAL CHARACTERISTICS ($T_A=25^\circ\text{C}$, unless otherwise specified)

PARAMETER	SYMBOL	TEST CONDITIONS	MIN	TYP	MAX	UNIT
OFF CHARACTERISTICS						
Drain-Source Breakdown Voltage	BV_{DSS}	$V_{GS}=0V, I_D=250\mu A$	500			V
Drain-Source Leakage Current	I_{DSS}	$V_{DS}=500V, V_{GS}=0V$			100	μA
Gate-Source Leakage Current	I_{GSS}	$V_{DS}=0V, V_{GS}=\pm 25V$			± 10	μA
ON CHARACTERISTICS						
Gate-Source Breakdown Voltage	BV_{GSS}	$I_G=\pm 10\mu A, V_{DS}=0V$	± 30			V
Gate Threshold Voltage	$V_{GS(TH)}$	$V_{DS}=10V, I_D=250\mu A$	2.0		4.0	V
On State Drain Current	$I_{D(ON)}$					A
Static Drain-Source On-Resistance	$R_{DS(ON)}$	$V_{GS}=10V, I_D=6A$		0.4	0.52	Ω
DYNAMIC PARAMETERS						
Input Capacitance	C_{ISS}	$V_{DS}=25V, V_{GS}=0V, f=1\text{MHz}$		1500		pF
Output Capacitance	C_{OSS}			180		pF
Reverse Transfer Capacitance	C_{RSS}			15		pF
SWITCHING PARAMETERS						
Turn-ON Delay Time	$t_{D(ON)}$	$V_{GS}=10V, V_{DD}\approx 30V, R_L=25\Omega, I_D=0.5A$		70		ns
Turn-ON Rise Time	t_R			155		ns
Turn-OFF Delay Time	$t_{D(OFF)}$			490		ns
Turn-OFF Fall-Time	t_F			230		ns
Total Gate Charge	Q_G	$V_{DD}=50V, V_{GS}=10V, I_D=1.3A, I_G=100\mu A$		60		nC
Gate Source Charge	Q_{GS}			10		nC
Gate Drain Charge	Q_{GD}			19		nC
SOURCE- DRAIN DIODE RATINGS AND CHARACTERISTICS						
Diode Forward Voltage	V_{SD}	$I_{DR}=12A, V_{GS}=0V$			1.7	V
Continuous Drain Reverse Current	I_D				12	A
Pulse Drain Reverse Current	I_{DR}				48	A
Reverse Recovery Time	t_{rr}	$I_{DR}=12A, V_{GS}=0V, dI/dt=100A/\mu s$		1200		ns
Reverse Recovery Charge	Q_{RR}			16		μC

TYPICAL CHARACTERISTICS

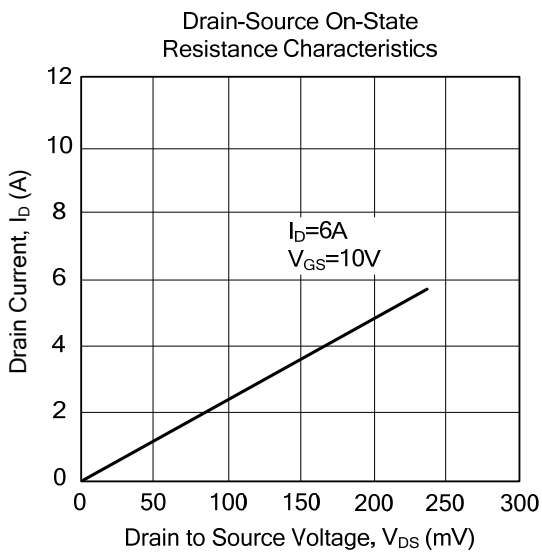
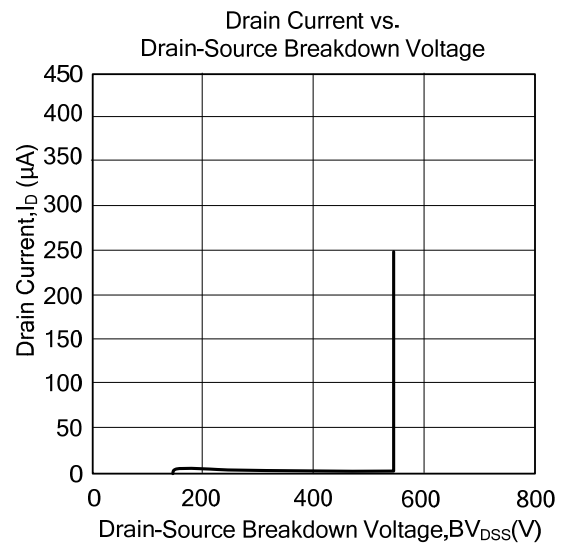
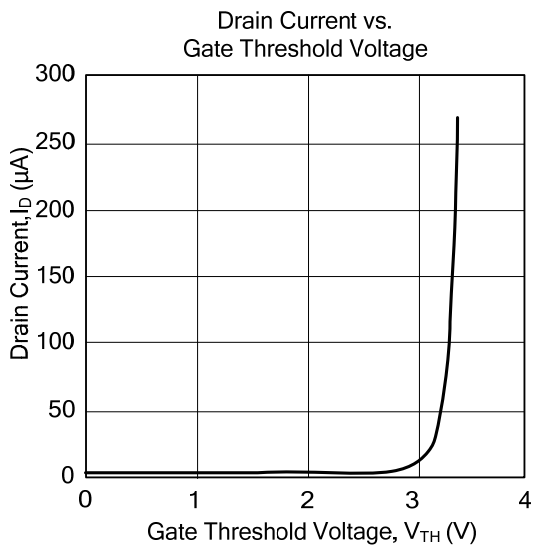
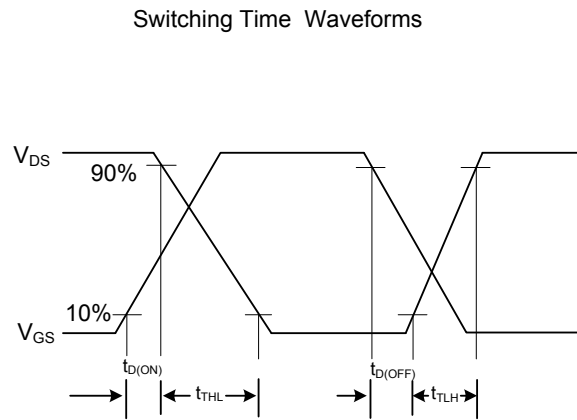
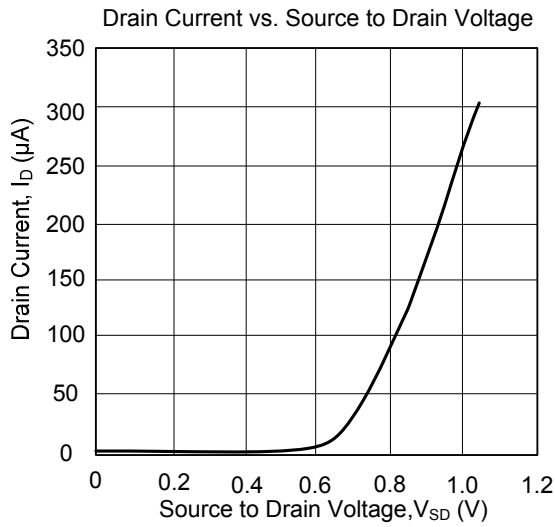

UTC assumes no responsibility for equipment failures that result from using products at values that exceed, even momentarily, rated values (such as maximum ratings, operating condition ranges, or other parameters) listed in products specifications of any and all UTC products described or contained herein. UTC products are not designed for use in life support appliances, devices or systems where malfunction of these products can be reasonably expected to result in personal injury. Reproduction in whole or in part is prohibited without the prior written consent of the copyright owner. The information presented in this document does not form part of any quotation or contract, is believed to be accurate and reliable and may be changed without notice.