

# PRODUCT SPECIFICATION

DATE:05/18/2004

<b>cosmo</b> ELECTRONICS CORPORATION	SMD LED : <b>KL191YGX</b>	NO. 61L01001	REV. 1
		SHEET 1 OF 8	

## Features

**Package:** 1.6x0.8x0.6mm(0603) standard package

**Feature of the device:** extremely wide viewing angle  
; ideal for backlighting and coupling  
in light guides

**Wavelength:** 570nm(Yellow Green)

**Viewing angle:** Extremely Wide( 120° )

**Grouping parameter:** luminous intensity

**Assembly methods:** suitable for all SMT assembly  
methods

**Soldering methods:** IR reflow soldering

**Taping:** Package in 8mm tape on 7" diameter reel

## Applications

**Automotive :** Dashboards , stop lamps , turn signals

**Backlighting :** LCDs , Key pads , advertising

**Status indicators :** Consumer , Key pads , advertising

## Package Dimensions

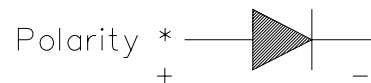
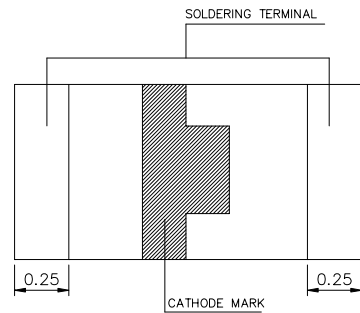
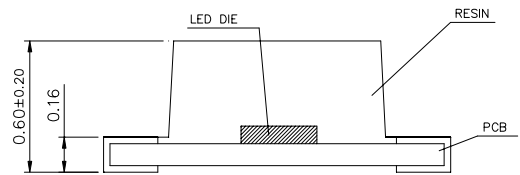
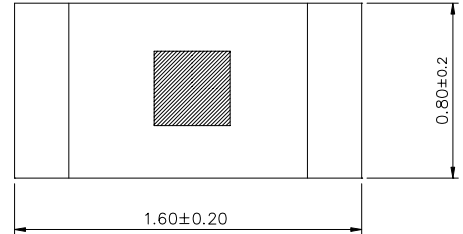

## Absolute Maximum Ratings (Ta=25°C)

Parameter	Symbol	Spec	Unit
Reverse Voltage	VR	5	V
Forward Current	IF	30	mA
Operating Temperature	Top	-25~+80	°C
Storage Temperature	Tstg	-30~+85	°C
Power Dissipation	Pd	78	mW
Peak Forward Current (Duty ≤ 1/10, t ≤ 0.1msec)	IFp	100	mA

## For reflow soldering

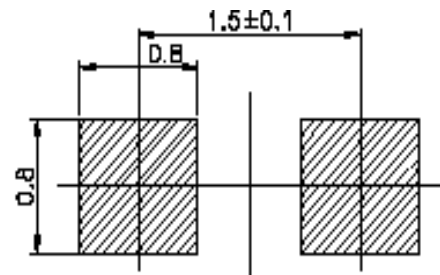

**Notes:** Tolerances Unless Dimension  
±0.1mm, Angle±0.5°, Unit=mm

# PRODUCT SPECIFICATION

DATE:05/18/2004

<b>cosmo</b> ELECTRONICS CORPORATION	SMD LED : <b>KL191YGX</b>	NO. 61L01001	REV. 1
		SHEET 2 OF 8	

## Electro-optical Characteristics at Ta=25°C

Code for parts	Lighting color	Material	Electro-optical Data (20mA)				Wavelength (nm) typ			Reverse Current IR(uA)@VR=5V
			Vf		Iv		λ d	λ p	Δ λ	
			Typ.	Max	Min	Typ.				
KL-191YGX	Yellow Green	GaP	2.2	2.6	6	15	570	568	30	100

## The Reliability criteria of SMD LED

Item	Symbol	Test Condition	Limit	
			Min	Max
Forward Voltage	VF	IF=10mA	–	U.S.L*1.2
Reverse Current	IR	VR=5V	–	U.S.L*2.0
Power	PO	IF=10mA	L.S.L*0.7	–

\*U.S.L: Upper Standard Level

\*L.S.L: Lower Standard Level

## Results of Reliability Test

NO	Item	Test Condition	TestHours/ Cycles	Sample NO	Ac / Re
1	Temperature Cycle	H:+100°C 30min ∩ 5min L: -40°C 30min	100CYCES	11 PCS	0 / 1
2	High Temperature Storage	Temp : 100°C	500HRS	11 PCS	0 / 1
3	Low Temperature Storage	Temp : -40°C	500HRS	11 PCS	0 / 1
4	DC Operating Life	IF: 20mA	500HRS	11 PCS	0 / 1
5	High Temperature / High Humidity	60°C / 90% RH	500HRS	11 PCS	0 / 1

# PRODUCT SPECIFICATION

DATE:05/18/2004

<b>cosmo</b> ELECTRONICS CORPORATION	SMD LED : <b>KL191YGX</b>	NO. 61L01001	REV. 1
		SHEET 3 OF 8	

## Typical Electro-Optical Characteristics Curves

Relative spektrale Emission  $I_{rel}=f(\lambda)$ ,  $T_a=25^\circ\text{C}$ ,  $I_F=10\text{mA}$

$V(\lambda)$ =Standard eye response curve

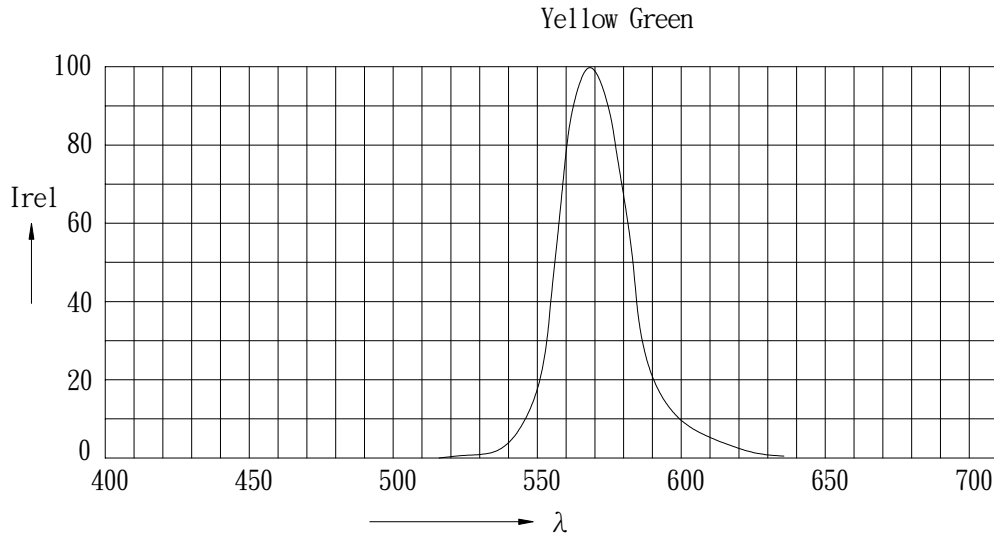

Forward Current  $I_F=f(V_F)$ ,  $T_A=25^\circ\text{C}$

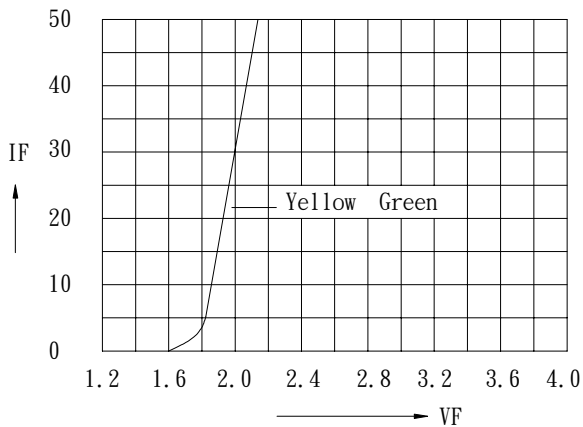

Relative Luminous Intensity  $I_v/I_v(10\text{mA})=f(I_F)$   
 $T_A=25^\circ\text{C}$

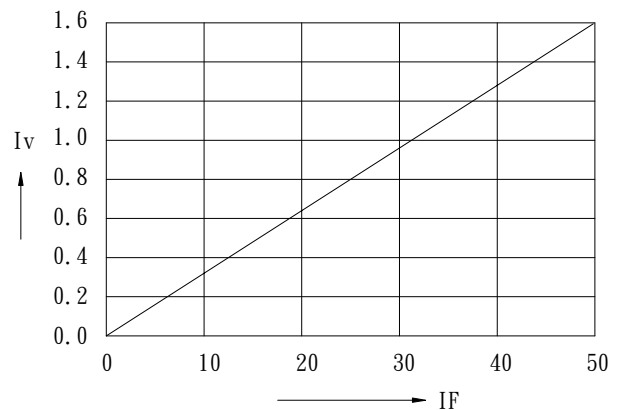

# PRODUCT SPECIFICATION

DATE:05/18/2004

<b>cosmo</b> ELECTRONICS CORPORATION	SMD LED : <b>KL191YGX</b>	NO. 61L01001	REV. 1
		SHEET 4 OF 8	

Max. Permissible Forward Current  $I_F=f(T_a)$

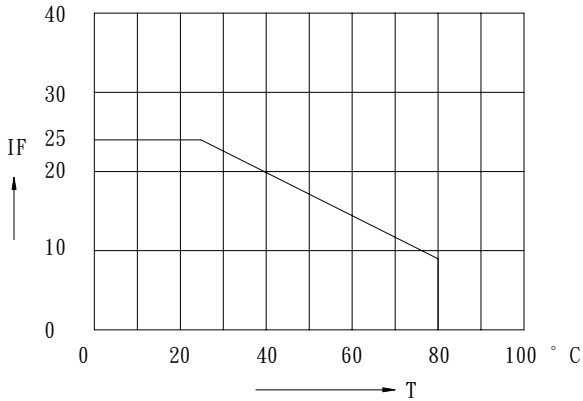

Radiation Characteristic  $I_{rel}=f(\phi)$

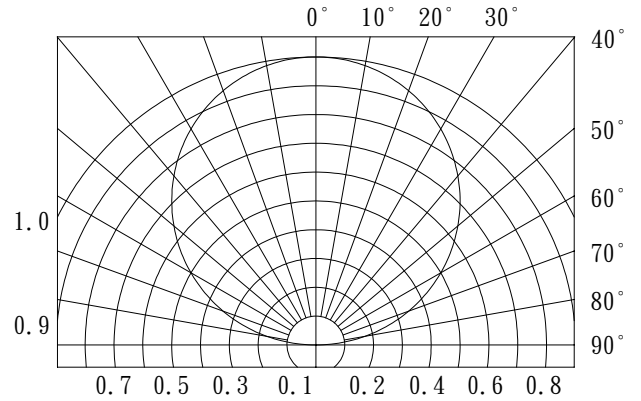

## Method of Taping / Polarity and Orientation

Packing unit 3000/reel

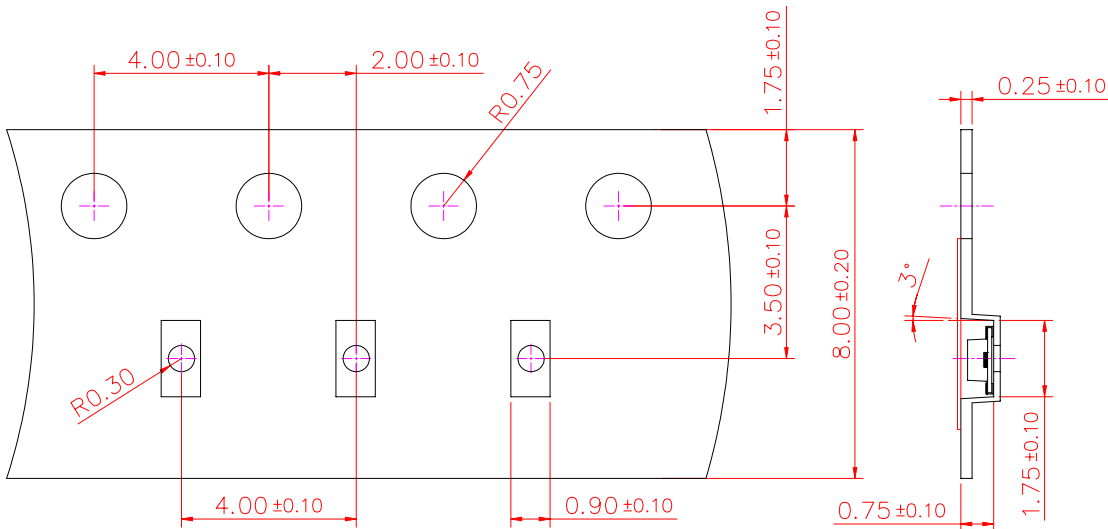

Unit : mm

Direction

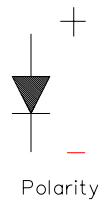
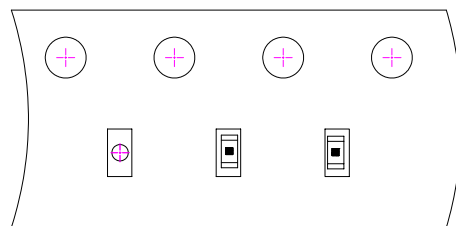
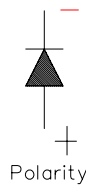
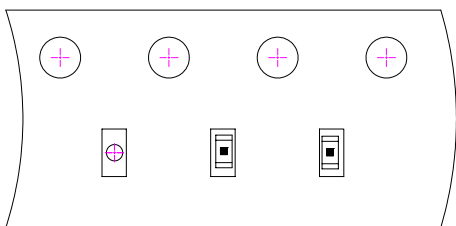

U: Taping upward

D: Taping downward

Notes: All dimensions are in millimeters (inches)

# PRODUCT SPECIFICATION

DATE:05/18/2004

<b>cosmo</b> ELECTRONICS CORPORATION	SMD LED : <b>KL191YGX</b>	NO. 61L01001	REV. 1
		SHEET 5 OF 8	

## Package Dimensions of Reel

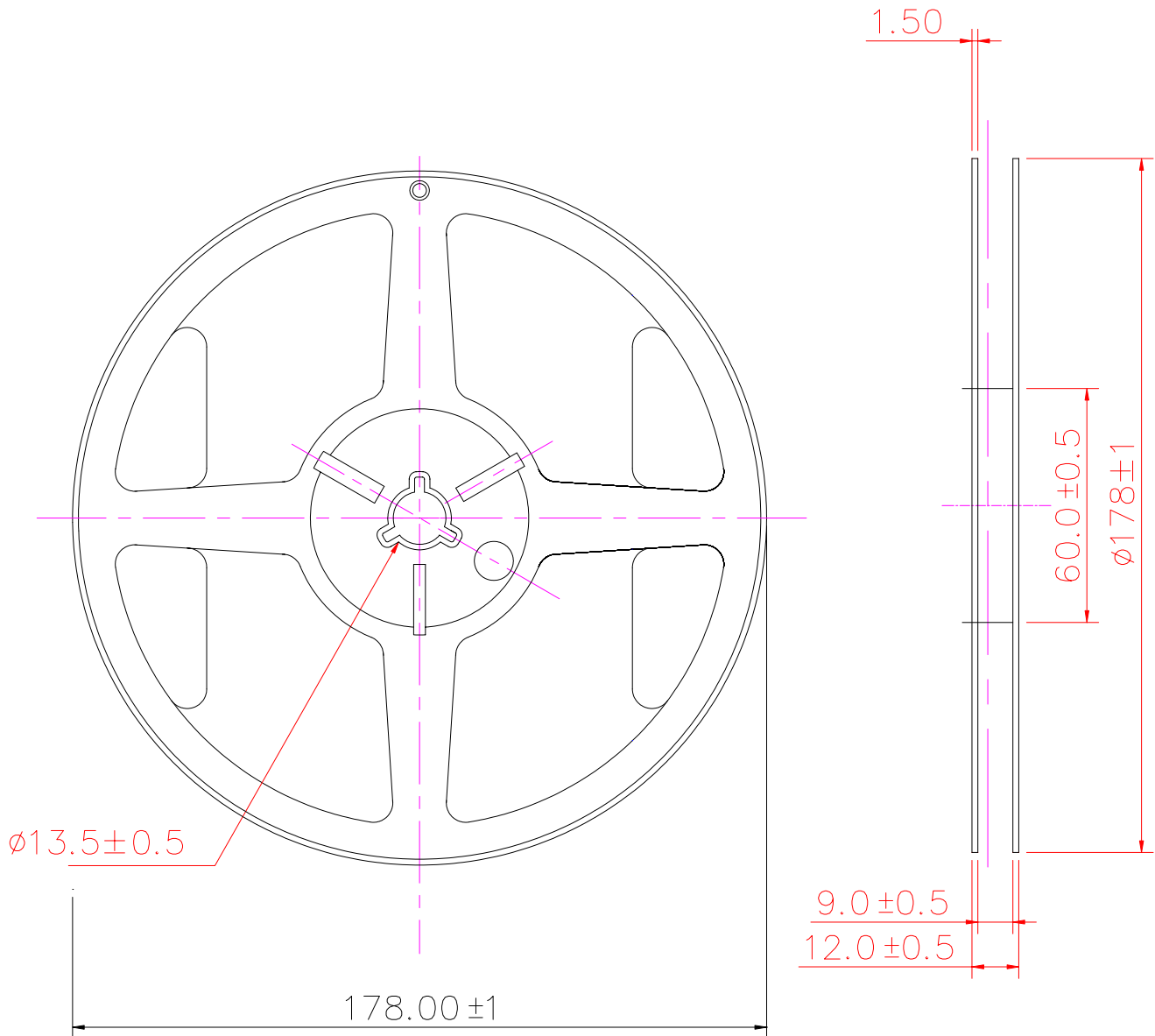

Unit: mm

# PRODUCT SPECIFICATION

DATE:05/18/2004

<b>cosmo</b> ELECTRONICS CORPORATION	SMD LED : <b>KL191YGX</b>	NO. 61L01001	REV. 1
		SHEET 6 OF 8	

## Packaging

## Product lable

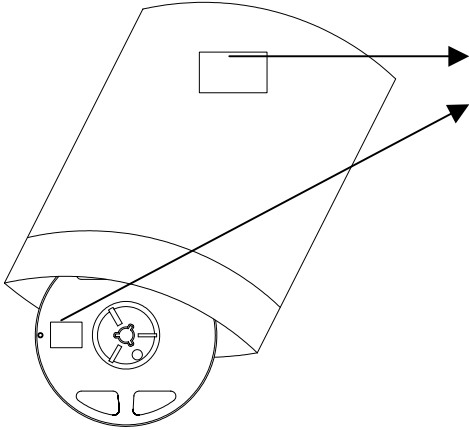

CUSTOMER:  
CUSTOMER P/N:  
DEVICE TYPE:  
BIN:  
COLOR RANK:  
LOT NO:  
QTY:

CAUTION: After open the aluminum laminate bag the lamps should be storage in the Follow condition

Temperautre:5 to 30 °C ,Humidity:70%,Storage time:72hrs max

Backing condition :If backing is necessary , we recommended the backing condition is 60 +/- 5°C 10hours

## Packing

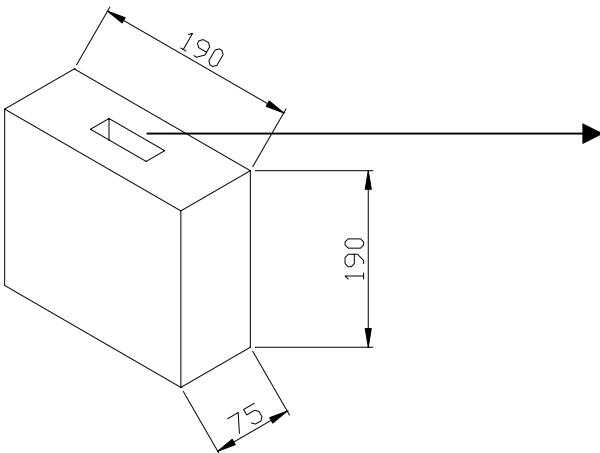

CUSTOMER:  
CUSTOMER P/N:  
DEVICE TYPE:  
BIN:  
COLOR RANK:  
LOT NO:  
QTY:

# PRODUCT SPECIFICATION

DATE:05/18/2004

<b>cosmo</b> ELECTRONICS CORPORATION	SMD LED : <b>KL191YGX</b>	NO. 61L01001	REV. 1
		SHEET 7 OF 8	

## Cautions for use

Over-current-proof

Customer must apply resistors for protection ,others slight voltage shit will cause big current change (Burn out will happen).

Storage time

The operation of temperature and RH are :  $5^{\circ}\text{C}\sim 35^{\circ}\text{C}$  ,RH60%.

Once the package is opened , the products should be used within a week.

Otherwise , they should be kept in a damp proof box with descanting agent.

Considering the tape life , we suggest our customers to use our products within a year(from production date) If opened more than one week in an atmosphere  $5^{\circ}\text{C}\sim 35^{\circ}\text{C}$  , RH60% , they should be treated at  $60^{\circ}\text{C} \pm 5^{\circ}\text{C}$  for 15 hrs.

COSMO-Innotek will not be held responsible for any damage to the user that may result from accidents or any other reasons during operation of the user's unit if use to exceed the absolute maximum ratings, or not keep the matters that demand special attention.

## Others

Soldering Heat Reliability

Available for Pb free soldering process

Please refer to the following figure :

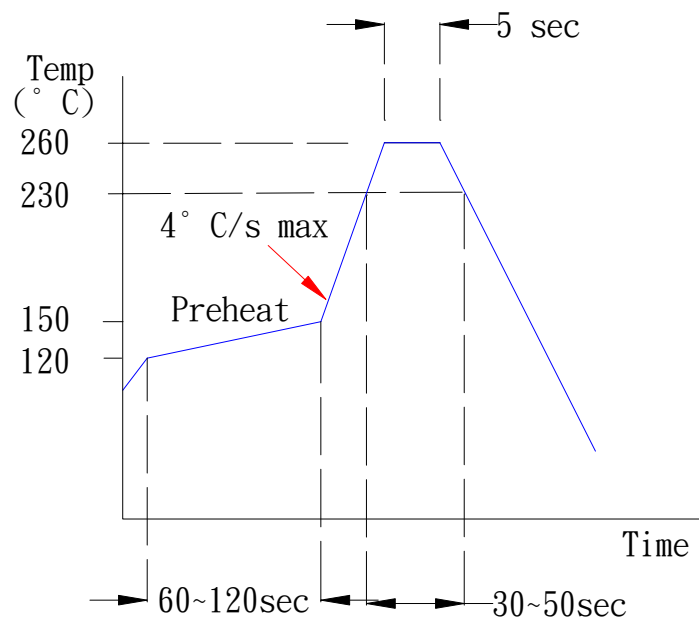

# PRODUCT SPECIFICATION

DATE:05/18/2004

<b>cosmo</b> ELECTRONICS CORPORATION	SMD LED : <b>KL191YGX</b>	NO. 61L01001	REV. 1
		SHEET 8 OF 8	

## Soldering Iron

Basic spec is  $\leq 5$ sec when  $260^{\circ}\text{C}$ . If temperature is higher, time shorter (  $+10^{\circ}\text{C} \rightarrow -1$ sec ).  
Power dissipation of Iron should be smaller than 15W, and temperature should be controllable.  
Surface temperature of the device should be under  $230^{\circ}\text{C}$ .

## Rework

Customer must finish rework within 5sec under  $245^{\circ}\text{C}$ .  
The head of Iron can not touch copper foil.  
Twin-head type is preferred.

