

Low Power Consumption, CMOS LDO

WL2805N Series

■ Features

- Quiescent current : 3 μ A Typ.
- Input voltage : 2.3V ~ 5.5V
- Output voltage : 1.2V ~ 3.3V
- Output current : 250mA @ $V_{OUT} > 2V$
- Output current : 100mA @ $V_{OUT} \leq 2V$
- Dropout voltage : 100mV @ 100mA
- Recommend capacitor : 1 μ F

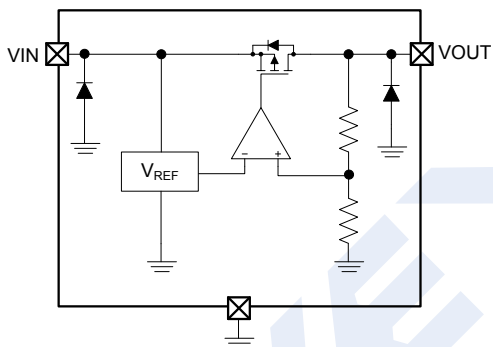
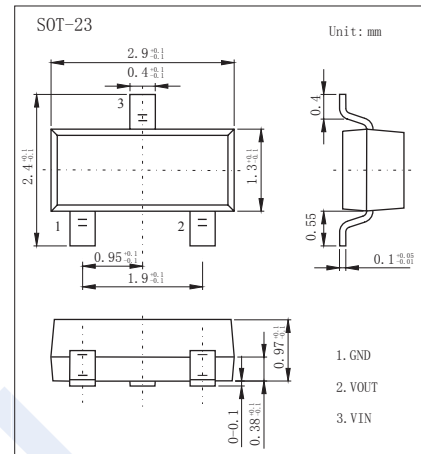

■ Absolute Maximum Ratings $T_a = 25^\circ\text{C}$

Parameter	Symbol	Rating	Unit
Input Voltage Range	V_{IN}	-0.3 to 6	V
Input Voltage	V_{IN}	2.3 to 5.5	
V_{EN} Range	V_{EN}	-0.3 to V_{IN}	
Output Voltage Range	V_{OUT}	-0.3 to V_{IN}	mW
Power Dissipation	P_{GM}	300	
Thermal Resistance Junction to Ambient	R_{thJA}	417	$^\circ\text{C}/\text{W}$
Lead Temperature	T_L	260	$^\circ\text{C}$
Operating Temperature Range	T_{OPR}	-40 to 85	
Junction Temperature	T_J	150	
Storage Temperature Range	T_{stg}	-55 to 150	

Low Power Consumption, CMOS LDO

WL2805N Series

■ Electrical Characteristics ($V_{IN} = V_{OUT} + 1V$, $C_{IN}=C_{OUT}=1\mu F$, $T_a=25^\circ C$, unless otherwise noted)

Parameter	Symbol	Test Conditions	Min	Typ.	Max	Unit
Output Voltage	WL2805N12	$V_{IN} = V_{OUT} + 1V$, $I_{OUT}=1mA$	1.17	1.2	1.23	V
	WL2805N13		1.27	1.3	1.33	
	WL2805N15		1.47	1.5	1.53	
	WL2805N18		1.764	1.8	1.836	
	WL2805N25		2.45	2.5	2.55	
	WL2805N28		2.744	2.8	2.856	
	WL2805N30		2.94	3	3.06	
	WL2805N33		3.234	3.3	3.366	
Dropout Voltage	V_{DROP}	$I_{OUT} = 30mA$, $V_{OUT}=3V$		30	100	mV
		$I_{OUT} = 100mA$, $V_{OUT}=3V$		100	200	
Load Regulation	ΔV_{LOAD}	$I_{OUT} = 1\sim 100mA$		25		
Line Regulation	ΔV_{LINE}	$V_{IN}=V_{OUT}+1V\sim 6V$, $I_{OUT}=40mA$			0.1	%/V
Output Current	I_{OUT}	$V_{OUT} > 2V$			250	mA
		$V_{OUT} \leq 2V$			100	
Output short current limiter	I_{LIM}	$V_{OUT}=GND$		150		
Quiescent Current	I_Q	$V_{IN} = V_{OUT} + 1V$, $I_{OUT}=0A$		3	5	μA
Power Supply Ripple Rejection	PSRR	$V_p-p=1V$, $F=100Hz$, $I_{OUT}=10mA$		-50		dB
		$V_p-p=1V$, $F=1KHz$, $I_{OUT}=10mA$		-30		

■ Marking

NO	WL2805N12	WL2805N13	WL2805N15	WL2805N18
Marking	F12*	F13*	F15*	F18*

NO	WL2805N25	WL2805N28	WL2805N30	WL2805N33
Marking	F25*	F28*	F30*	F33*

■ Typical Applications

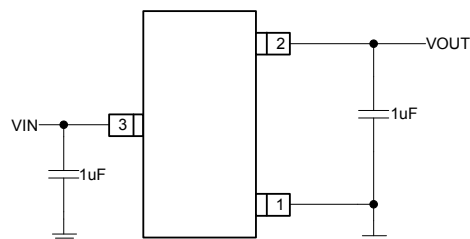

Low Power Consumption, CMOS LDO

WL2805N Series

■ Typical Characteristics

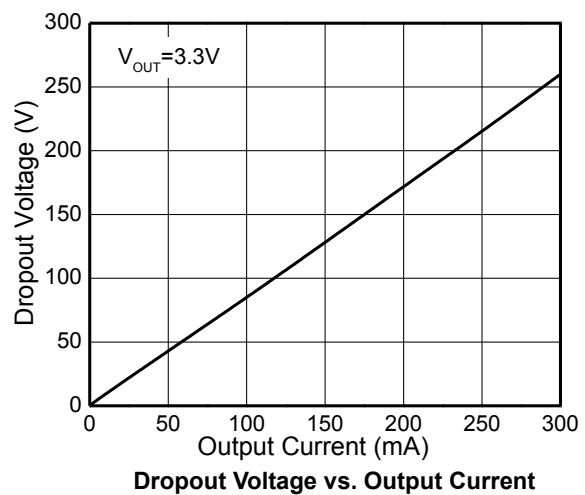
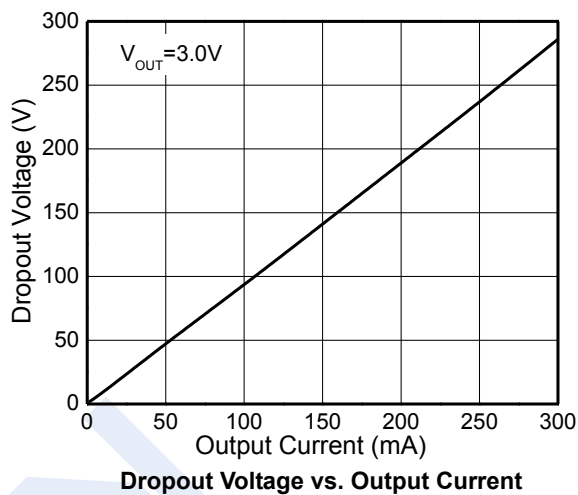
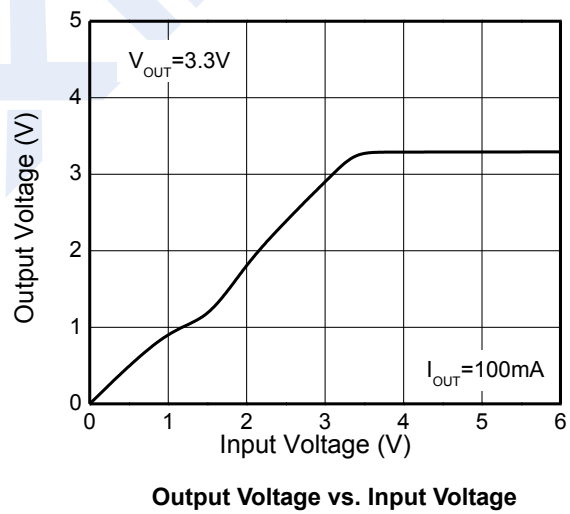
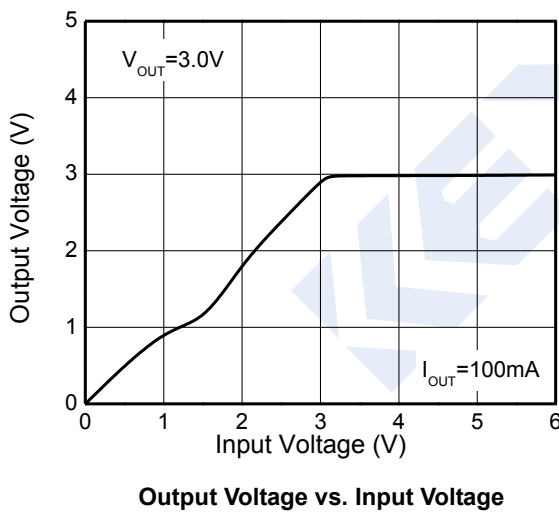
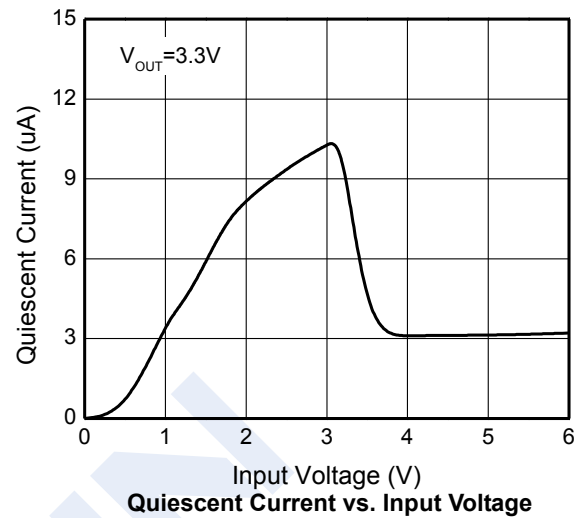
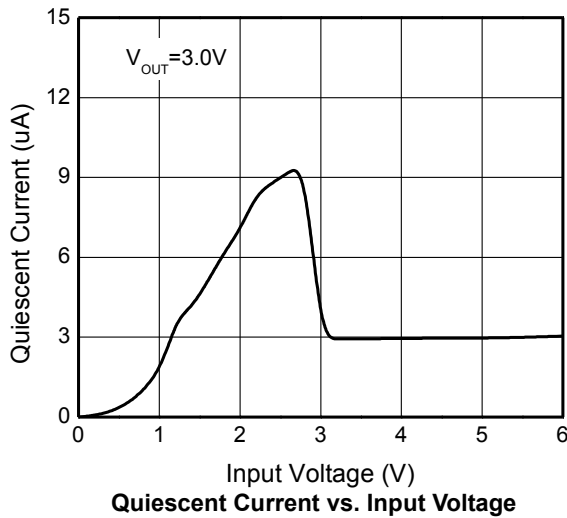

Low Power Consumption, CMOS LDO

WL2805N Series

■ Typical Characteristics

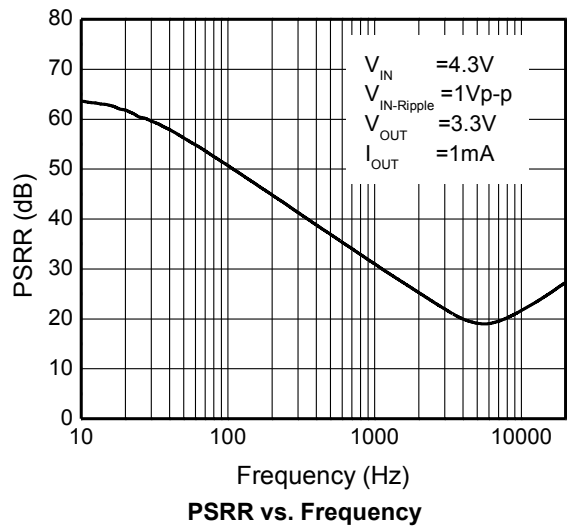
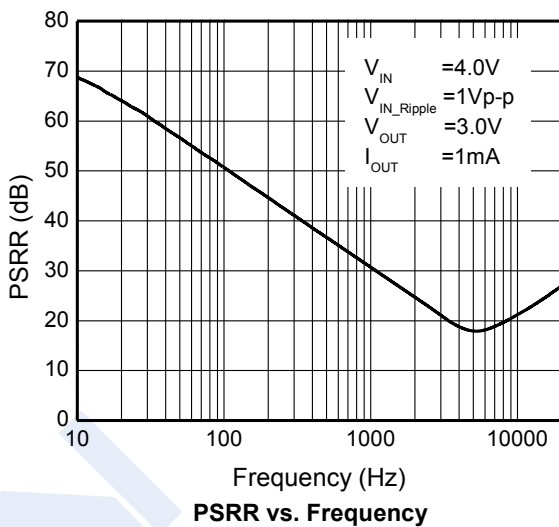
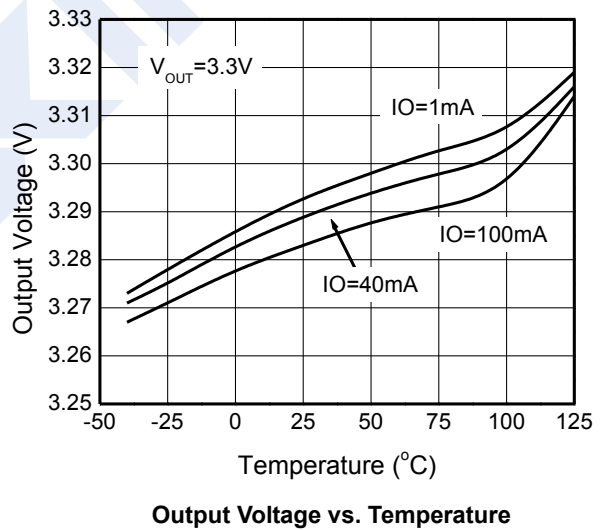
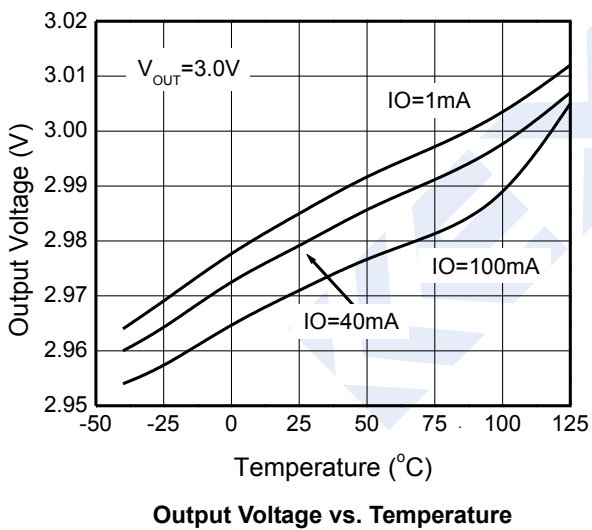
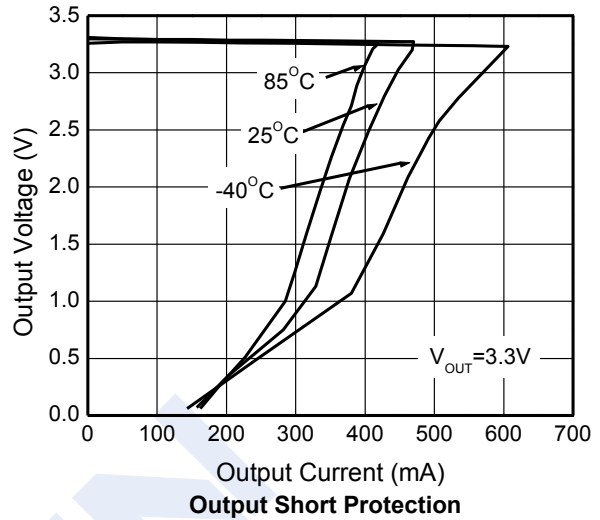
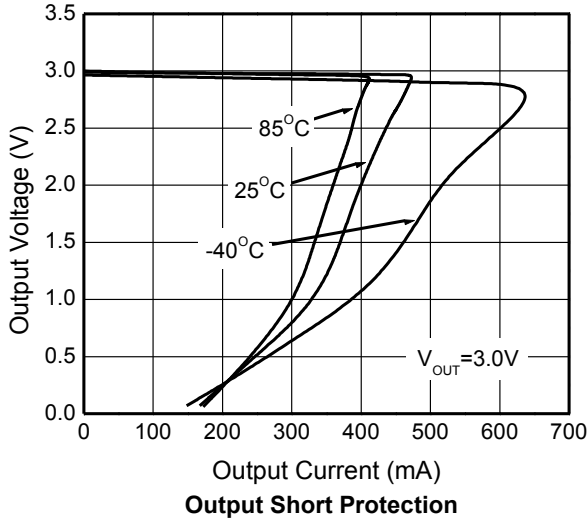

Low Power Consumption, CMOS LDO

WL2805N Series

■ Typical Characteristics

