

## Dual Enhancement Mode MOSFET (N- and P-Channel)

### Features

- N-Channel  
20V/8A,  
 $R_{DS(ON)} = 22m\Omega (typ.) @ V_{GS} = 4.5V$   
 $R_{DS(ON)} = 30m\Omega (typ.) @ V_{GS} = 2.5V$
- P-Channel  
-20V/-4.3A,  
 $R_{DS(ON)} = 80m\Omega (typ.) @ V_{GS} = -4.5V$   
 $R_{DS(ON)} = 105m\Omega (typ.) @ V_{GS} = -2.5V$
- Super High Dense Cell Design
- Reliable and Rugged
- Lead Free and Green Devices Available  
(RoHS Compliant)

### Applications

- Power Management in Notebook Computer, Portable Equipment and Battery Powered Systems.

### Pin Description

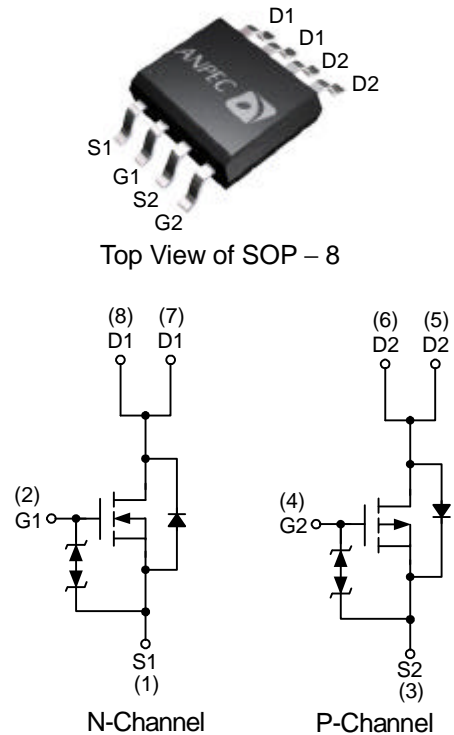

### Ordering and Marking Information

<p>APM4500A <span style="font-family: monospace;">□□-□□□</span></p> <ul style="list-style-type: none"> <li>□ Assembly Material</li> <li>□ Handling Code</li> <li>□ Temp. Range</li> <li>□ Package Code</li> </ul>	<p>Package Code K : SOP-8</p> <p>Operating Junction Temp. Range C : -55 to 150 °C</p> <p>Handling Code TR : Tape &amp; Reel</p> <p>Assembly Material L : Lead Free Device G : Halogen and Lead Free Device</p>
<p>APM4500A K : <span style="border: 1px solid black; padding: 2px;">APM4500A XXXXX</span></p>	<p>XXXXX - Date Code</p>

Note: ANPEC lead-free products contain molding compounds/die attach materials and 100% matte tin plate termination finish; which are fully compliant with RoHS. ANPEC lead-free products meet or exceed the lead-free requirements of IPC/JEDEC J-STD-020C for MSL classification at lead-free peak reflow temperature. ANPEC defines "Green" to mean lead-free (RoHS compliant) and halogen free (Br or Cl does not exceed 900ppm by weight in homogeneous material and total of Br and Cl does not exceed 1500ppm by weight).

ANPEC reserves the right to make changes to improve reliability or manufacturability without notice, and advise customers to obtain the latest version of relevant information to verify before placing orders.

## Absolute Maximum Ratings $(T_A = 25^\circ\text{C}$ unless otherwise noted)

Symbol	Parameter	N Channel	P Channel	Unit
$V_{DSS}$	Drain-Source Voltage	20	-20	V
$V_{GSS}$	Gate-Source Voltage	$\pm 12$	$\pm 12$	
$I_D^*$	Continuous Drain Current	$V_{GS}=10\text{V(N)}$ 8	-4.3	A
$I_{DM}^*$	Pulsed Drain Current	$V_{GS}=-10\text{V(P)}$ 30	-16	
$I_S^*$	Diode Continuous Forward Current	2.5	-2	A
$T_J$	Maximum Junction Temperature	150		$^\circ\text{C}$
$T_{STG}$	Storage Temperature Range	-55 to 150		
$P_D^*$	Power Dissipation	$T_A=25^\circ\text{C}$	2	W
		$T_A=100^\circ\text{C}$	0.8	
$R_{\theta JA}^*$	Thermal Resistance-Junction to Ambient	62.5		$^\circ\text{C/W}$

Note:

\*Surface Mounted on  $1\text{in}^2$  pad area,  $t \leq 10\text{sec}$ .

## Electrical Characteristics $(T_A = 25^\circ\text{C}$ unless otherwise noted)

Symbol	Parameter	Test Conditions	APM4500AK			Unit	
			Min.	Typ.	Max.		
<b>Static Characteristics</b>							
$BV_{DSS}$	Drain-Source Breakdown Voltage	$V_{GS}=0\text{V}, I_{DS}=250\mu\text{A}$	N-Ch	20	-	-	V
		$V_{GS}=0\text{V}, I_{DS}=-250\mu\text{A}$	P-Ch	-20	-	-	
$I_{DSS}$	Zero Gate Voltage Drain Current	$V_{DS}=16\text{V}, V_{GS}=0\text{V}$ $T_J=85^\circ\text{C}$	N-Ch	-	-	1	$\mu\text{A}$
			P-Ch	-	-	-1	
$I_{DSS}$	Zero Gate Voltage Drain Current	$V_{DS}=-16\text{V}, V_{GS}=0\text{V}$ $T_J=85^\circ\text{C}$	N-Ch	-	-	30	
			P-Ch	-	-	-30	
$V_{GS(th)}$	Gate Threshold Voltage	$V_{DS}=V_{GS}, I_{DS}=250\mu\text{A}$	N-Ch	0.5	0.7	1	V
		$V_{DS}=V_{GS}, I_{DS}=-250\mu\text{A}$	P-Ch	-0.5	-0.75	-1	
$I_{GSS}$	Gate Leakage Current	$V_{GS}=\pm 10\text{V}, V_{DS}=0\text{V}$	N-Ch	-	-	$\pm 10$	$\mu\text{A}$
			P-Ch	-	-	$\pm 10$	
$R_{DS(ON)}^a$	Drain-Source On-State Resistance	$V_{GS}=4.5\text{V}, I_{DS}=8\text{A}$	N-Ch	-	22	26	$\text{m}\Omega$
		$V_{GS}=-4.5\text{V}, I_{DS}=-4.3\text{A}$	P-Ch	-	80	90	
		$V_{GS}=2.5\text{V}, I_{DS}=5.2\text{A}$	N-Ch	-	30	36	
		$V_{GS}=-2.5\text{V}, I_{DS}=-2\text{A}$	P-Ch	-	105	115	

## Electrical Characteristics (Cont.) ( $T_A = 25^\circ\text{C}$ unless otherwise noted)

Symbol	Parameter	Test Conditions	APM4500AK			Unit		
			Min.	Typ.	Max.			
<b>Diode Characteristics</b>								
$V_{SD}^a$	Diode Forward Voltage	$I_{SD}=2.5A, V_{GS}=0V$	N-Ch	-	0.8	1.3	V	
		$I_{SD}=-2A, V_{GS}=0V$	P-Ch	-	-0.7	-1.3		
$t_{rr}$	Reverse Recovery Time	N-Channel $I_{SD}=-8A, di_{SD}/dt = 100A/\mu s$	N-Ch	-	15	-	ns	
			P-Ch	-	22	-		
$q_{rr}$	Reverse Recovery Charge	P-Channel $I_{SD}=-4.3A, di_{SD}/dt = 100A/\mu s$	N-Ch	-	7	-	nC	
			P-Ch	-	6	-		
<b>Dynamic Characteristics<sup>b</sup></b>								
$R_G$	Gate Resistance	$V_{GS}=0V, V_{DS}=0V, F=1MHz$	N-Ch	-	4	-	$\Omega$	
			P-Ch	-	9	-		
$C_{iss}$	Input Capacitance	N-Channel $V_{GS}=0V,$ $V_{DS}=10V,$ Frequency=1.0MHz	N-Ch	-	740	-	pF	
$C_{oss}$	Output Capacitance		P-Ch	-	565	-		
$C_{rss}$	Reverse Transfer Capacitance	P-Channel $V_{GS}=0V,$ $V_{DS}=-10V,$ Frequency=1.0MHz	N-Ch	-	160	-		
			P-Ch	-	125	-		
$t_{d(ON)}$	Turn-on Delay Time	N-Channel $V_{DD}=10V, R_L=10\Omega,$ $I_{DS}=1A, V_{GEN}=4.5V,$ $R_G=6\Omega$	N-Ch	-	5	10	ns	
			P-Ch	-	6	12		
$t_r$	Turn-on Rise Time		N-Ch	-	11	21		
			P-Ch	-	13	24		
$t_{d(OFF)}$	Turn-off Delay Time		P-Channel $V_{DD}=-10V, R_L=10\Omega,$ $I_{DS}=-1A, V_{GEN}=-4.5V,$ $R_G=6\Omega$	N-Ch	-	40		73
				P-Ch	-	34		62
$t_f$	Turn-off Fall Time	N-Ch	-	23	42			
		P-Ch	-	32	59			
<b>Gate Charge Characteristics<sup>b</sup></b>								
$Q_g$	Total Gate Charge	N-Channel $V_{DS}=10V, V_{GS}=4.5V,$ $I_{DS}=8A$	N-Ch	-	10	13	nC	
			P-Ch	-	6	8		
$Q_{gs}$	Gate-Source Charge	P-Channel $V_{DS}=-10V, V_{GS}=-4.5V,$ $I_{DS}=-4.3A$	N-Ch	-	1	-		
			P-Ch	-	1	-		
$Q_{gd}$	Gate-Drain Charge	N-Ch	-	4	-			
		P-Ch	-	2.2	-			

Notes:

a : Pulse test ; pulse width  $\leq 300\mu s$ , duty cycle  $\leq 2\%$ .

b : Guaranteed by design, not subject to production testing.

## Typical Characteristics

### N-Channel

Power Dissipation

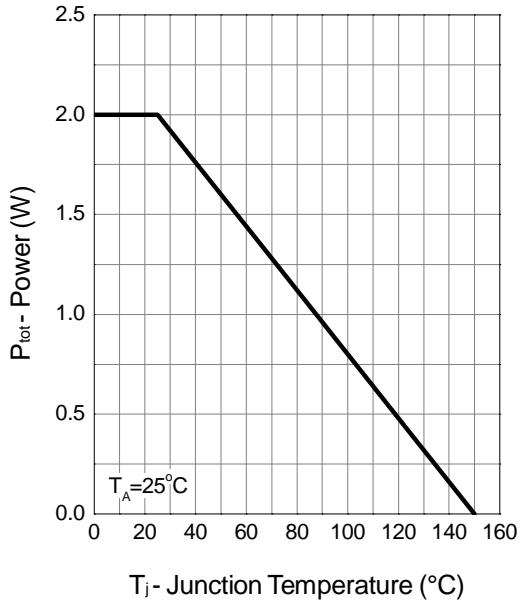

Drain Current

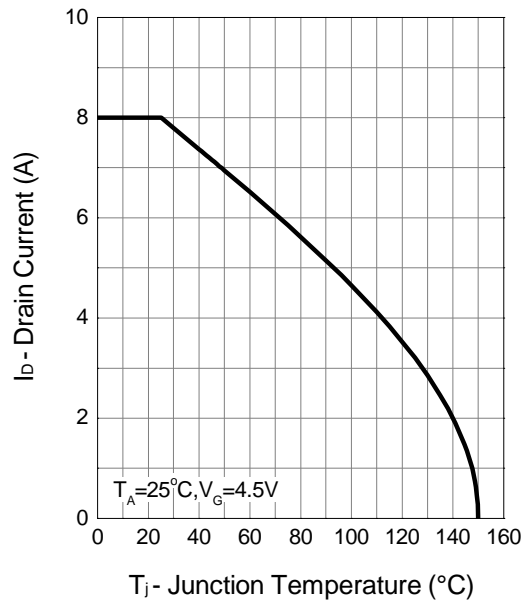

Safe Operation Area

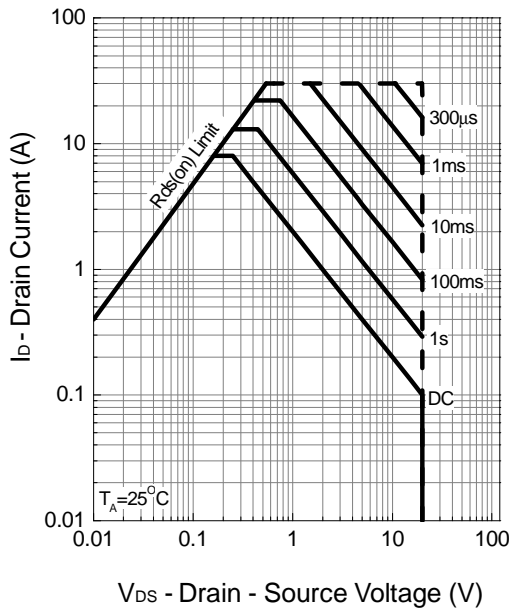

Thermal Transient Impedance

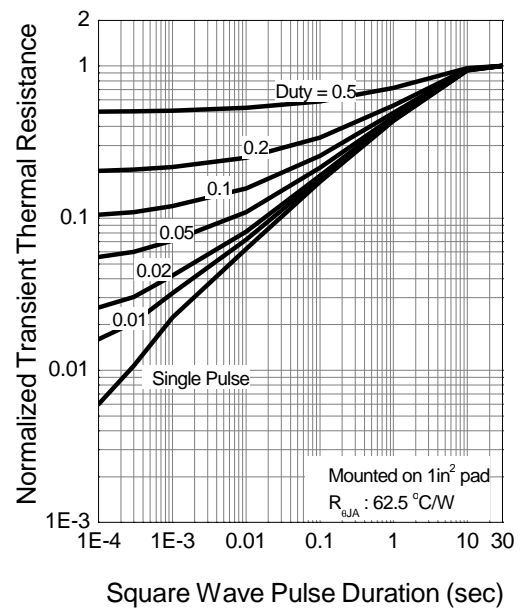

## Typical Characteristics (Cont.)

### N-Channel

Output Characteristics

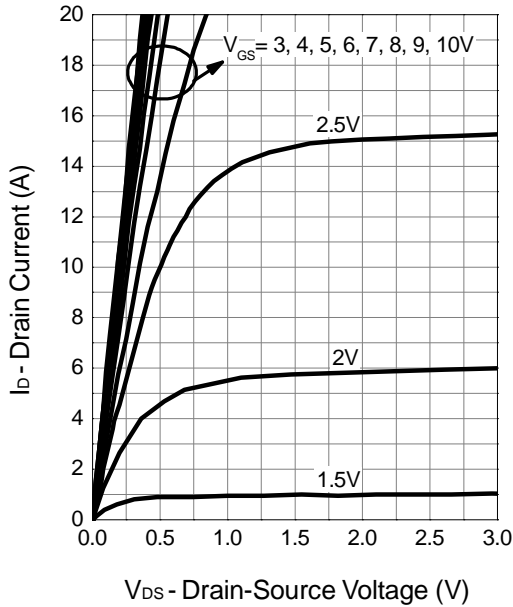

Drain-Source On Resistance

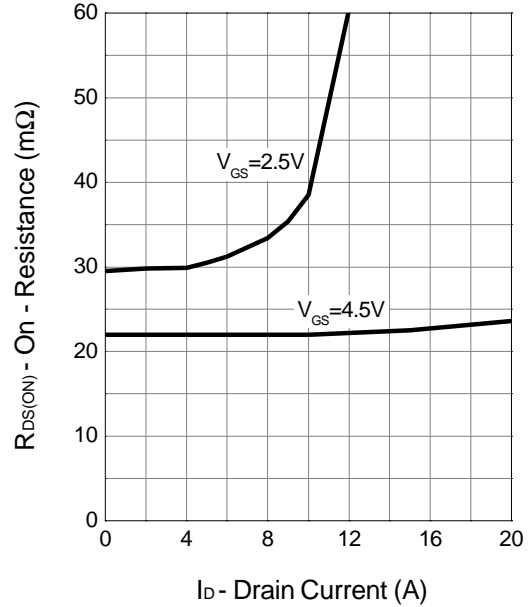

Drain-Source On Resistance

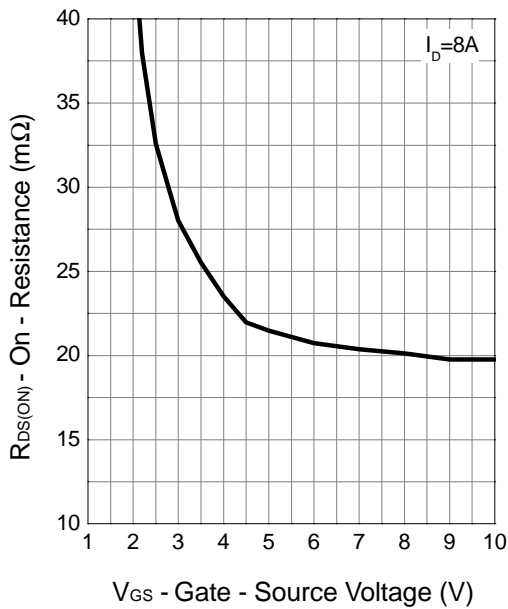

Gate Threshold Voltage

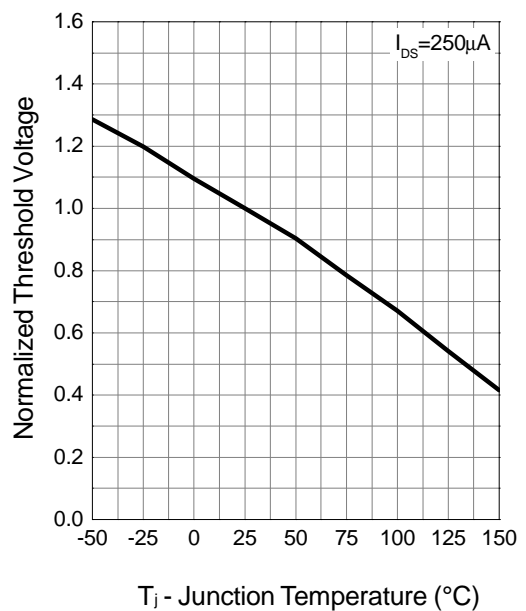

## Typical Characteristics (Cont.)

### N-Channel

Drain-Source On Resistance

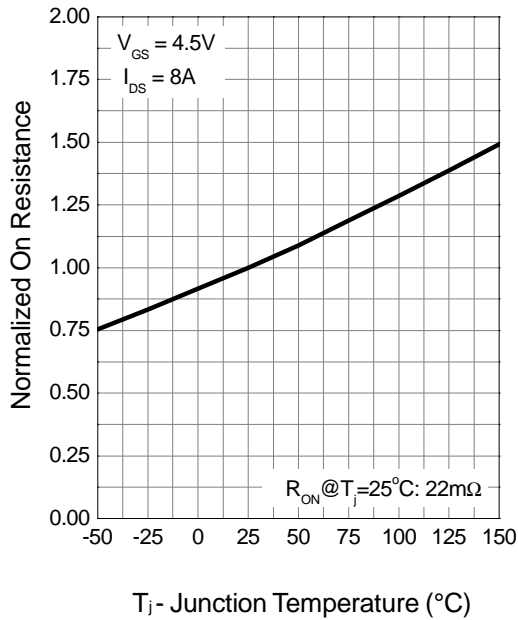

Source-Drain Diode Forward

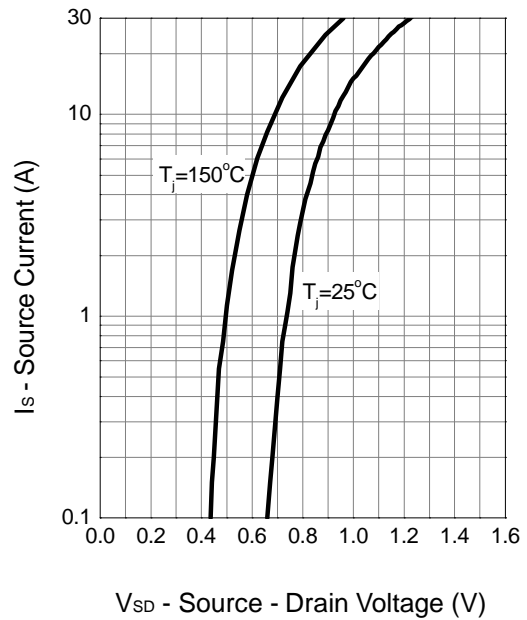

Capacitance

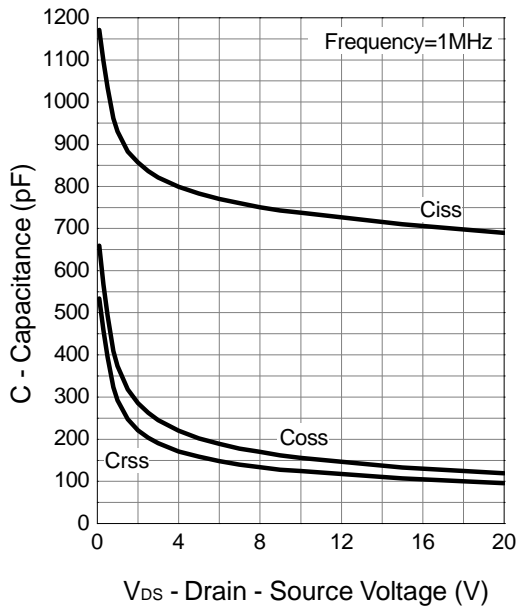

Gate Charge

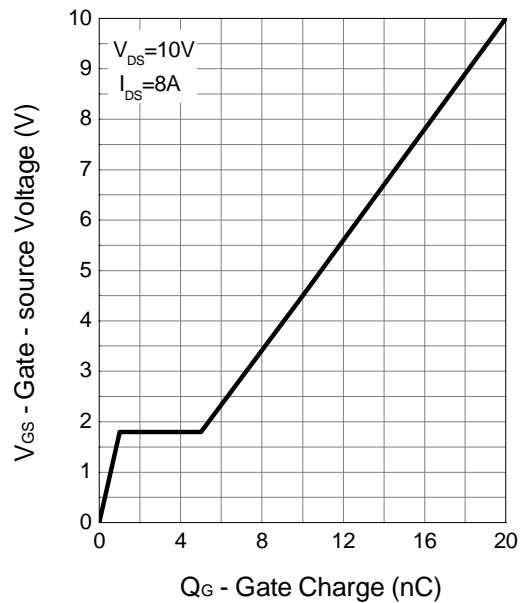

Typical Characteristics (Cont.)

P-Channel

Power Dissipation

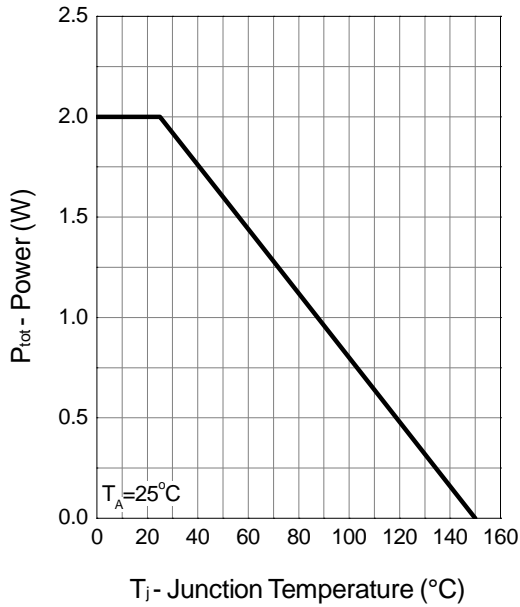

Drain Current

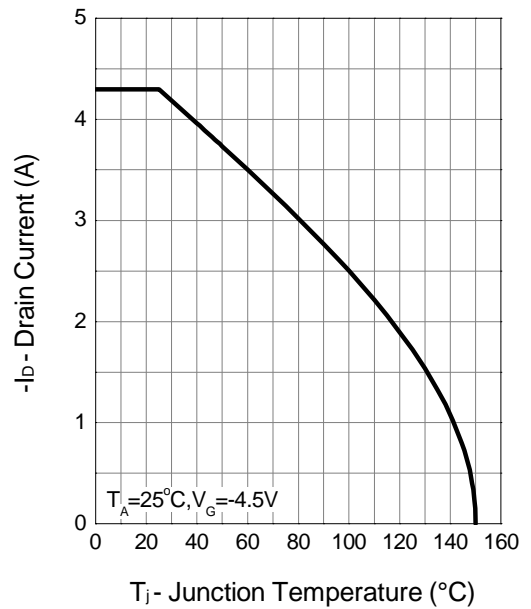

Safe Operation Area

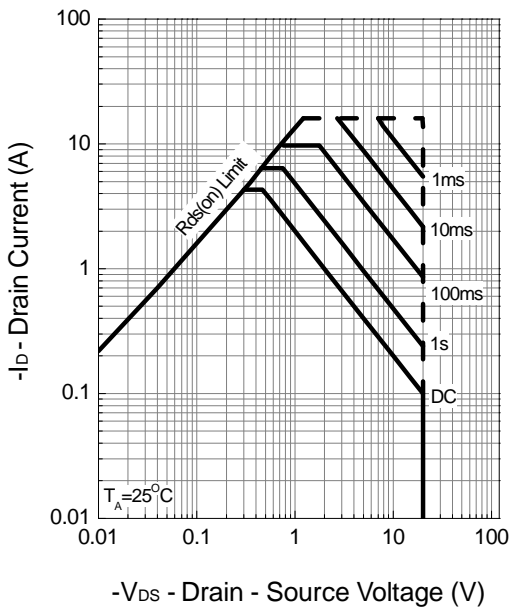

Thermal Transient Impedance

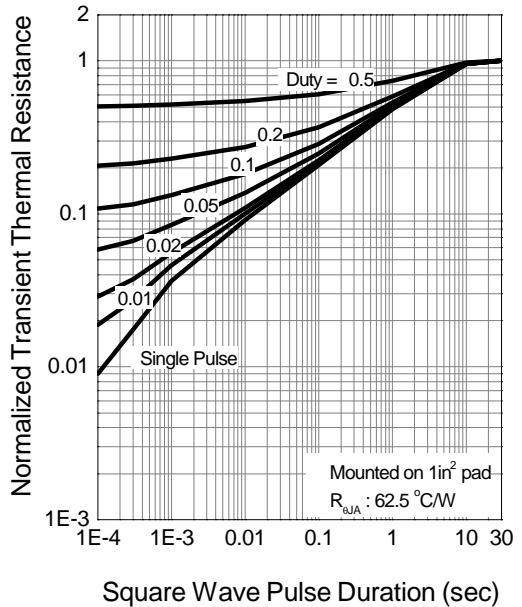

## Typical Characteristics (Cont.)

### P-Channel

Output Characteristics

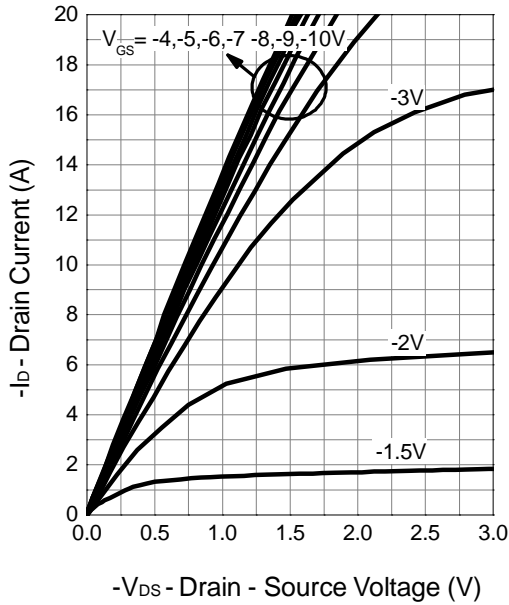

Drain-Source On Resistance

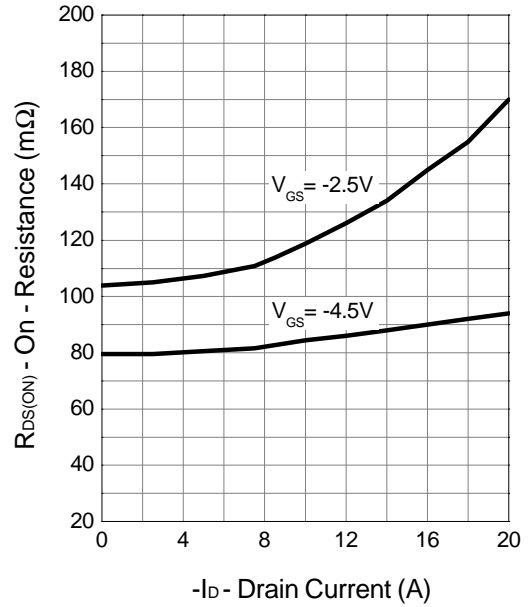

Drain-Source On Resistance

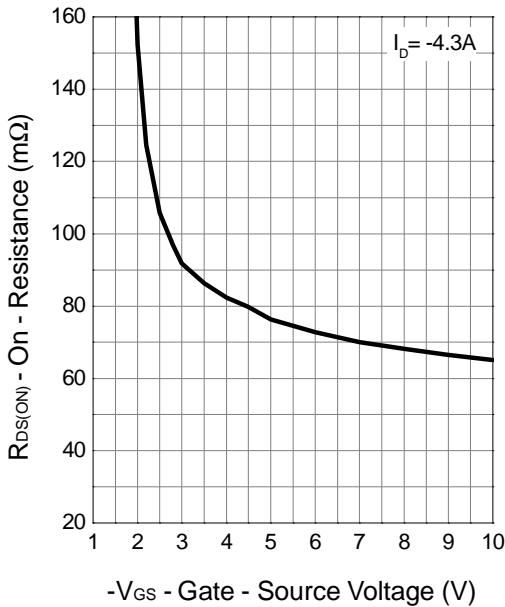

Gate Threshold Voltage

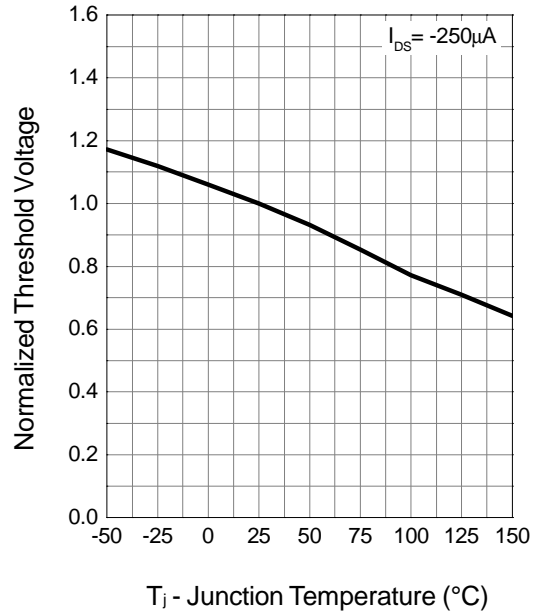



Typical Characteristics (Cont.)

P-Channel

Drain-Source On Resistance

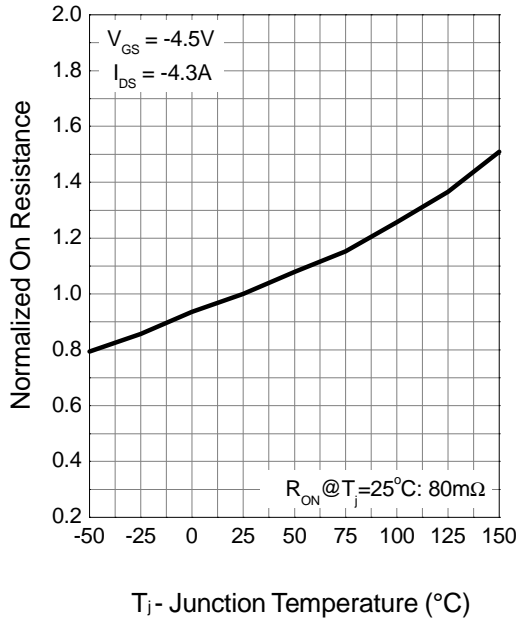

Source-Drain Diode Forward

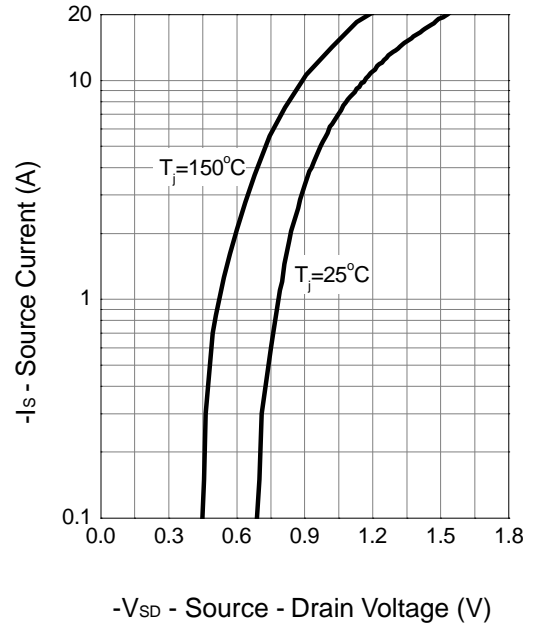

Capacitance

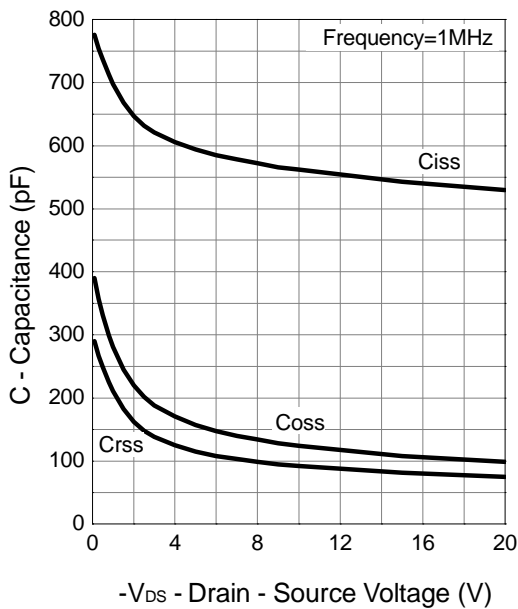

Gate Charge

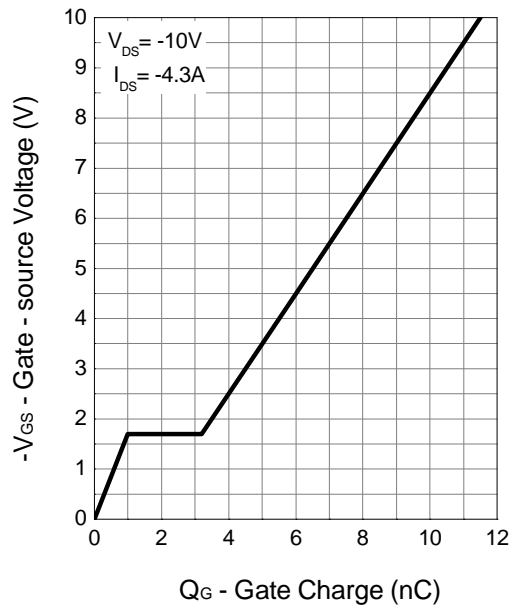

Package Information

SOP-8

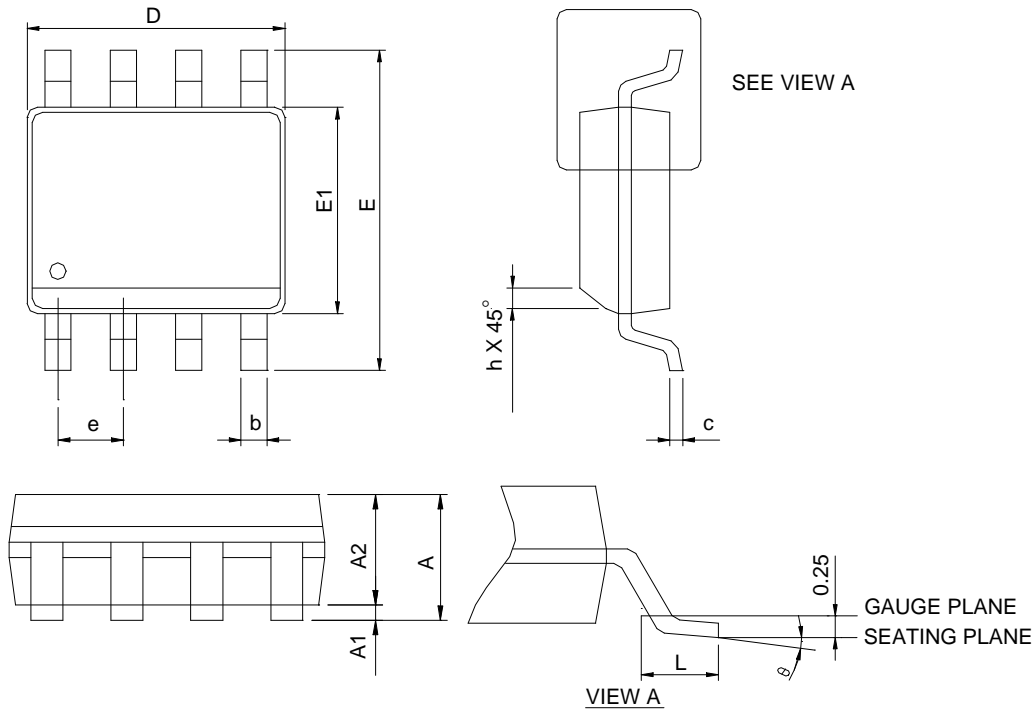

SYMBOL	SOP-8			
	MILLIMETERS		INCHES	
	MIN.	MAX.	MIN.	MAX.
A		1.75		0.069
A1	0.10	0.25	0.004	0.010
A2	1.25		0.049	
b	0.31	0.51	0.012	0.020
c	0.17	0.25	0.007	0.010
D	4.80	5.00	0.189	0.197
E	5.80	6.20	0.228	0.244
E1	3.80	4.00	0.150	0.157
e	1.27 BSC		0.050 BSC	
h	0.25	0.50	0.010	0.020
L	0.40	1.27	0.016	0.050
θ	0°	8°	0°	8°

- Note: 1. Follow JEDEC MS-012 AA.  
 2. Dimension "D" does not include mold flash, protrusions or gate burrs. Mold flash, protrusion or gate burrs shall not exceed 6 mil per side.  
 3. Dimension "E" does not include inter-lead flash or protrusions. Inter-lead flash and protrusions shall not exceed 10 mil per side.

### Carrier Tape & Reel Dimensions

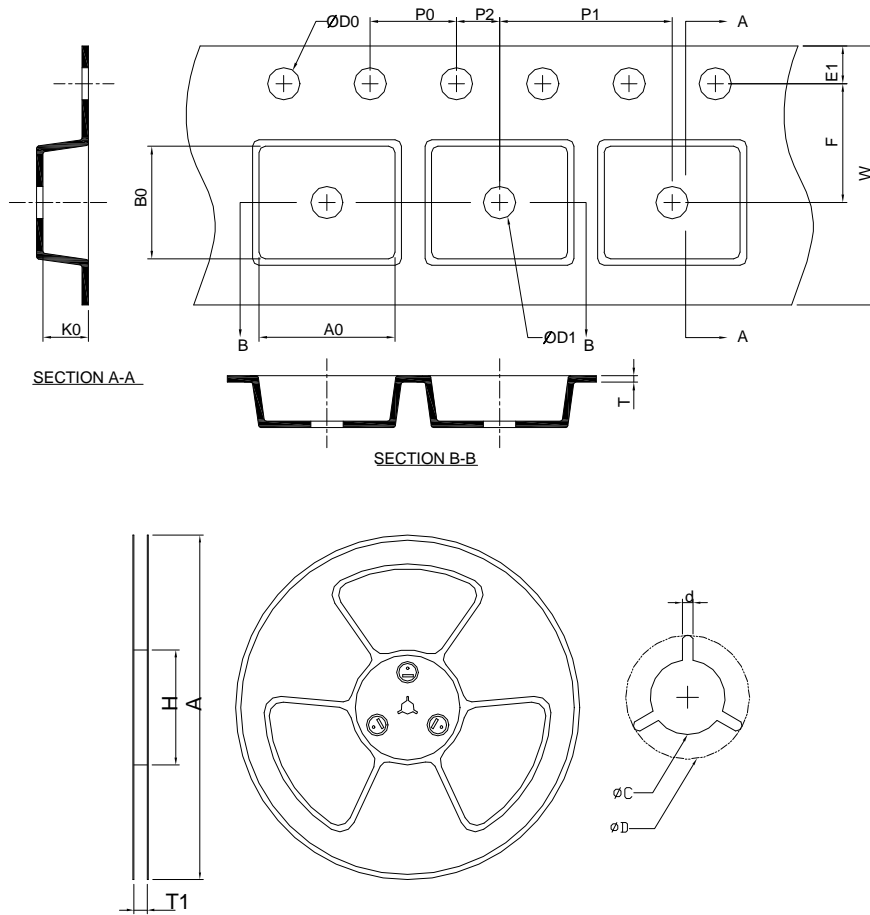

Application	A	H	T1	C	d	D	W	E1	F
SOP-8	330.0 ±2.00	50 MIN.	12.4+2.00 -0.00	13.0+0.50 -0.20	1.5 MIN.	20.2 MIN.	12.0 ±0.30	1.75 ±0.10	5.5 ±0.05
	P0	P1	P2	D0	D1	T	A0	B0	K0
	4.0 ±0.10	8.0 ±0.10	2.0 ±0.05	1.5+0.10 -0.00	1.5 MIN.	0.6+0.00 -0.40	6.40 ±0.20	5.20 ±0.20	2.10 ±0.20

(mm)

### Devices Per Unit

Package Type	Unit	Quantity
SOP-8	Tape & Reel	2500

**Reflow Condition (IR/Convection or VPR Reflow)**

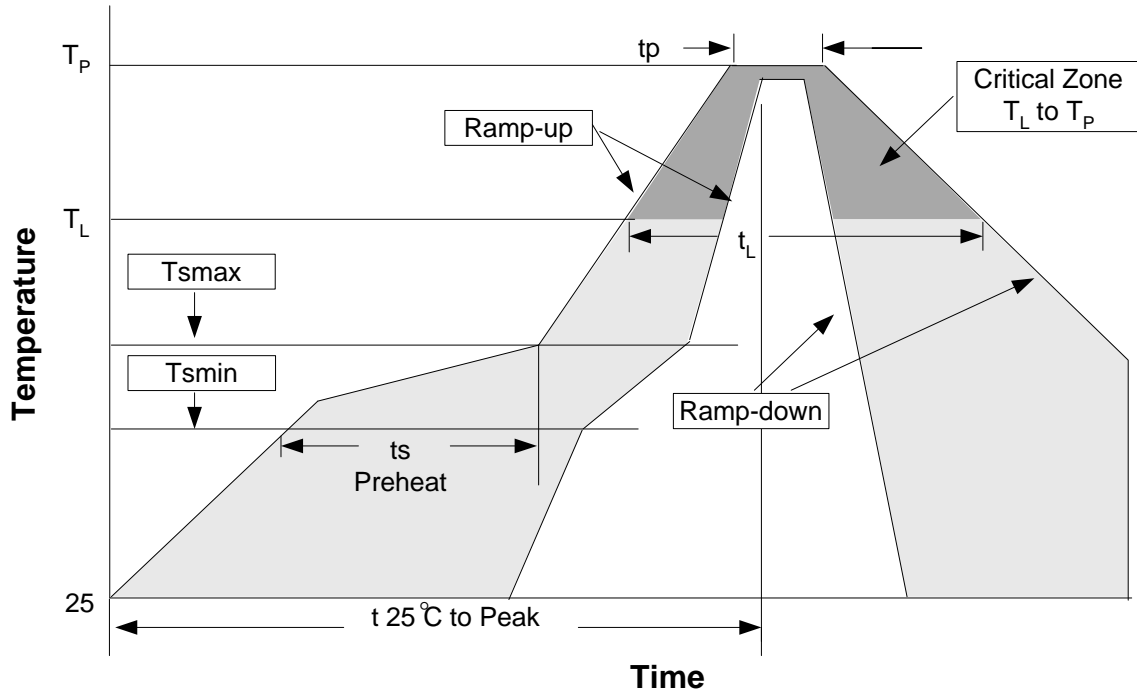

**Reliability Test Program**

Test item	Method	Description
SOLDERABILITY	MIL-STD-883D-2003	245°C, 5 sec
HOLT	MIL-STD-883D-1005.7	1000 Hrs Bias @125°C
PCT	JESD-22-B, A102	168 Hrs, 100%RH, 121°C
TST	MIL-STD-883D-1011.9	-65°C~150°C, 200 Cycles

**Classification Reflow Profiles**

Profile Feature	Sn-Pb Eutectic Assembly	Pb-Free Assembly
Average ramp-up rate (T <sub>L</sub> to T <sub>P</sub> )	3°C/second max.	3°C/second max.
Preheat		
- Temperature Min (T <sub>smin</sub> )	100°C	150°C
- Temperature Max (T <sub>smax</sub> )	150°C	200°C
- Time (min to max) (t <sub>s</sub> )	60-120 seconds	60-180 seconds
Time maintained above:		
- Temperature (T <sub>L</sub> )	183°C	217°C
- Time (t <sub>L</sub> )	60-150 seconds	60-150 seconds
Peak/Classification Temperature (T <sub>P</sub> )	See table 1	See table 2
Time within 5°C of actual Peak Temperature (t <sub>p</sub> )	10-30 seconds	20-40 seconds
Ramp-down Rate	6°C/second max.	6°C/second max.
Time 25°C to Peak Temperature	6 minutes max.	8 minutes max.

Notes: All temperatures refer to topside of the package. Measured on the body surface.

## Classification Reflow Profiles (Cont.)

Table 1. SnPb Eutectic Process – Package Peak Reflow Temperatures

Package Thickness	Volume mm <sup>3</sup> <350	Volume mm <sup>3</sup> ≥350
<2.5 mm	240 +0/-5°C	225 +0/-5°C
≥2.5 mm	225 +0/-5°C	225 +0/-5°C

Table 2. Pb-free Process – Package Classification Reflow Temperatures

Package Thickness	Volume mm <sup>3</sup> <350	Volume mm <sup>3</sup> 350-2000	Volume mm <sup>3</sup> >2000
<1.6 mm	260 +0°C*	260 +0°C*	260 +0°C*
1.6 mm – 2.5 mm	260 +0°C*	250 +0°C*	245 +0°C*
≥2.5 mm	250 +0°C*	245 +0°C*	245 +0°C*

\*Tolerance: The device manufacturer/supplier **shall** assure process compatibility up to and including the stated classification temperature (this means Peak reflow temperature +0°C. For example 260°C+0°C) at the rated MSL level.

## Customer Service

### Anpec Electronics Corp.

Head Office :

No.6, Dusing 1st Road, SBIP,

Hsin-Chu, Taiwan, R.O.C.

Tel : 886-3-5642000

Fax : 886-3-5642050

Taipei Branch :

2F, No. 11, Lane 218, Sec 2 Jhongsing Rd.,

Sindain City, Taipei County 23146, Taiwan

Tel : 886-2-2910-3838

Fax : 886-2-2917-3838