

## *Multi-line ESD/EMI Protection for Color LCD Interfaces*

**UM4701 DFN8 2.0×2.0**

**UM4711 DFN8 1.7×1.3**

**UM8701 DFN16 4.0×1.6**

**UM8711 DFN16 3.3×1.3**

### General Description

The UM4701/UM4711/UM8701/UM8711 is a (L-C) low pass filter array with integrated TVS diodes. It is designed to suppress unwanted EMI signals and provide electrostatic discharge (ESD) protection in portable electronic equipment. This device utilizes solid-state silicon-avalanche technology for superior clamping performance and DC electrical characteristics. They have been optimized for protection of color LCD and camera lines in cellular phones and other portable electronics.

The device consists of identical circuits comprised of TVS diodes for ESD protection, and a 5 pole inductor-capacitor network for EMI filtering. A typical inductor value of 19nH and a capacitor value of 12pF are used to achieve 30dB minimum attenuation from 800MHz to 2.7GHz. The TVS diodes provide effective suppression of ESD voltages in excess of ±15kV (air discharge) and ±8kV (contact discharge) per IEC 61000-4-2, level 4.

The UM4701 is in a RoHS compliant DFN8 2.0×2.0 package, the UM4711 is in a RoHS compliant DFN8 1.7×1.3 package, the UM8701 is in a RoHS compliant DFN16 4.0×1.6 package and the UM8711 is in a RoHS compliant DFN16 3.3×1.3 package. The leads are finished with lead-free. The small package makes it ideal for use in portable electronics such as cell phones, digital still cameras, and PDAs.

### Applications

- Color LCD Protection
- Cell Phone CCD Camera Lines
- Clamshell Cell Phones

### Features

- Bidirectional EMI Filter with Integrated TVS for ESD Protection
- ESD Protection to IEC 61000-4-2 (ESD) Level 4, ±15kV (air), ±8kV (contact)
- Filter performance: 30dB minimum attenuation from 800MHz to 2.7GHz
- TVS Working Voltage: 5V
- Inductor: 19nH (Typical)
- Capacitors: 12pF (Typical at  $V_R = 2.5V$ )
- Protection and filtering for multi lines  
UM4701/4711: four lines  
UM8701/8711: eight lines
- Solid-state Technology

### Ordering Information

| Part Number | Working Voltage | Packaging Type | Channel | Marking Code | Shipping Qty                  |
|-------------|-----------------|----------------|---------|--------------|-------------------------------|
| UM4701      | 5.0V            | DFN8 2.0×2.0   | 4       | ABB          | 3000pcs /7Inch<br>Tape & Reel |
| UM4711      | 5.0V            | DFN8 1.7×1.3   | 4       | AR           |                               |
| UM8701      | 5.0V            | DFN16 4.0×1.6  | 8       | 8701         |                               |
| UM8711      | 5.0V            | DFN16 3.3×1.3  | 8       | 8711         |                               |

## Pin Configurations

## Top View

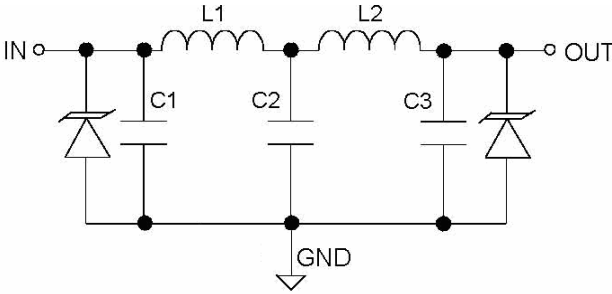
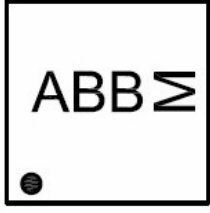
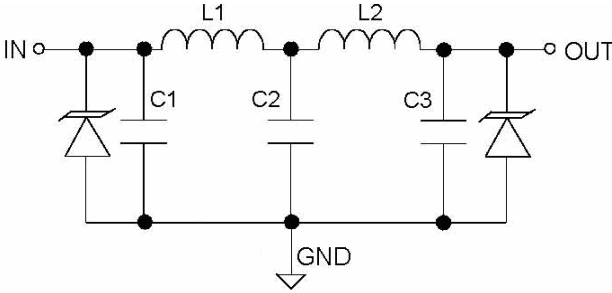
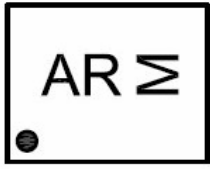
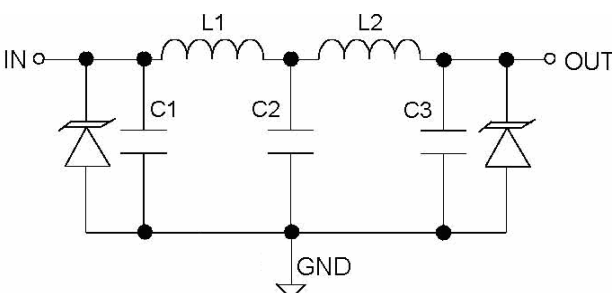
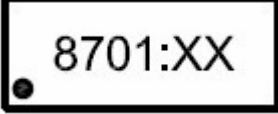
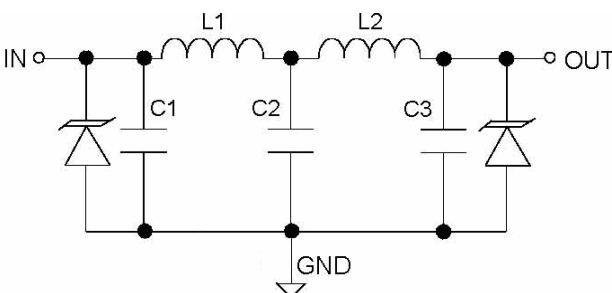
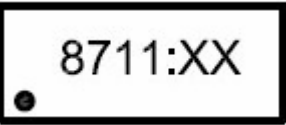
|   |   |
|---|---|
|  <p style="text-align: center;"><b>Device Schematic (4X)</b></p>   |  <p style="text-align: center;"> <b>M: Month Code</b><br/> <b>UM4701</b><br/> <b>DFN8 2.0×2.0</b> </p>   |
|  <p style="text-align: center;"><b>Device Schematic (4X)</b></p>  |  <p style="text-align: center;"> <b>M: Month Code</b><br/> <b>UM4711</b><br/> <b>DFN8 1.7×1.3</b> </p>   |
|  <p style="text-align: center;"><b>Device Schematic (8X)</b></p> |  <p style="text-align: center;"> <b>XX: Week Code</b><br/> <b>UM8701</b><br/> <b>DFN16 4.0×1.6</b> </p> |
|  <p style="text-align: center;"><b>Device Schematic (8X)</b></p> |  <p style="text-align: center;"> <b>XX: Week Code</b><br/> <b>UM8711</b><br/> <b>DFN16 3.3×1.3</b> </p> |

## Absolute Maximum Ratings

| PARAMETER                      | SYMBOL    | VALUE      | UNIT |
|--------------------------------|-----------|------------|------|
| ESD per IEC 61000-4-2(Air)     | $V_{ESD}$ | +/- 20     | kV   |
| ESD per IEC 61000-4-2(Contact) |           | +/- 15     |      |
| Junction Temperature           | $T_J$     | 125        | °C   |
| Operating Temperature Range    | $T_{OP}$  | -40 to 85  | °C   |
| Storage Temperature Range      | $T_{STG}$ | -55 to 150 | °C   |

## Electrical Characteristics

( $T_J=25\text{ }^\circ\text{C}$  unless otherwise noted)

| PARAMETER                              | SYMBOL      | CONDITIONS   | MIN | TYP | MAX | UNIT          |
|--|-------------|--|-----|-----|-----|---------------|
| TVS Reverse Stand-Off Voltage          | $V_{RWM}$   |  |     |     | 5   | V             |
| TVS Reverse Breakdown Voltage          | $V_{BR}$    | $I_t = 1\text{mA}$   | 6   | 8   | 10  | V             |
| TVS Reverse Leakage Current            | $I_R$       | $V_{RWM} = 3.3\text{V}$  |     |     | 0.1 | $\mu\text{A}$ |
| DC Resistance                          | $R_{cc}$    |  |     | 18  |     | $\Omega$      |
| Roll-off frequency at -6dB Attenuation | $f_R$       | $Z_{source} = Z_{load} = 50\Omega$                                 |     | 300 |     | MHZ           |
| Filter Cut-Off Frequency               | $f_c$       | $Z_{source} = Z_{load} = 50\Omega$                                 |     | 150 |     | MHZ           |
| Inductance                             | $L$         |  |     | 19  |     | nH            |
| Total series Inductance                | $L_1+L_2$   | Each Line  |     | 38  |     | nH            |
| Capacitance                            | $C_d$       | $V_R = 2.5\text{V}, f = 1\text{MHZ}$                               |     | 12  | 15  | pF            |
| Total Capacitance                      | $C_{total}$ | Input to Gnd,<br>Each Line<br>$V_R = 2.5\text{V}, f = 1\text{MHZ}$ |     | 36  | 45  | pF            |

## Typical Operating Characteristics

### Typical Insertion Loss

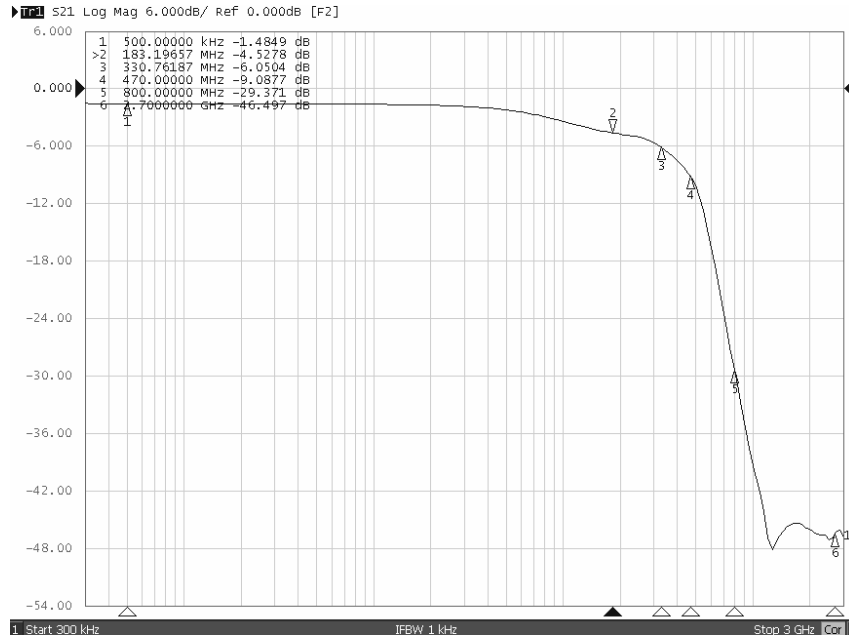

### Analog Crosstalk



## Applications Information

### Insertion Loss

Insertion Loss (IL) is used to describe the transmission coefficient between two points in a circuit often described in terms of dB. When examining S parameters, S21 is often described as insertion loss. Insertion Loss and S21 will be used interchangeably from here on out. The insertion loss of a circuit with VOUT and VIN would be expressed as

$$IL = S_{21}(\text{dB}) = 20\log(V_{\text{OUT}}/V_{\text{IN}})$$

The setup for measuring insertion loss in a 50 Ω system is shown in the figure below. It will be analyzed in a 50Ω environment, so the source impedance and load impedance is 50 Ω. The transfer functions then can be analyzed in terms of insertion loss (S21).

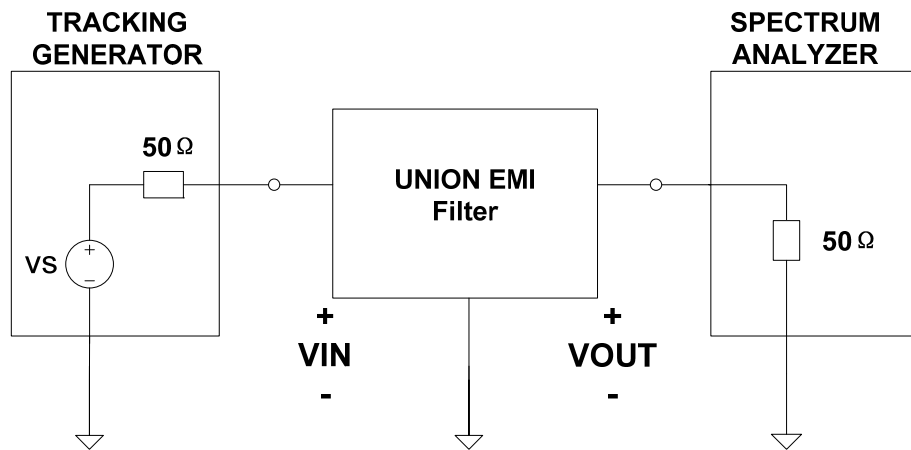

**Test Conditions:** Source Impedance = 50Ω  
 Load Impedance = 50Ω  
 Input Power = 0dBm

### Cut Off Frequency

Cut off Frequency is the frequency at which the signal strength is 3.0 dB less than it is Pass Band. 3.0 dB of attenuation equates to half the original signal power. The Pass Band is the range of frequencies that are allowed to “pass” through a filter with minimal attenuation. For our purposes it starts from DC and ends at the cut off frequency.

### Device Connection

The UM4701/UM4711/UM8701/UM8711 is comprised of identical circuits consisting of a low pass filter for EMI suppression and dual TVS diodes for ESD protection. The device is in an 8-pin DFN and 16-pin DFN package. Electrical connection is made to all the pins located at the bottom of the device. A center tab serves as the ground connection. The device has a flow through design for easy layout. All path lengths should be kept as short as possible to minimize the effects of parasitic inductance in the board traces.

## Ground Connection Recommendation

Parasitic inductance (L) present in the board layout will affect the filtering performance of the device. As frequency (f) increases, the effect of the inductance becomes more dominant. This effect is given by Equation 1.

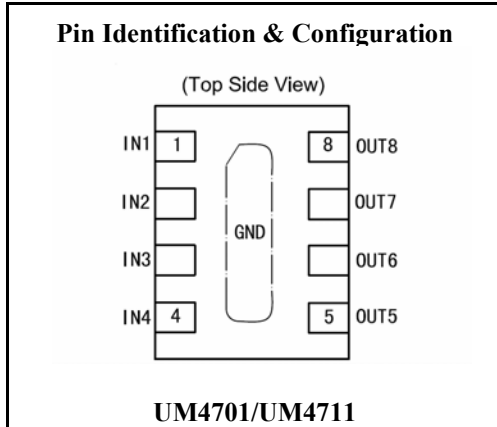

| Pin        | Identification |
|------------|----------------|
| 1 - 4      | Input Lines    |
| 5 - 8      | Output Lines   |
| Center Tab | Ground         |

**Equation 1: The Impedance of an Inductor at Frequency XLF**

$$X_{LF}(L, f) = 2 \times \pi \times f \times L$$

Where:  
 L= Inductance (H)  
 f = Frequency (Hz)

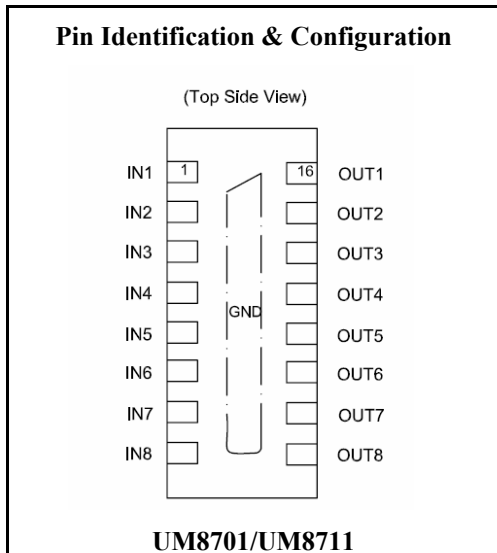

| Pin        | Identification |
|------------|----------------|
| 1 - 8      | Input Lines    |
| 9 - 16     | Output Lines   |
| Center Tab | Ground         |

**Equation 1: The Impedance of an Inductor at Frequency XLF**

$$X_{LF}(L, f) = 2 \times \pi \times f \times L$$

Where:  
 L= parasitic inductance in the PCB (H)  
 f = Frequency (Hz)

## Package Information

### UM4701: DFN8 2.0×2.0

#### Outline Drawing

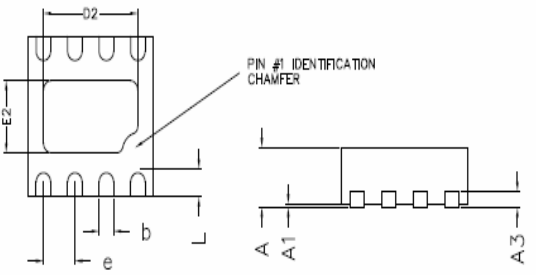

| DIMENSIONS |             |       |      |
|------------|-------------|-------|------|
| Symbol     | MILLIMETERS |       |      |
|            | Min         | Typ   | Max  |
| D          | 1.95        | 2.00  | 2.05 |
| E          | 1.95        | 2.00  | 2.05 |
| D2         | 1.35        | 1.50  | 1.65 |
| A          | 0.57        | 0.69  | 0.80 |
| A1         | 0           | 0.02  | 0.05 |
| A3         | -           | 0.152 | 0.20 |
| b          | 0.18        | 0.25  | 0.30 |
| E2         | 0.75        | 0.90  | 1.00 |
| L          | 0.20        | 0.30  | 0.40 |
| e          | -           | 0.50  | -    |

#### Land Pattern

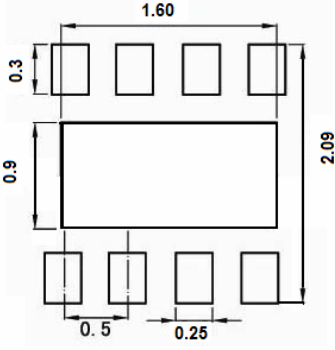

NOTES:

- Compound dimension: 2.0×2.0;
- Unit: mm;
- General tolerance ±0.05mm unless otherwise specified;
- The layout is just for reference.

#### Tape and Reel Orientation

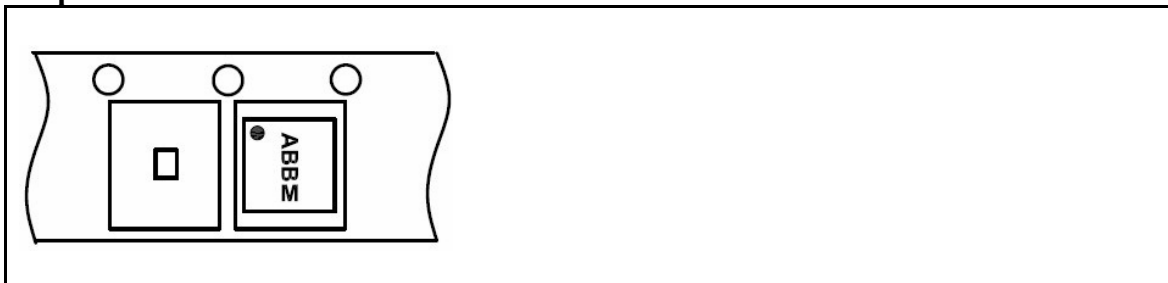





## UM8701: DFN16 4.0×1.6

### Outline Drawing

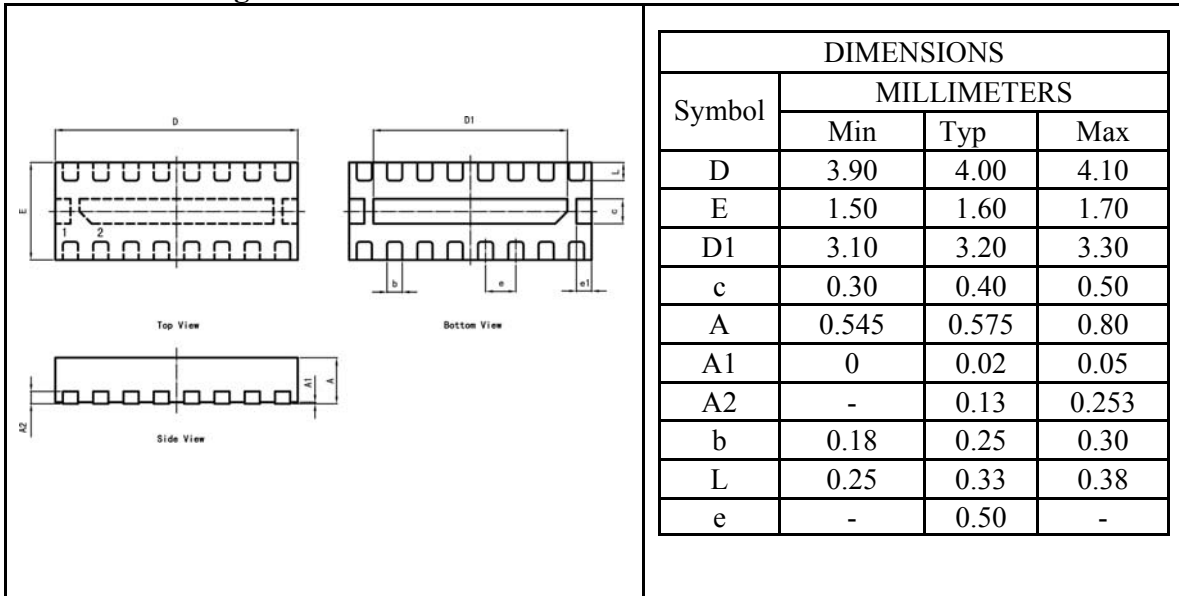

### Land Pattern

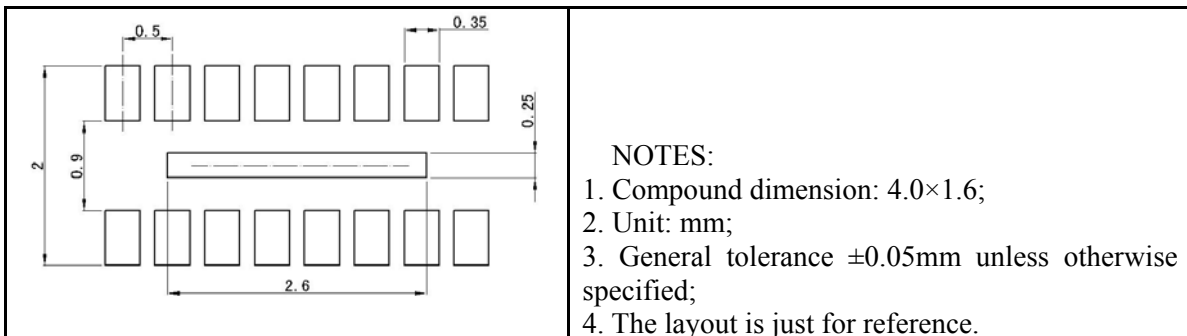

### Tape and Reel Orientation

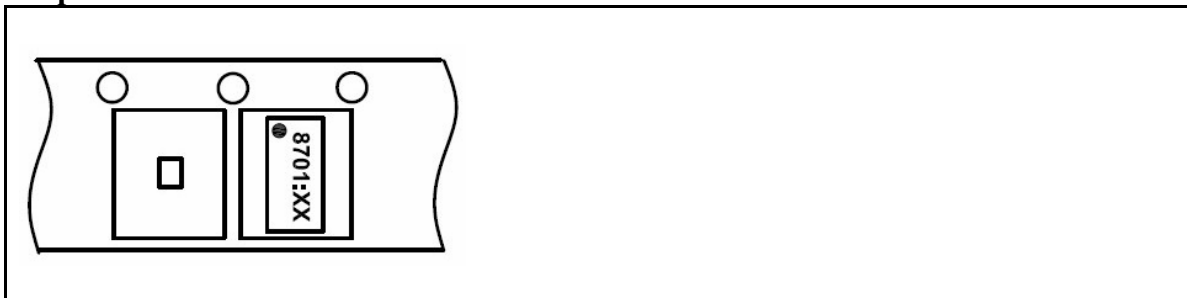

## UM8711: DFN16 3.3×1.3

### Outline Drawing

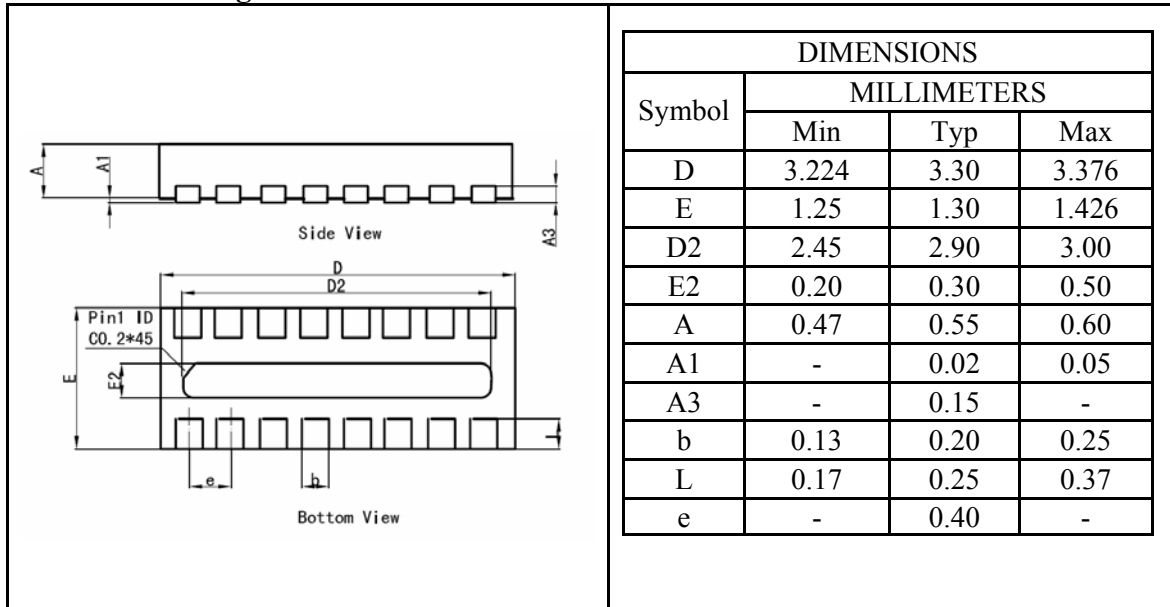

### Land Pattern

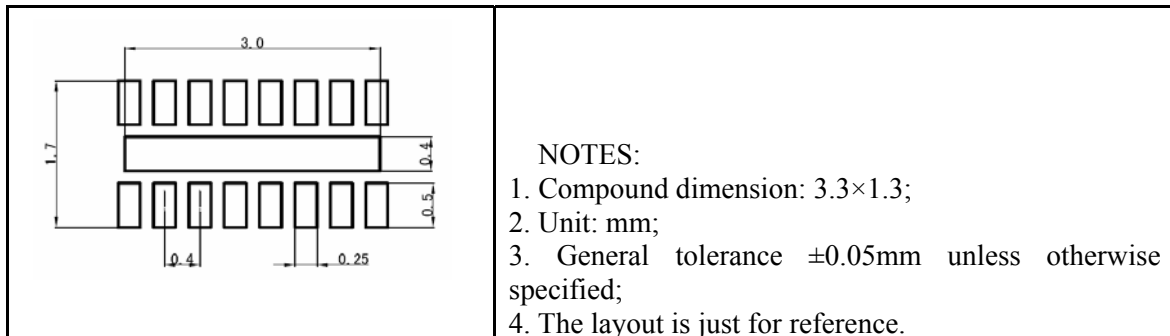

### Tape and Reel Orientation

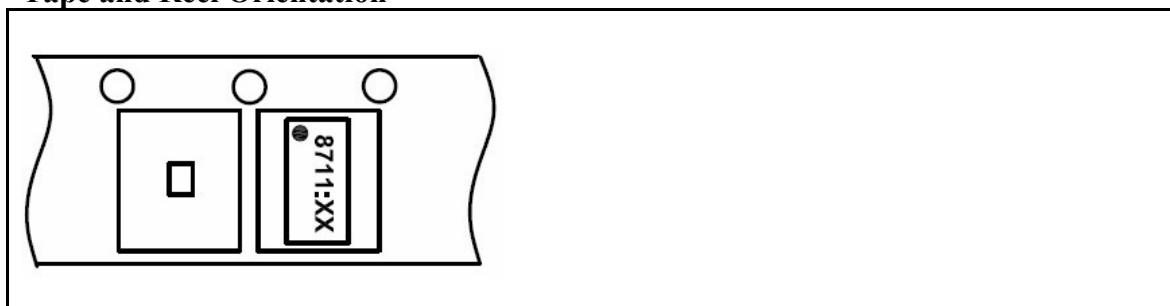

## IMPORTANT NOTICE

The information in this document has been carefully reviewed and is believed to be accurate. Nonetheless, this document is subject to change without notice. Union assumes no responsibility for any inaccuracies that may be contained in this document, and makes no commitment to update or to keep current the contained information, or to notify a person or organization of any update. Union reserves the right to make changes, at any time, in order to improve reliability, function or design and to attempt to supply the best product possible.



Union Semiconductor, Inc

Add: 2F, No. 3, Lane 647 Songtao Road, Shanghai 201203

Tel: 021-51093966

Fax: 021-51026018

Website: [www.union-ic.com](http://www.union-ic.com)