

## CDBW46-G

Reverse Voltage: 100 Volts

Forward Current: 150 mA

RoHS Device

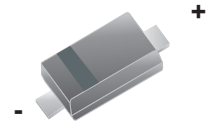

### Features

- Design for mounting on small surface.
- High breakdown voltage.
- Low trun-on voltage.
- Guard ring construction for transient protection.

### Mechanical data

- Case: SOD-123, Molded Plastic
- Terminals: Solderable per MIL-STD-202, Method 208
- Approx. Weight: 0.04 gram

### Circuit diagram

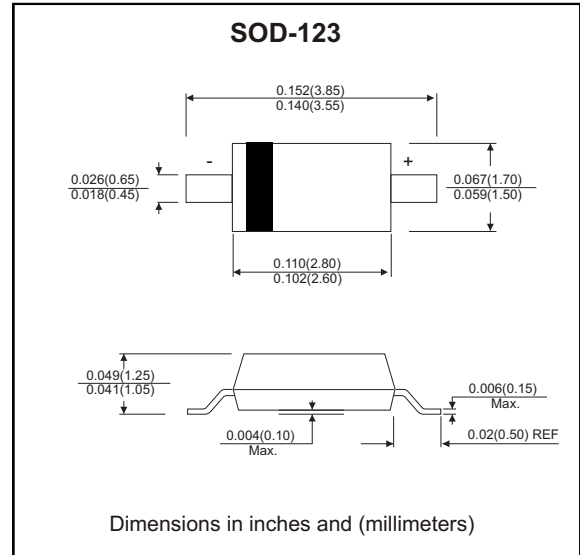

### Maximum Ratings (at Ta=25°C unless otherwise noted)

Parameter	Conditions	Symbol	Limits	Unit
Peak repetitive peak reverse voltage		V <sub>RRM</sub>	100	V
Working peak reverse voltage		V <sub>RWM</sub>		
DC blocking voltage		V <sub>R</sub>		
Forward continuous current		I <sub>F</sub>	150	mA
Repetitive Peak Forward current (Note 1)	@tp<1.0s, Duty Cycle<50%	I <sub>FRM</sub>	350	mA
Forward surge Forward current (Note 1)	@tp<10ms	I <sub>FSM</sub>	750	mA
Power dissipation		P <sub>D</sub>	200	mW
Thermal Resistance Junction to ambient air		R <sub>θJA</sub>	625	°C/W
Junction temperature		T <sub>J</sub>	-55 to +150	°C
Storage temperature		T <sub>STG</sub>	-55 to +150	°C

### Electrical Characteristics (at Ta=25°C unless otherwise noted)

Parameter	Conditions	Symbol	Min	Typ	Max	Unit
Reverse breakdown voltage (Note 2)	I <sub>R</sub> =100μA	V <sub>R</sub>	100			V
Forward voltage (Note 2)	I <sub>F1</sub> = 0.1 mA I <sub>F2</sub> = 10mA I <sub>F3</sub> = 250mA	V <sub>F</sub>			0.25 0.45 1.0	V
Reverse Voltage Leakage current	V <sub>R1</sub> = 1.5V V <sub>R2</sub> = 10V V <sub>R3</sub> = 50V V <sub>R4</sub> = 75V	I <sub>R</sub>			0.3 0.5 1 2	μA
Diode capacitance	V <sub>R</sub> =0V, f = 1 MHz V <sub>R</sub> =1V, f = 1 MHz	C <sub>T</sub>		20 12		pF

Notes: 1.Part mounted on FR-4 board with recommended pad layout.  
2.Short duration pulse test used to minimize self-heating effect.

## RATING AND CHARACTERISTIC CURVES (CDBW46-G)

Fig.1 - Typical Forward Characteristics

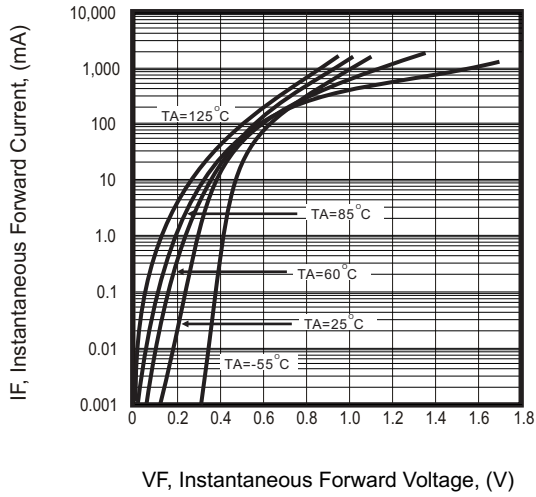

Fig.2 - Typical Reverse characteristics

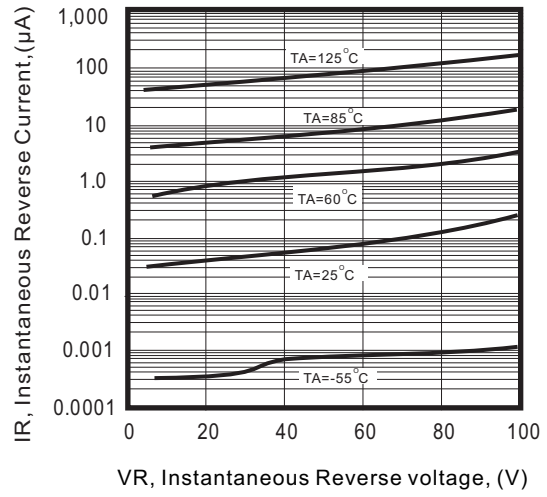

Fig.3 - Total Capacitance vs. Reverse Voltage

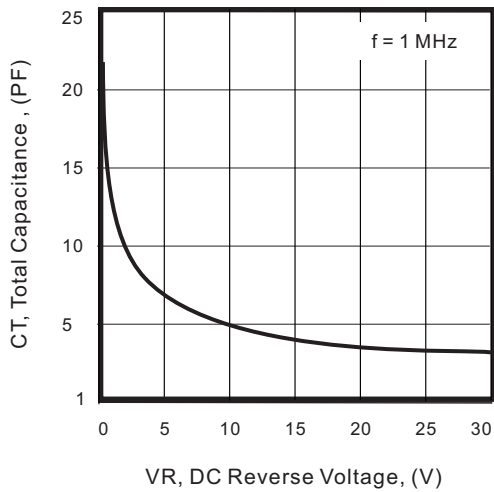
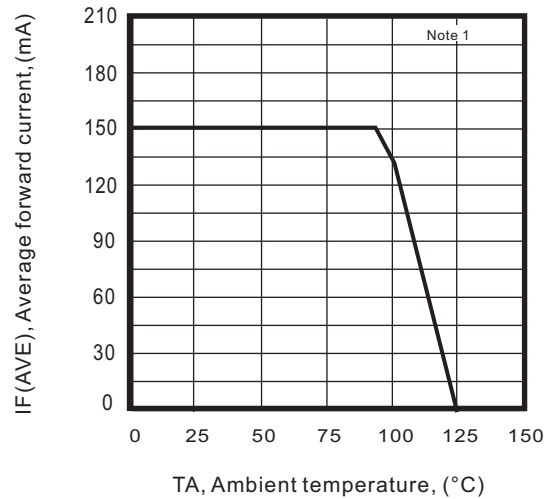
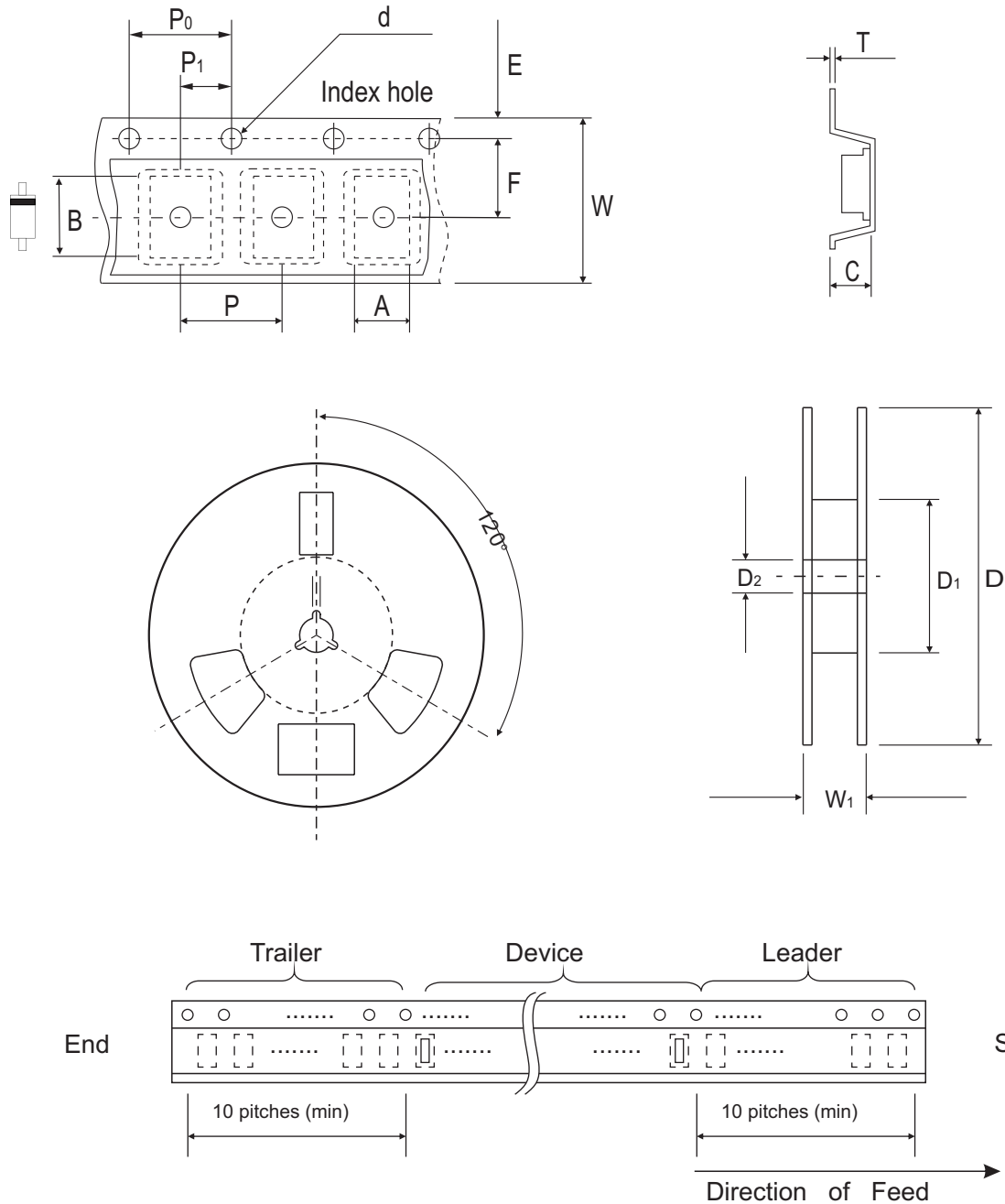

Fig.4 - Forward Current Derating



## Reel Taping Specification



SOD-123	SYMBOL	A	B	C	d	D	D1	D2
	(mm)	1.85 ± 0.10	3.94 ± 0.10	1.57 ± 0.10	1.55 ± 0.10	178 ± 1.00	54.40 ± 0.40	13.0 ± 0.20
	(inch)	0.073 ± 0.004	0.155 ± 0.004	0.062 ± 0.004	0.061 ± 0.004	7.008 ± 0.039	2.142 ± 0.016	0.512 ± 0.008

SOD-123	SYMBOL	E	F	P	P0	P1	W	W1
	(mm)	1.75 ± 0.10	3.50 ± 0.05	4.00 ± 0.10	4.00 ± 0.10	2.00 ± 0.10	8.00 + 0.30 / - 0.10	9.50 ± 1.00
	(inch)	0.069 ± 0.004	0.138 ± 0.002	0.158 ± 0.004	0.158 ± 0.004	0.079 ± 0.004	0.315 + 0.012 / - 0.004	0.374 ± 0.039

## Marking Code

Part Number	Marking Code
CDBW46-G	S9



xx= Product type marking code

## Suggested PAD Layout

SIZE	SOD-123	
	(mm)	(inch)
A	3.35	0.132
B	0.80	0.031
C	1.00	0.039
D	4.15	0.163
E	2.55	0.100

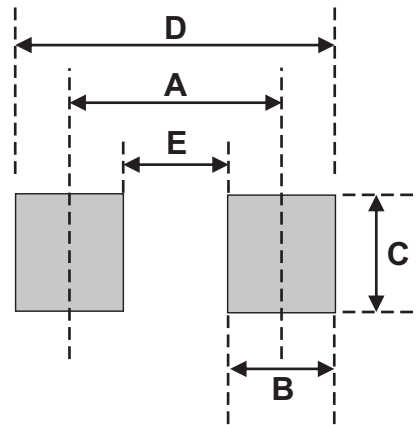

## Standard Packaging

Case Type	REEL PACK	
	REEL ( pcs )	Reel Size (inch)
SOD-123	3,000	7