

# AN7025K, AN7025S

## FM-IF, PLL-MPX, AM Tuner ICs

### Overview

The AN7025K and the AN7025S are the ICs designed for radio cassette recorder, incorporating AM tuner, FM-IF amplifier, FM detector and PLL multiplex demodulator.

### Features

- Single-chip IC for AM tuner, FM-IF & FM multiplexers
- Low power consumption,  $I_{CO} = 7.3\text{mA}$  (FM),  $4.5\text{mA}$  (AM)
- Wide operating supply voltage range :  $V_{CC} = 1.8\text{V} \sim 6.6\text{V}$
- Built-in stereo-indicator drive
- Phase-Locked-Loop MPX stereo demodulation

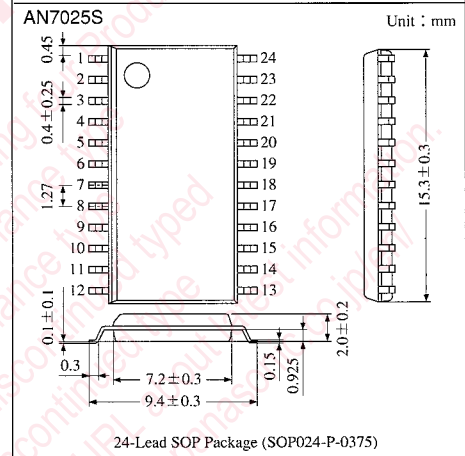
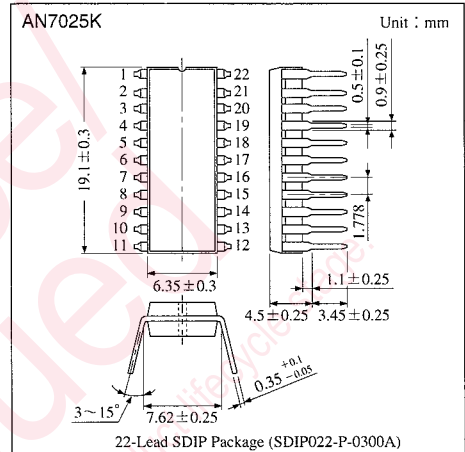

ICs for Tuner

### Block Diagrams

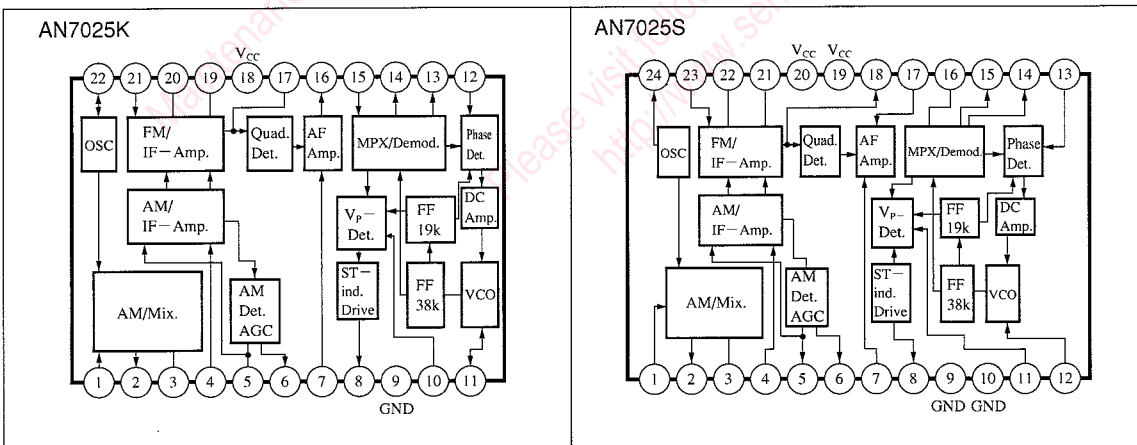

### Pin Descriptions

( ) shows the Pin No. of AN7025S.

Pin No.	Pin Name	Pin No.	Pin Name
1 (1)	AM Mixer Input	12 (13)	MPX Phase Detection
2 (2)	AM Mixer Output	13 (14)	L Ch. Output
3 (3)	AM Mixer By-pass	14 (15)	R Ch. Output
4 (4)	AM IF Input	15 (16)	MPX Input
5 (5)	AM AGC	16 (17)	IF-part AF Output
6 (6)	AM Detection Output	17 (18)	FM Detection Coil
7 (7)	AM AF Input	18 (19,20)	V <sub>CC</sub>
8 (8)	Stereo Indicator	19 (21)	IF By-pass 1
9 (9,10)	GND	20 (22)	IF By-pass 2
10 (11)	MPX Pilot Signal Detection	21 (23)	FM IF Input
11 (12)	VCO	22 (24)	AM Local Oscillation

### Absolute Maximum Ratings (T<sub>a</sub> = 25°C)

Parameter		Symbol	Rating	Unit
Supply Voltage		V <sub>CC</sub>	6.6	V
Supply Current		I <sub>CC</sub>	27	mA
Power Dissipation	AN7025K	P <sub>D</sub>	180	mW
	AN7025S		260	
Operating Ambient Temperature		T <sub>opr</sub>	-20 ~ +75	°C
Storage Temperature	AN7025K	T <sub>stg</sub>	-55 ~ +150	°C
	AN7025S		-55 ~ +125	

### Electrical Characteristics (V<sub>CC</sub> = 3V, T<sub>a</sub> = 25°C)

Parameter		Symbol	Condition	min.	typ.	max.	Unit
FM	Detection Output Voltage	V <sub>O(FM)</sub>	V <sub>in</sub> = 80dBμ, Monaural	45	56	70	mVrms
	Channel Balance	CB	V <sub>in</sub> = 80dBμ, Monaural	-1.2	0	1.2	dB
	Limiting Sensitivity	V <sub>L(FM)</sub>	Input which V <sub>O(FM)</sub> decrease by 3dB, Monaural	26	28.5	31	dBμ
	Stereo Separation	Sep.	V <sub>in</sub> = 80dBμ, Stereo	30	40	—	dB
	Total Harmonic Distortion	THD	V <sub>in</sub> = 80dBμ, Stereo	—	0.5	1.5	%
	Stereo Lamp ON Level	V <sub>P(on)</sub>	V <sub>in</sub> = 80dBμ, Modulation indication	—	5.5	7.5	%
	Stereo Lamp OFF Level	V <sub>P(off)</sub>	V <sub>in</sub> = 80dBμ, Modulation indication	1.1	3.1	—	%
AM	Detection Output Voltage	V <sub>O(AM)</sub>	V <sub>in</sub> = 60dBμ	50	65	90	mVrms
	Sensitivity	S <sub>(AM)</sub>	Input at V <sub>O(AM)</sub> = 20mA	12	16	23	dBμ

(Note) Unless otherwise specified.

FM : Monaural ; f<sub>in</sub> = 10.7MHz, 1kHz 30% modulationStereo ; f<sub>in</sub> = 10.7MHz, 1kHz 100% modulation (L+R = 90%, Pilot 10%)AM : f<sub>in</sub> = 1kHz, 400Hz 30% modulation

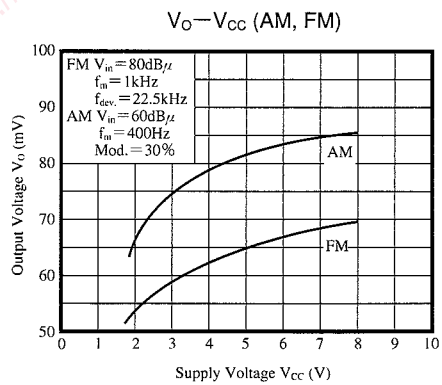
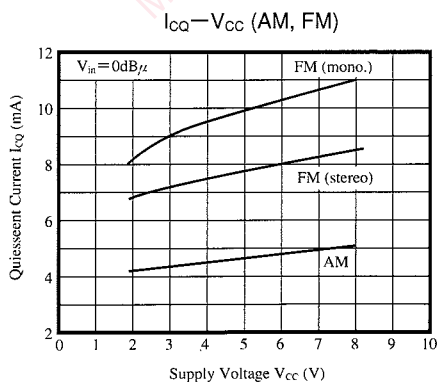
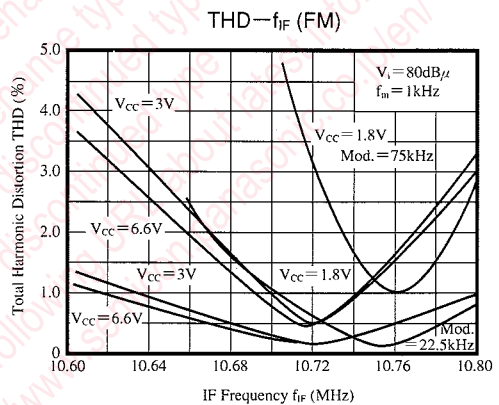
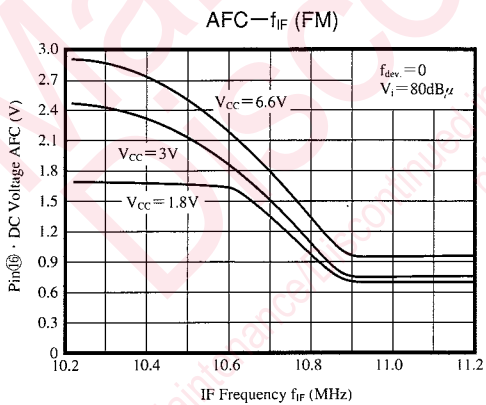
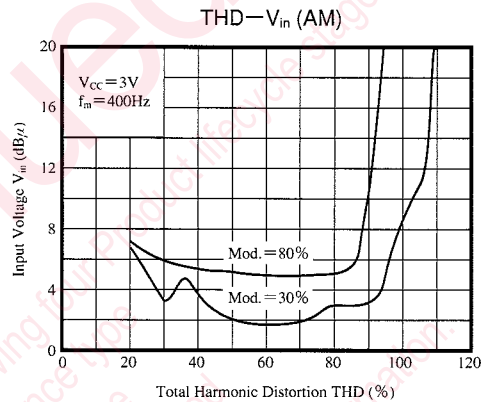
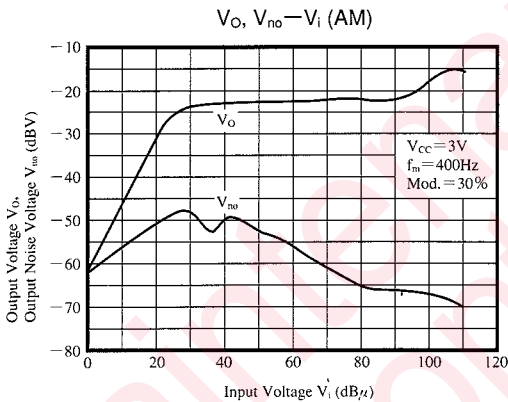
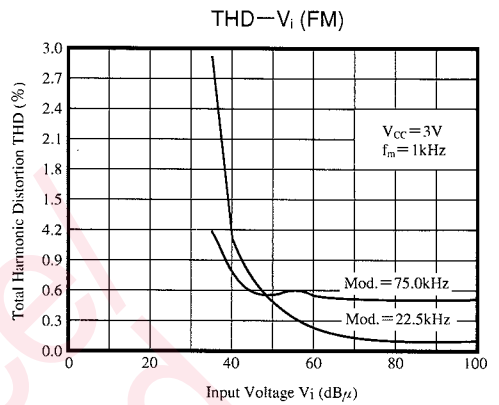
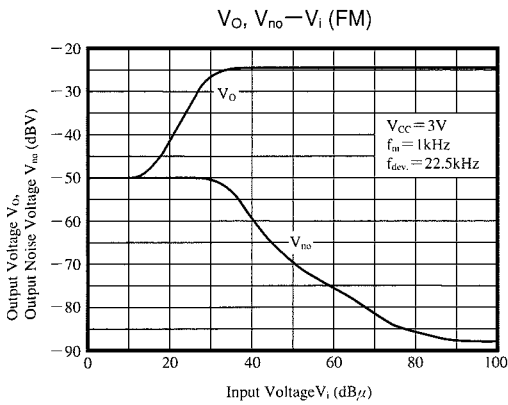

ICs for Tuner

$V_{im} - V_{CC}$  (FM)

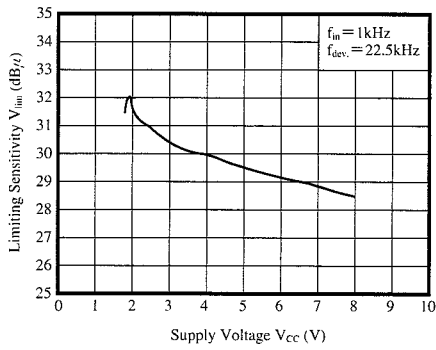

THD -  $V_{CC}$  (FM)

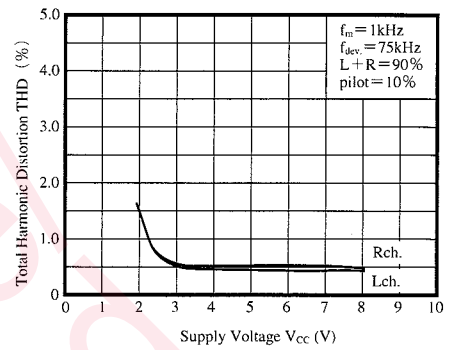

$S_{max} - V_{CC}$  (AM)

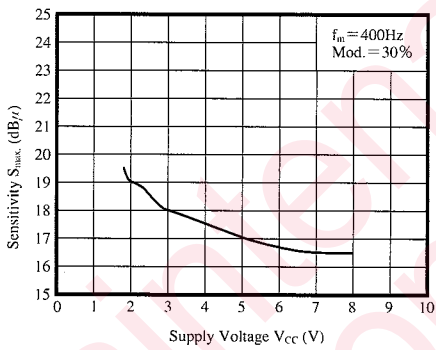

THD -  $V_{CC}$  (AM)

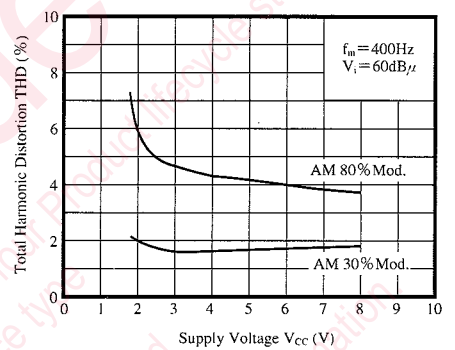

Sep. -  $V_{CC}$  (FM)

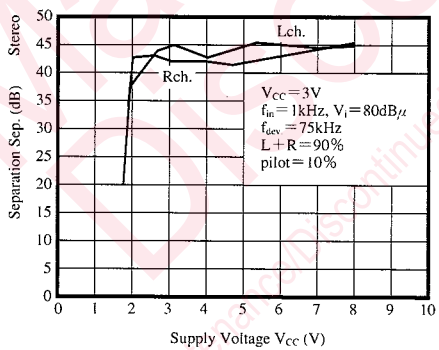

on/off -  $f_{pilot}$  (FM)

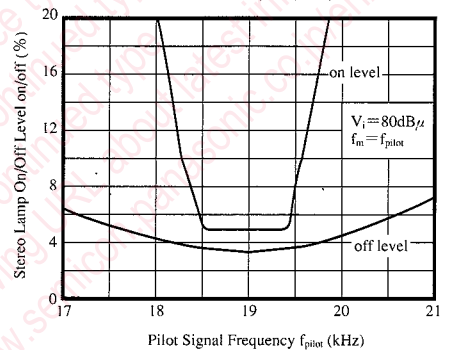

■ Application Circuit

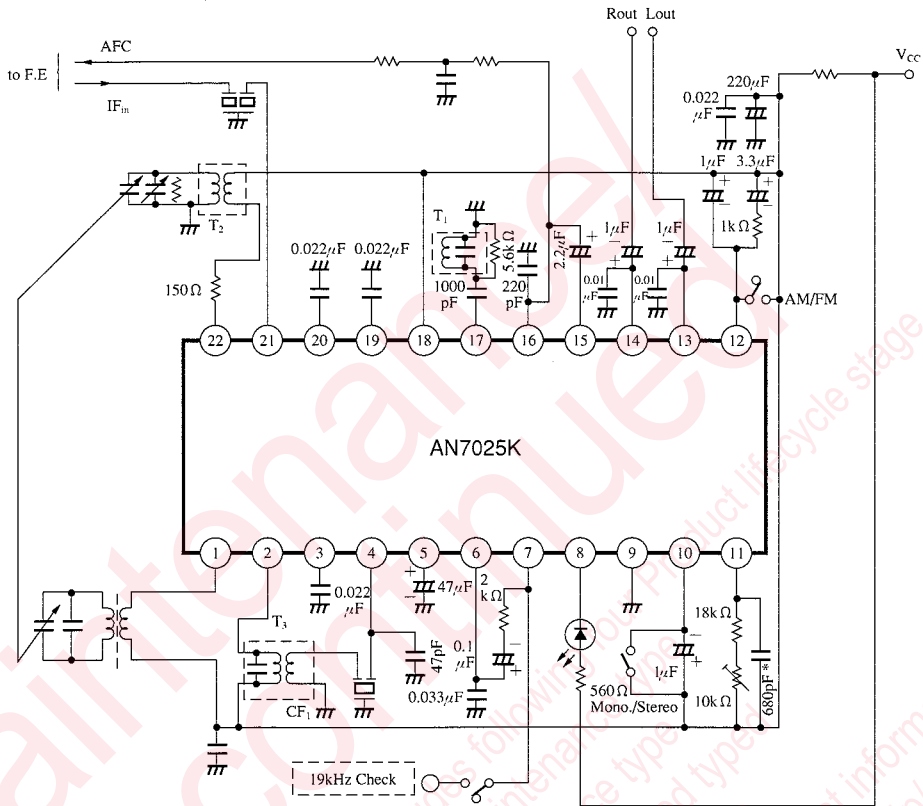

1. Styrol capacitor 680pF is used in order to improve VCO thermal characteristics.
2. AM AF output can be adjusted by the resistor between Pin⑥ and Pin⑦. Frequency characteristics of AM AF output can be changed (Figure 1) by  $C_1$ , R and input resistor  $R_{IN}$  (22kΩ) of Pin⑦.
3. Pin⑦ becomes 19kHz check pin at FM mode. At this time, resistor R between the Pin⑥—⑦ becomes 19kHz load and cannot be 0Ω.
4. Driving current of the Pin⑧ stereo indicator is about 5 mA (max.).
5. VCO frequency is adjusted by the half-fixed VR of Pin⑪ (Monitor is Pin⑦). Adjusting range is more than 10kΩ.
6. FM AFC is used by rectifying IF detection output of Pin⑯.
7. FM detection uses Quad. detection. When R is changed by the circuit construction in the figure 2, FM output level changes. However, caution should be taken as stereo lamp light-on level, light off level and THD changes.
8. Input impedance of the FM-IF input Pin⑫ is 470Ω as shown in figure 3.

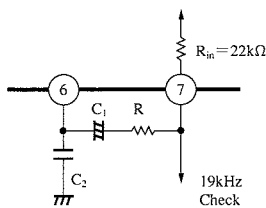

Fig.1

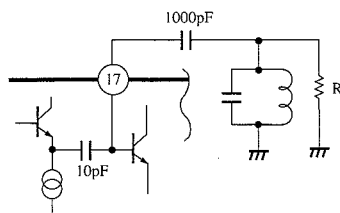

Fig.2

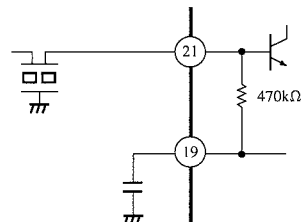

Fig.3

**Coil Specifications**

Symbol	Use, Freq.	Type No.	Maker	Connection Diagram	Number of Turns	Tuning Cap.	Unloaded Q
T <sub>1</sub>	FM Quad. Coil 10.7MHz	IFT-41K9	MITSUMI		①-②8T ②-③5T ④-⑥2T	100pF	90±20%
T <sub>2</sub>	AM MW Osc. Coil	L-5K7-H4	MITSUMI		①-③87T ④-⑥6T	—	100±20%
T <sub>3</sub>	AM Mix. Output 455kHz	IFT-21K7-1-14	MITSUMI		③-②4.3T ⑥-④1.4T ②-①10T	1500pF	130±30%

**Ceramic Filter Specification**

Symbol	Use	Type No.	Maker	Center Freq.	Band Width	Loss
CF <sub>1</sub>	AM IF	CFM2-455B	TOKO	455kHz	7kHz (-6dB)	2.6dB

**Printed Circuit Board Layout**

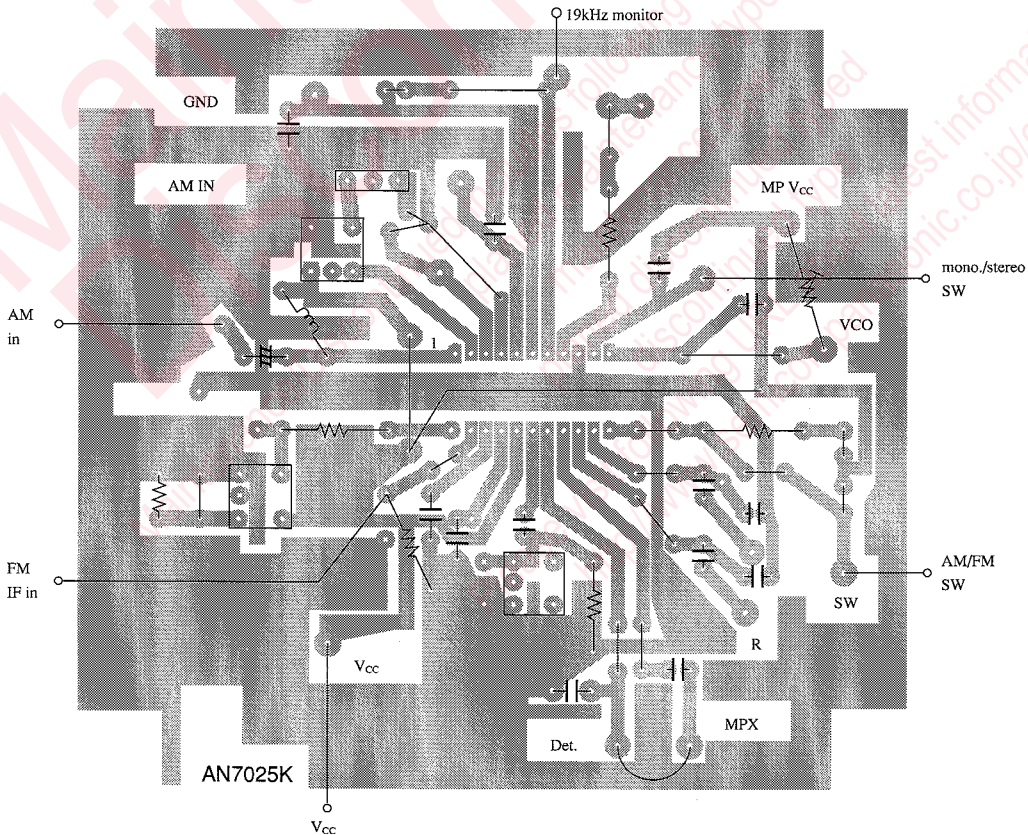

## Request for your special attention and precautions in using the technical information and semiconductors described in this book

- (1) If any of the products or technical information described in this book is to be exported or provided to non-residents, the laws and regulations of the exporting country, especially, those with regard to security export control, must be observed.
- (2) The technical information described in this book is intended only to show the main characteristics and application circuit examples of the products. No license is granted in and to any intellectual property right or other right owned by Panasonic Corporation or any other company. Therefore, no responsibility is assumed by our company as to the infringement upon any such right owned by any other company which may arise as a result of the use of technical information described in this book.
- (3) The products described in this book are intended to be used for standard applications or general electronic equipment (such as office equipment, communications equipment, measuring instruments and household appliances).  
Consult our sales staff in advance for information on the following applications:
  - Special applications (such as for airplanes, aerospace, automobiles, traffic control equipment, combustion equipment, life support systems and safety devices) in which exceptional quality and reliability are required, or if the failure or malfunction of the products may directly jeopardize life or harm the human body.
  - Any applications other than the standard applications intended.
- (4) The products and product specifications described in this book are subject to change without notice for modification and/or improvement. At the final stage of your design, purchasing, or use of the products, therefore, ask for the most up-to-date Product Standards in advance to make sure that the latest specifications satisfy your requirements.
- (5) When designing your equipment, comply with the range of absolute maximum rating and the guaranteed operating conditions (operating power supply voltage and operating environment etc.). Especially, please be careful not to exceed the range of absolute maximum rating on the transient state, such as power-on, power-off and mode-switching. Otherwise, we will not be liable for any defect which may arise later in your equipment.
  - Even when the products are used within the guaranteed values, take into the consideration of incidence of break down and failure mode, possible to occur to semiconductor products. Measures on the systems such as redundant design, arresting the spread of fire or preventing glitch are recommended in order to prevent physical injury, fire, social damages, for example, by using the products.
- (6) Comply with the instructions for use in order to prevent breakdown and characteristics change due to external factors (ESD, EOS, thermal stress and mechanical stress) at the time of handling, mounting or at customer's process. When using products for which damp-proof packing is required, satisfy the conditions, such as shelf life and the elapsed time since first opening the packages.
- (7) This book may be not reprinted or reproduced whether wholly or partially, without the prior written permission of our company.