

# TE-CORE6 | TE-CORE7

## ThermoHarvesting Power Module

Featuring ThermoGenerator-in-Package

- TGP-651
- TGP-751

Preliminary Datasheet

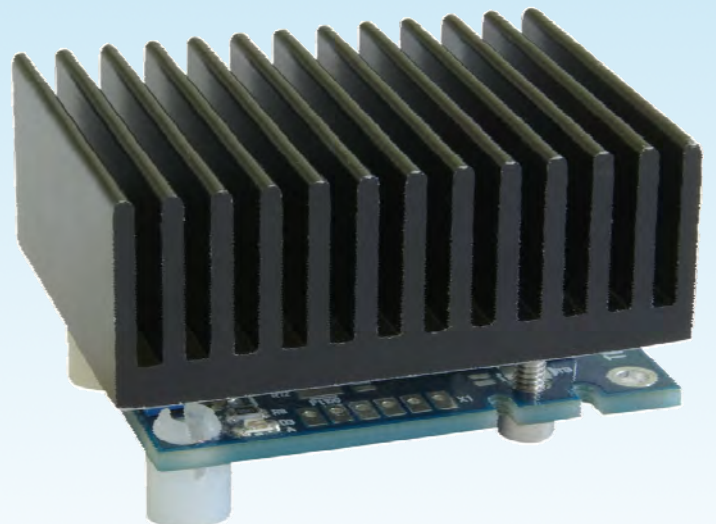
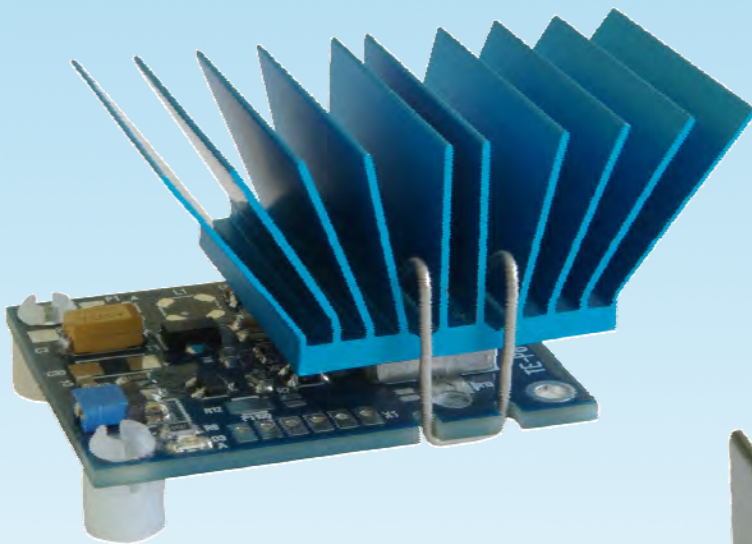

**Contents**

1.	Introduction .....	4
1.1	System Introduction .....	4
1.2	Features .....	4
1.3	Benefits .....	4
1.4	Applications .....	4
1.5	Energy Balance .....	5
1.5.1	Energy Storage .....	5
1.5.2	Hysteresis Voltage Control .....	5
1.6	Modular Thermo-Mechanical Design .....	6
1.7	Absolute Maximum Ratings .....	6
1.8	Mechanical Joints and max. force .....	6
1.9	Available Versions .....	6
2.	Introducing the TGP Package .....	7
2.1	TGP Properties .....	7
2.2	Output Power Performance in Application .....	7
2.3	TGP Electrical Performance without DC-DC Booster .....	8
2.4	Output Power and Battery Benchmark .....	9
3.	TE-CORE Components and Connectors .....	10
3.1	Output and Power Management .....	10
3.1.1	Storage charge Hysteresis configuration .....	10
3.1.2	Output Voltage Configuration .....	10
3.1.3	Thermogenerator Direct Access .....	11
3.2	Energy Storage .....	11
3.3	Power Supply and connector interfaces .....	11
3.4	Power Conditioning and Management .....	12
3.4.1	DC-Booster Start-up Requirements .....	12
3.5	DC-DC Booster Characteristics .....	12
4	Thermo Meets Electrics .....	14
4.1	Heatsink and Convection .....	14
4.2	Polarity and heat flux direction .....	14
4.3	Connection to hot source .....	14
5	Mechanical dimensions .....	15
5.1	Tolerances ISO 2768-mk .....	16
6	Product Information .....	16
6.1	Reliability Testing .....	16
6.2	Environmental compliance .....	16
6.3	Ordering information .....	16
7	Glossary .....	17
8	List of Document Changes .....	17
9	Disclaimer .....	19

**Congratulations !**

You have chosen a powerful and versatile thermal energy harvesting module. The TE-CORE serve you for desk and lab evaluation purposes or it may be used as an embedded green power supply for energy autonomous low-power electrical systems - typically with low duty cycles for control or maintenance.

We appreciate your choice of using Micropelt's thermoharvesting technology to explore the use of free ambient thermal power or waste heat instead of batteries. For a smooth start and sustainable success with your new device, please consider the following:

- Avoid intensive mechanical stress on the heat sink (shear or shock).
- Do not expose the TE-CORE Module to temperatures exceeding 105 °C [221°F].
- Protect the device against extensive humidity and direct water exposure
- Disassembly is not recommended ! The heatsink may be removed or replaced with appropriate care.

Please share your experience with us. We appreciate your feedback.

Beyond that you are welcome to leverage our engineering expertise . It will likely facilitate and accelerate your product design and time-to-market.

If you need further assistance, please contact us !

Free Power to You

The Micropelt Team

## 1. Introduction

### 1.1 System Introduction

The TE-CORE thermoharvesting module converts locally available waste heat thermoelectrically to indefinite free electric energy - as long as the heat flows through the thermogenerator (TEG). The integral power conversion and management circuit steps up the 'gradient-analog' output voltage of the TEG and outputs a fixed voltage (2.4 V by default). The harvested energy is being buffered in an extendable capacitor and controlled by a configurable hysteresis.

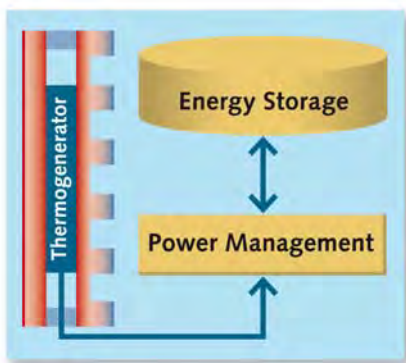

For the TE-CORE to serve as the exclusive power supply to an application it is mandatory to maintain a positive energy balance, i.e. the amount of energy harvested over a specific period must be equal or greater than the energy consumed over that same period (see 1.5).

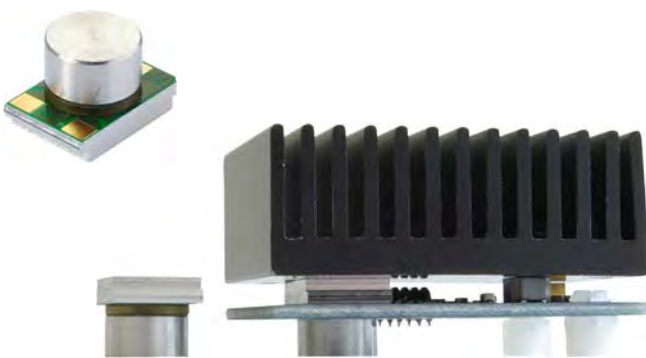

**TE-CORE Module with TGP Thermogenerator**

### 1.2 Features

- Operates from temperature differentials of  $< 10\text{ }^{\circ}\text{C}$  between a surface and ambient
- Operates on heat sources up to  $105\text{ }^{\circ}\text{C}$
- Also operates from cold sources
- High-efficiency low-cost DC-DC booster design, leveraging micro-thermogenerators with high output voltage and high electrical resistance
- Output voltage 2.4 V standard; configurable between 1.8 V and 4.5 V
- Extendable energy storage capacity
- Configurable buffer hysteresis
- Exchangeable heatsink
- Interface connector compatible with TI eZ430-RF2500T and similar wireless evaluation boards
- RoHS and WEEE compliant

### 1.3 Benefits

- Battery-free and cordless operation of electrical consumers
- Indefinite maintenance-free local energy
- Scalable harvesting capability: Supports Micropelt TGP-751 (TE-CORE7) and TGP-651 (TE-CORE6) Thermogenerator packages.
- Power supply for life-long operation of a low power device.

### 1.4 Applications

Consider thermoharvesting whenever both wiring and battery maintenance are hard to accept for reasons of cost, accessibility, manpower, logistics, hazard etc.

- Wireless sensors and sensor networks (WSN)
- Industrial process control & monitoring
- Condition monitoring
- Condition Based Maintenance (CBM)
- Thermal event logging and alerting
- Intelligent buildings and HVAC
- Automatic meter reading (AMR)
- Smart grid & metering
- Energy monitoring & control
- Remote sensing & tracking

1.5 Energy Balance

Energy harvesting in general, hence also thermoharvesting is suitable for low power, typically duty-cycling applications. The average energy consumed does not exceed the energy harvested; i.e. a positive or at least even energy balance is maintained.

1.5.1 Energy Storage

Any surplus energy which is not used by the application during its sleep phases is buffered in a storage capacitor (C3) which supplies surge currents during the load's active cycle. The size of the capacitor must be matched to the application's active cycle energy demand: the stored energy must be sufficient for at least one cycle. If the default capacitance is found insufficient the TE-CORE offers an interface for a user-configurable additional capacitor (see §3.2 Energy storage).

1.5.2 Hysteresis Voltage Control

The storage capacitor's charge level must always exceed the powered system's operating voltage to ensure stable supply. The actually available stored energy is defined by the total storage capacitance and the configured difference of the upper and lower thresholds of

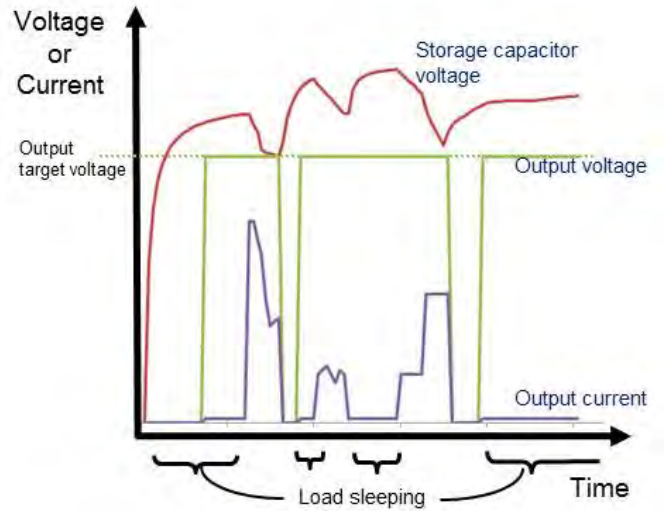

Power dropouts caused by excess surge current

the TE-CORE's hysteresis control (see p. 11) .  
 If the voltage of the energy buffer drops below the configured hysteresis minimum level the output of TE-CORE switches off to protect the continuous operation of the DC booster required for re-charging the buffer capacitor. Once the configured maximum capacitor voltage is reached, the output turns on again. This cycle is indicated by a LED: Each flash indicates a 'virtual active cycle' in replacement of a real load.

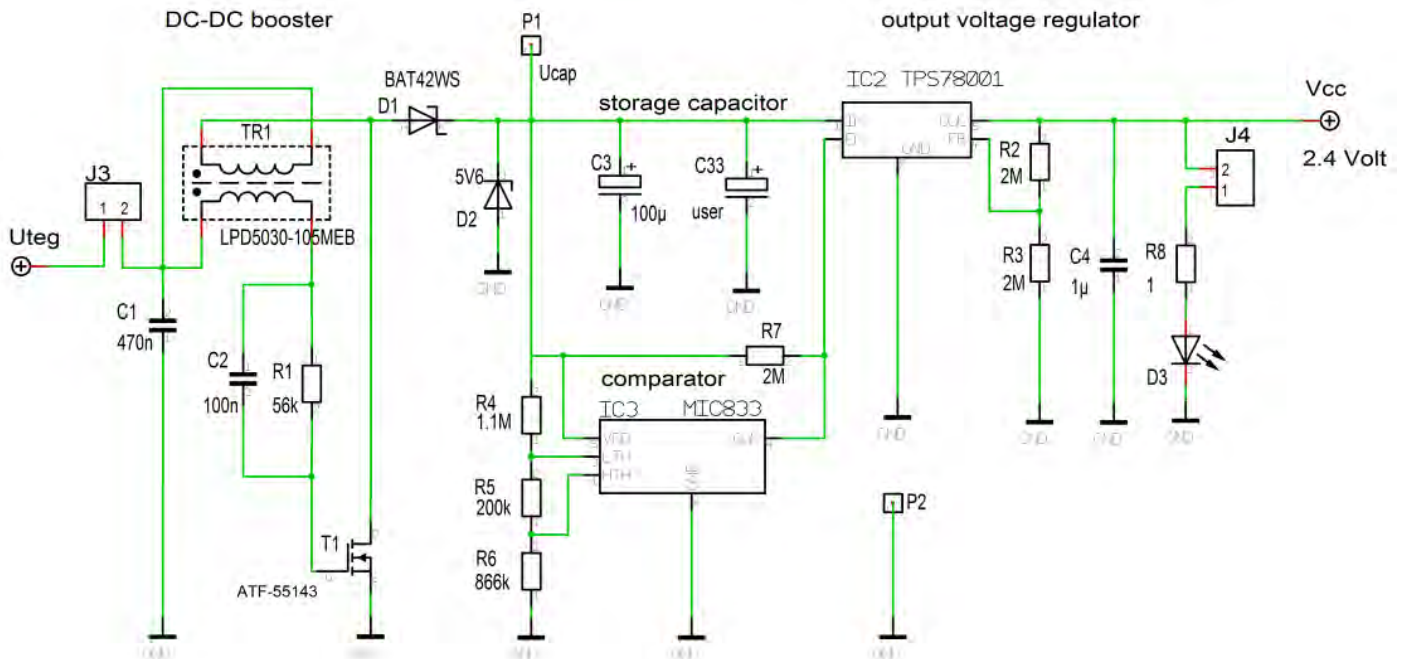

DC-DC Booster and power management of the TE-CORE Thermoharvesting Module

**1.6 Modular Thermo-Mechanical Design**

The Micropelt TE-CORE Thermoharvesting module operates from a heat (or cold) thermal energy source. The TGP’s aluminum top side, its thermal input, is supposed to be attached to the heat source. The thickness of the thermal input acts as a spacer to protect the PCB on one hand and to ensure a thermal separation between the hot and cold sides on the other, optimizing energy harvesting performance through suppression of thermal ‘cross talk’.

The thickness of the TGP’s thermal output was chosen to provide an initial heat spreading effect towards a heat sink and at the same time allowing for population of electronic components next to the TGP, even below the heatsink which usually extends well over the footprint of the TGP.

**1.7 Absolute Maximum Ratings**

Please ensure that during operation of the TE-CORE module the below maximum ratings are not exceeded:

	min	TYP	max
Hot side temperature	+ 10 °C	-	+ 100 °C
Ambient temp	0 °C		+ 85 °C
Storage temp	- 20 °C		+ 120 °C
ESD sensitivity	-	-	9000 V

**1.8 Mechanical and Thermal Interfaces**

The PCB and the heatsink are connected by two fastening screws, which fixes the TGP at the same time. Clamping force is max. 25 cNm, because of PCB. (see TE-CORE exploded view)

Between TGP and the heatsink a Graphite foil ensures a good thermal path. It is used eGraph type Hitherm 2505 with 127µm as thermal interface material.

**1.9 Available Versions**

The TE-CORE Thermoharvesting Module is available in two variations, differentiated by two types of TGP:

- **TE-CORE7:** TGP-751 containing TEG MPG-D751
- **TE-CORE6:** TGP-651 containing TEG MPG-D651

**Select TE-CORE7 over TE-CORE6 for:**

- Operation at lower temperature gradients
- Higher output power with better heatsink; —> 2x power over the TE-CORE6 is possible.

	TE-CORE7	TE-CORE6
DC-DC startup at 25 °C ambient	32.5 °C 90.5 °F	34.0 °C 93.2 °F

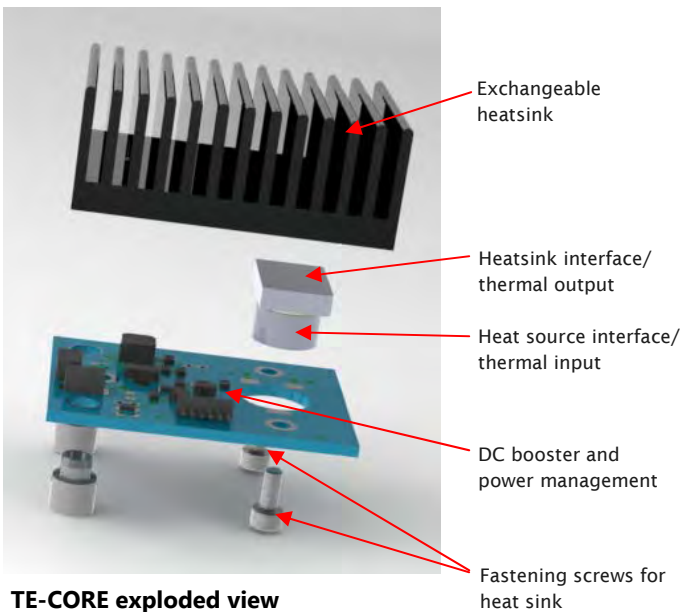

**TE-CORE exploded view**



**TGP package, ready for SMD assembly**

## 2 Introducing the TGP Package

Micropelt thermogenerators offer a unique power density, but mechanically they are quite sensitive. We have developed the TGP as a standard package which accommodates a range of TEG configurations. The TGP package protects the TEG, facilitates system integration and assembly. Its robustness simplifies thermal coupling and maximizes power output.

### 2.1 TGP Properties



Properties of TGPs	TGP-751	TGP-651
TEG inside	MPG-D751	MPG-D651
Electrical resistance $R_i$	240 - 350 $\Omega$	150 - 230 $\Omega$
Thermal resistance $R_{th}$	18 K/W	28 K/W
Thermovoltage $S$	110 mV/K	60 mV/K
Footprint (l x w x h)	15 x 10 x 9.3 mm	

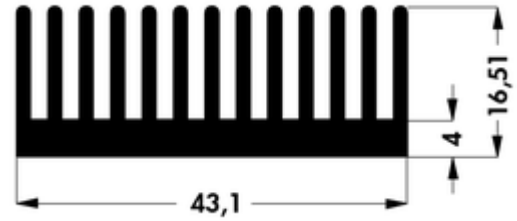

Dimensions Sk422 heat sink

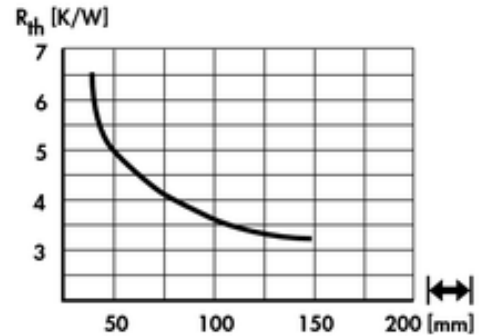

Performance diagram of Sk422 heat sink

Supplier [www.fischerelektronik.de](http://www.fischerelektronik.de)

For direct link to heatsink page use link below

<http://tinyurl.com/cw9aun6>

### 2.2 Output Power Performance in Application

The matched output power depends on the characteristics of the thermal path from heat source to ambient (cold side). The heatsink type, dimensions and position are of influence.

The TGP measurements are made with TE-CORE7 using different heat sinks from Fischer Elektronik, type Sk422 with a length of 33 mm, 50 mm and 90 mm.

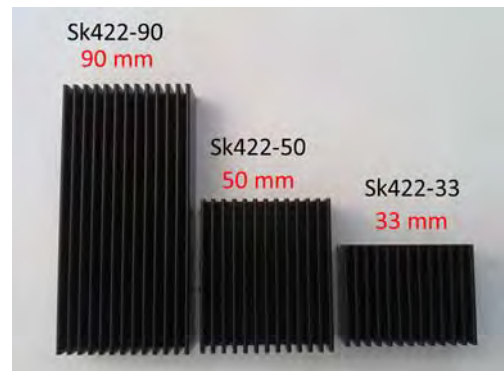

Different heat sink types of Sk422



TE-CORE with transparent heat sink



TE-CORE with heat sink Sk422-33





## 2.4 Output Power and Battery Benchmark

The table below provides select output characteristics of the TGP-751, integrated in a TE-CORE7 module in standard configuration and under standard lab conditions. The DC-DC booster is not used.

For an easy matching with known battery consumption figures an annual 'gross' harvesting result is provided, assuming constant thermal conditions.

**TGP Output power and Battery-Equivalent (at 25°C ambient)**

	T <sub>hot</sub> [°C]	U <sub>oc</sub> [Volt]	Power [mW]	Annually [mAh]	Batteries [AA]
TE-CORE7*	40	0.56	0.36	2.102	1-2
	50	0.96	1.1	6.424	3-4
	60	1.4	2.2	12.848	> 6

\*Heatsink: Fischer Elektronik, Sk422-33-SA

The output voltage of the TGP-751 at a given external (gross) temperature differential is higher than that of the TGP-651. Hence the DC-DC booster starts at lower delta-T conditions. Better starting conditions may be achieved by using a more efficient heat sink, as mentioned in next table (at ambient of 25 °C / 77 °F):

	Small HS (Sk422 33)	Midsized HS (Sk422 50)	Larger HS (Sk422 90)
<b>TE-CORE6</b>	34.0 °C [93.2 °F]	33.5 °C [92.3 °F]	32.5 °C [90.5 °F]
<b>TE-CORE7</b>	32.5 °C [90.5 °F]	32.0 °C [98.6 °F]	31.0 °C [87.8 °F]

The table below describes the increase of output power with different heat sink sizes.

	Small HS (Sk422 33mm)	Midsized HS (Sk422 50)	Larger HS (Sk422 90)
<b>TE-CORE6</b>	100%	125%	135%
<b>TE-CORE7</b>	100%	130%	185%

For TE-CORE7 a bigger heatsink generates a significant increase in output power, due to the lower thermal resistance of TPG-751. Whereas for TE-CORE6 the advantages of large heatsinks are limited.

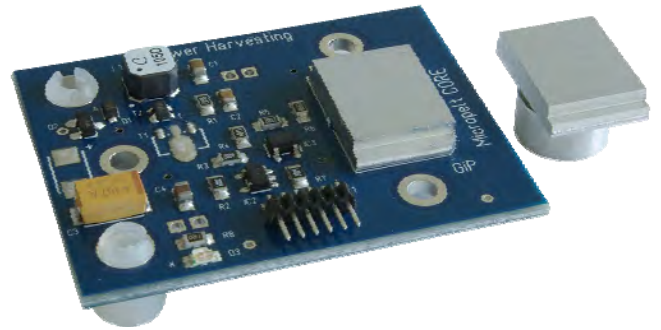

TE-CORE top side view (without heat sink)



TE-CORE bottom side view (without heat sink)

3. TE-CORE Components and Connectors

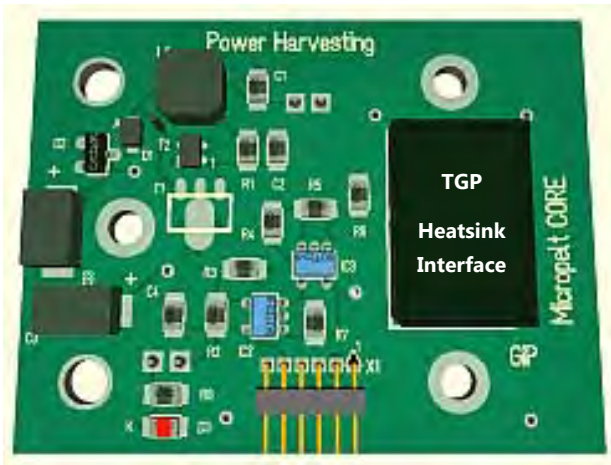

PCB top view

- TGP: TGP-751 or TGP-651
- X1: Connector for Texas Instrument evaluation board eZ430-RF2500T (PIN 2 - VCC; PIN 5 - GND)
- C3: Storage capacitor 100  $\mu$ F
- C33: Capacitor extension interface

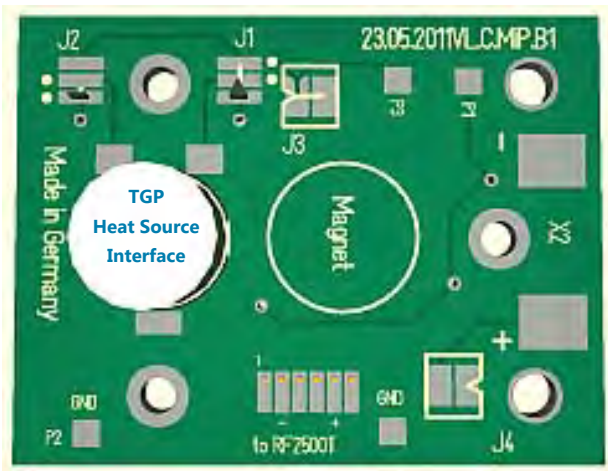

PCB bottom view

- J<sub>1</sub>, J<sub>2</sub>: Soldering pads output polarity selection
- J<sub>3</sub>: Soldering pad to disconnect TGP from DC-DC booster / power management
- X<sub>2</sub>: Regulated DC output;  $U_{out} = 2.4$  Volt by default
- C<sub>33</sub>: Capacitor extension interface (not populated)
- J<sub>4</sub>: Soldering pad to disconnect indicator LED D<sub>3</sub>
- P<sub>1</sub>: Test pad for storage capacitor voltage
- P<sub>2</sub>: GND
- P<sub>3</sub>: Raw TGP output (disconnect J<sub>3</sub> before use)
- Magnet - Mounting position for permanent magnet

3.1 Output and Power Management

The TGP output voltage is stepped-up to a maximum voltage of 5.5 V. The harvested energy is buffered in capacitor C<sub>3</sub>. A configurable hysteresis control ensures the buffer is full before the TE-CORE's output is activated, and turned off before the target output voltage is under run or even killing the step-up oscillation. The output voltage is controlled by a configurable comparator.

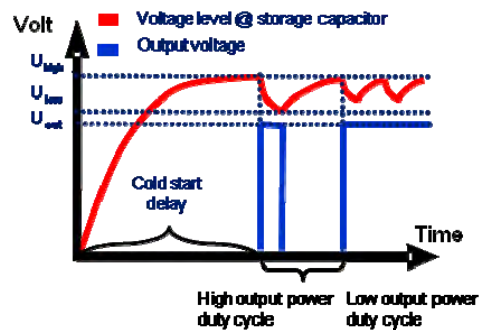

3.1.1 Storage Charge Hysteresis Configuration

The comparator (IC<sub>2</sub>, MICREL [MIC833](#)) turns the output ON once the voltage of capacitor C<sub>3</sub> reaches U<sub>high</sub> set by the resistors R<sub>4</sub>, R<sub>5</sub> and R<sub>6</sub> according to Equations 1 below. The output is turned OFF when the voltage of C<sub>3</sub> under runs U<sub>low</sub>, so the entire harvested energy is used to recharge the storage capacitor C<sub>3</sub>.

$$U_{low} = U_{ref} \cdot \left( \frac{R_4 + R_5 + R_6}{R_5 + R_6} \right) \tag{Eq. 1}$$

$$U_{high} = U_{ref} \cdot \left( \frac{R_4 + R_5 + R_6}{R_6} \right) \quad U_{ref} = 1.24 \text{ Volt} \tag{Eq. 2}$$

3.1.2 Output Voltage Configuration

The comparator (IC<sub>3</sub>, TI [TPS780 Series](#)) controls the configurable constant output voltage of the TE-CORE module (2.4 V by default) as long as the voltage from IC<sub>2</sub> is ON. The voltage level is set by the resistors R<sub>2</sub> and R<sub>3</sub> according to Equation 2 below.

$$U_{out} = U_{FB} \cdot \left( 1 + \frac{R_2}{R_3} \right) \quad U_{FB} = 1.216 \text{ Volt} \tag{Eq. 3}$$

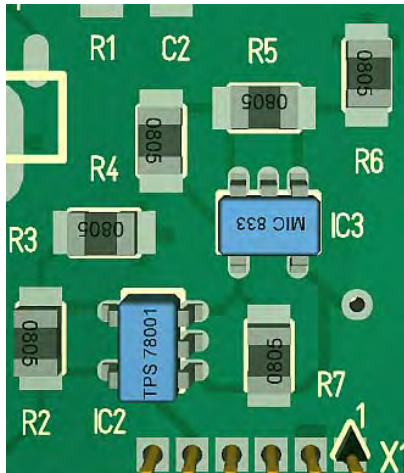

**Power Management Circuitry**

Above screenshot shows the voltage regulator IC<sub>2</sub> TPS78001, the hysteresis comparator MIC833 and the related resistors R<sub>2</sub> - R<sub>6</sub>.

To change the TE-CORE output voltage and/or hysteresis, please refer the table below. Use equations 1 and 2 on page 10 to calculate different settings.

Voltage regulator			Comparator hysteresis				
U <sub>out</sub> [V]	R <sub>3</sub> [MΩ]	R <sub>2</sub> [MΩ]	R <sub>4</sub> [kΩ]	R <sub>5</sub> [kΩ]	R <sub>6</sub> [kΩ]	U <sub>low</sub> [V]	U <sub>high</sub> [V]
1.8	2	0.953	470	200	680	1.9	2.46
2.0	2	1.3	550	150	680	2.1	2.5
2.4	2	2	860	160	680	2.5	3.1
2.7	1.5	1.8	1000	150	680	2.73	3.3
3.0	1	1.5	1500	150	845	3.1	3.66
3.3	1	1.8	2500	249	1200	3.37	4.1
4.5	1	2.7	2000	75	680	4.52	5

**3.1.3 Thermogenerator Direct Access**

Desolder contacts of J<sub>3</sub> to disconnect thermogenerator and power management. With open J<sub>3</sub> both open circuit voltage (U<sub>oc</sub>) and short circuit current (I<sub>sc</sub>) of the TEG can be measured at the circuit control points P<sub>3</sub> and P<sub>2</sub>. The measured values at any specific operating point allow for calculation of the maximum available power P<sub>max</sub> according to Equation 4 below:

$$P_{max} = U_{oc} \cdot \frac{I_{sc}}{4} \tag{Eq. 4}$$

**3.2 Energy storage**

Energy harvesting power supply implies a duty cycling application. The harvester usually does not provide enough power to run the application during its active mode. An energy buffer is needed.

Capacitance and maximum current characteristics of the storage capacitor in concert with the hysteresis settings (see 3.1.2) must comply with both surge current and pulse duration of the application's active cycle.

Important parameters of energy storage devices:

- Low leakage
- Low equivalent serial resistance (ESR) << 1 Ohm

**Note:** In case thin film batteries (TFB) are considered instead of capacitors, e.g. for their extremely low leakage, additional care must be taken to avoid damage of the TFB through overcharge or deep discharge.

**3.3 Power supply and connector interfaces**

An interface is available to connect the TE-CORE Power harvesting kit to existing ultra-low power electronics or wireless modules. Connector X<sub>1</sub> is positioned on the right side of the TE-CORE module (pitch 1.27 mm [0.05]). This connector is compatible to the TI eZ430-RF2500T wireless evaluation board.

**Connector X1:**

**Connection of TI module RF2500T**

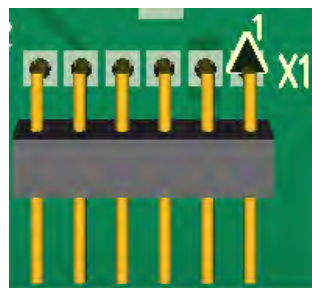

- Pin 1,3,4,6 are not connected
- Pin 2: VCC supply voltage (standard 2.4 V)
- Pin 5: GND

When connecting the TI ez430-RF2500T evaluation board to the Micropelt TE-CORE Power Harvesting System please note the following notifications.

- The TI radio communication link (TI demonstration software) requires a relative high amount of energy for its initial radio link set-up,
- Initial link set-up needs for 100ms approximately 20mA current and operating voltage = 2.4 Volt [energy consumption 4.8mJ]
- Change the value of capacitor C<sub>3</sub> and add C<sub>33</sub> 1500µF capacitor (2x 1500µF = 3000µF; for example: **Vishay** Model 592D158X06R3R2T20H).
- Set the comparator hysteresis to follow options: V<sub>cc</sub> turn "off" = 2.6 Volt; V<sub>cc</sub> turn "ON" = 3.9 Volt. Replace the resistor R<sub>4</sub> –R<sub>6</sub> to the next values: R<sub>4</sub> = 1.5 MΩ, R<sub>5</sub> = 470 kΩ, R<sub>6</sub> = 910 kΩ

**3.4 Power Conditioning and Management**

The TE-CORE’s DC-DC booster and power conditioning module provides a reference for a low-cost, high efficiency pure thermoharvesting power supply. It consequently uses carefully selected off-the-shelf components in a electronic circuit which best leverages the special electrical properties of our TEGs: high resistance and high thermovoltage. Configurable power management functions allow for flexible adaptation to a host of ultra-low-power applications.

**3.5 DC-DC Booster Characteristics**

DC-DC booster output voltage is set to 2.4 Volt. Measurement with FET Transistor at oscillator part ATF-55143 and storage capacitor C<sub>3</sub>= 100 µF:

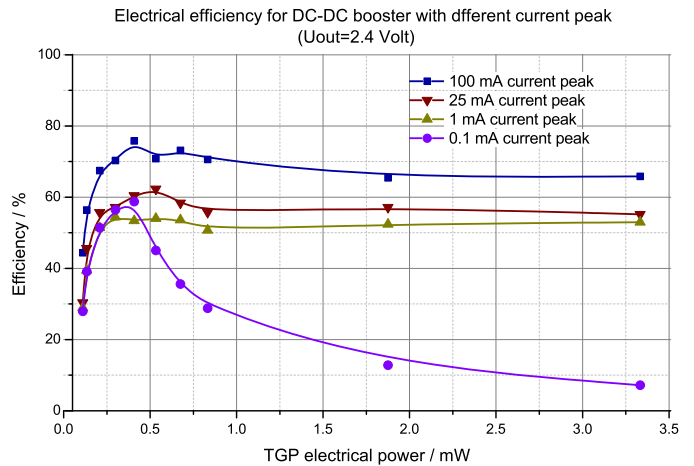

The DC-DC booster is optimized for start up with low temperature gradients.

In applications with small load currents, the efficiency looks reduced while the energy storage device is being changed and current being used by the load in parallel.

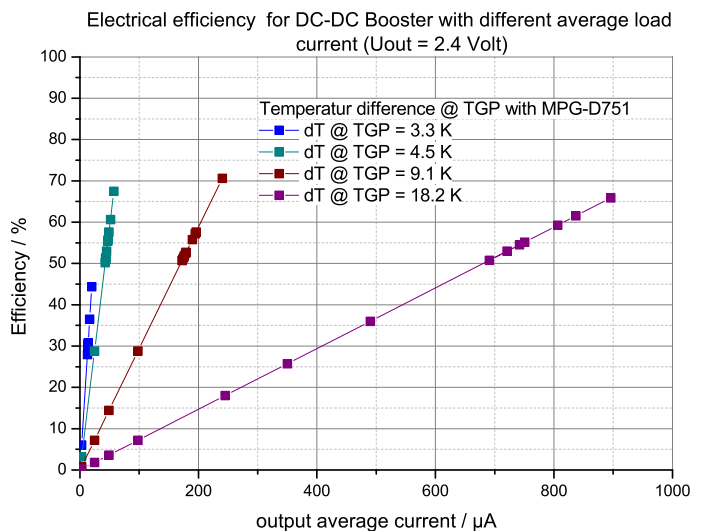

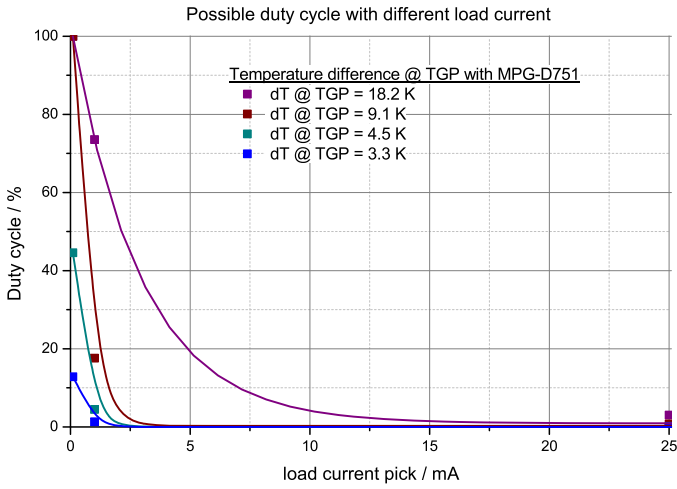

At high, continuous current requirements of the load of the TE-CORE power harvesting kit, a continuous operation is not possible.

Common energy harvesting equipment operate in a "duty-cycle" mode, where the load is mostly in standby mode and only active for a short period of time. The size of the energy storage device can be adapted by the footprint position of C<sub>33</sub>.

3.5.1 DC-DC Booster Efficiency

TE-CORE7 @ 25°C ambient			
Hot side temp	40 °C		
Output voltage	2.39 V	2.40 V	2.44 V
Output power	0.36 mW		
Current peak	1 mA	25 mA	150 mA
DC Boost efficiency	52 %	57 %	>80 %
Hot side temp	60 °C		
Output voltage	2.39 V	2.40 V	2.44 V
Output power	1.8 mW		
Current peak	1 mA	25 mA	150 mA
DC Boost efficiency	52 %	64 %	> 80 %

## 4 Thermo Meets Electrics

### 4.1 Heatsink and Convection

Both positioning and orientation of the TE-CORE are of major importance for the harvesting yield. The orientation of the heatsink and its fins relative to the heat source and the direction of natural or forced convection deserve special attention.

Please avoid placing the TE-CORE in horizontal orientation on top of a heat source. This will minimize the effective temperature differential. Prefer a mounting position on the side or underside of a heat source.



#### Heatsink orientation matters!

A forced air flow along the heatsink fins, e.g. from a motor fan or ventilator, usually maximizes power regardless of mounting position and natural convection.

### 4.2 Polarity and heat flux direction

Along with a change of the heat flux direction, the polarity of the TGP's output voltage inverts.

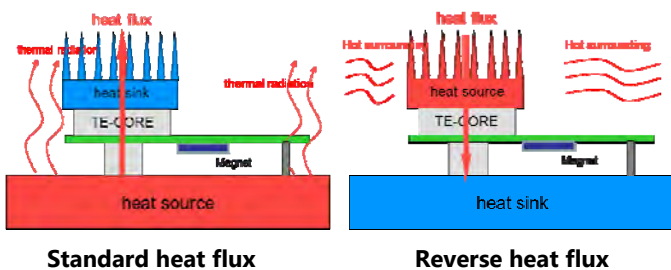

Standard setting is for the TGP **TOP side to be the hot side** and the heat sink is the cold side or room temperature of the thermal path.

Due to the uni-polar design of the TE-CORE, a manual polarity option is provided. Solder pads are available on the bottom side of the PCB ( $J_1$  and  $J_2$ ), by which the polarity can be determined.

This gets around the losses that a rectifier would introduce but requires an engineering action to change the direction of the heat flux.



**Solder pads  $J_1$  and  $J_2$**  connection for heat flux direction (standard delivered)



**Solders pad  $J_1$  and  $J_2$**  connection for reversed heat flux direction

### 4.3 Connection to hot source

The best method to connect the TE-CORE power harvesting kit to a hot source is by:

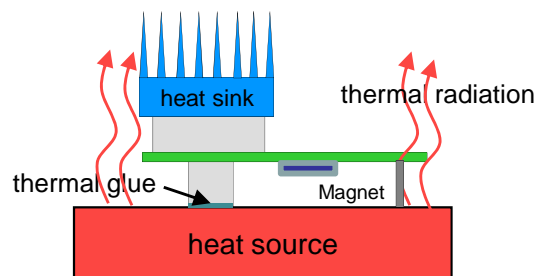

- **Magnetic surface** - in this case simply to use the magnet on the bottom side from TE-CORE Module
- **None magnetic surface** - use the enclosed self-adhesive magnetic disks to connect to the hot surface. Please remove the protector foil from the self-adhesive magnetic disks and connect to the warm surface. In the next step set the middle of the TE-CORE module above the magnetic disks.

For the best thermal connection from TGP to warm surface you can use a thermal compound (paste).

5. Mechanical Dimensions (mm)

Tolerances according ISO 2768-mK (medium), see table next page.

Except tolerances ± are given in the drawing.

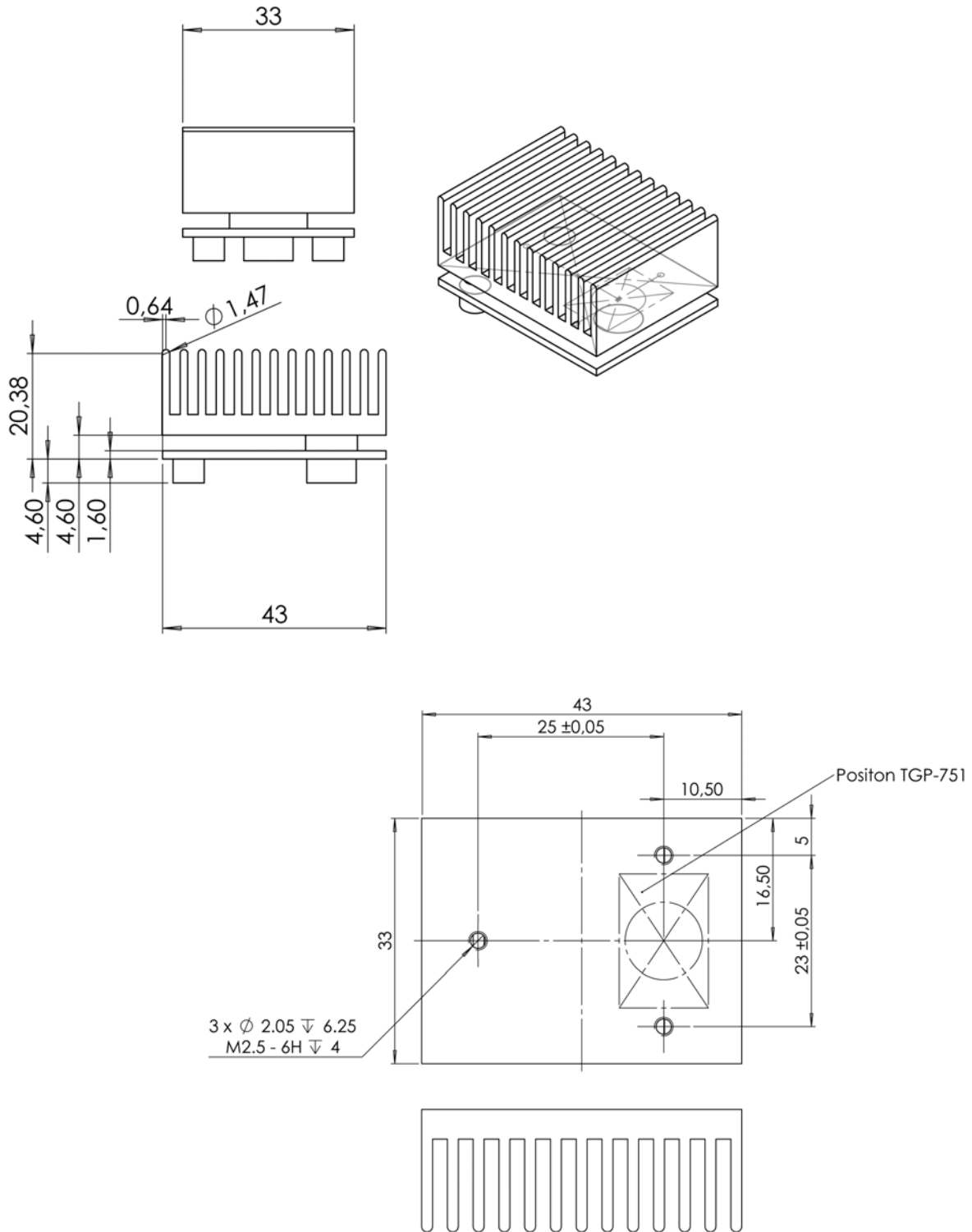

Heat sink (bottom view) position for drillings

5.1 General tolerances for linear and angular dimensions according DIN ISO 2768-mk

For TE-CORE tolerance class „medium“ is applicable.

Permissible deviations in mm for ranges in nominal lengths	Tolerance class designation (description)			v (very coarse)
	f (fine)	m (medium)	c (coarse)	
0.5 up to 3	±0.05	±0.1	±0.2	-
over 3 up to 6	±0.05	±0.1	±0.3	±0.5
over 6 up to 30	±0.1	±0.2	±0.5	±1.0
over 30 up to 120	±0.15	±0.3	±0.8	±1.5
over 120 up to 400	±0.2	±0.5	±1.2	±2.5
over 400 up to 1000	±0.3	±0.8	±2.0	±4.0
over 1000 up to 2000	±0.5	±1.2	±3.0	±6.0
over 2000 up to 4000	-	±2.0	±4.0	±8.0

6. Product Information

6.1 Reliability Testing

Micropelt TE-CORE modules will be tested according:

- Lifetime
- Humidity
- Vibration
- Mechanical shock
- Non-operating thermal shock

6.2 Environmental compliance

Micropelt TE-CORE modules are compliant to the Restriction of Hazardous Substances Directive of RoHS.

6.3 Ordering information

- TE-CORE Power harvesting kit
- TE-CORE6
- TE-CORE7



## 7. Glossary

TGP	Generator in package
AMR	Automated Meter Reading
HVAC	Heating, Ventilating and Air Conditioning
MPG-D751/D651	Micropelt thermoelectric generator type
PCB	Printed Circuit Board
TEG	Thermoelectric Generator, Thermogenerator

## 8. List of Document Changes

<b>Ver. 1.0 (2011-06.18)</b>	First version of TE-CORE datasheet
<b>Ver. 1.1 (2011-07.12)</b>	new photos of TGP and TE-CORE, few edits in the text
<b>Ver. 1.2 (2011-07.14)</b>	page 12, additional technical drawing
<b>Ver. 2.0 (2011-09.01)</b>	considerable revision of the document, additional measurements
<b>Ver. 2.1 (2011-09.02)</b>	optical improvements of diagrams and images for better pdf results
<b>Ver. 2.2 (2011-09.08)</b>	page 7, properties of TGPs, page 12, diagram DC-DC booster efficiency, page 15 mechanical drawings
<b>Ver. 2.3 (2011-09.21)</b>	page 6, table at §1.9, page 7 §2.1, page 12 §3.4.1,
<b>Ver. 2.4 (2012-04.04)</b>	page 6, Absolute max. ratings; page 7, link Fischer Elektronik, page 18 considerable up-date of thermoharvesting systems optical improvements of images
<b>Ver. 2.5 (2012-10.17)</b>	page 11, 3.1.3 thermogenerator direct access, naming of circuit control points

## Micropelt TE-CORE

## Thermoharvesting Module

### TE-CORE - DC-Power Module (only power supply)



TE-CORE thermoharvesting power module with integrated TGP, efficient DC-booster and power management functions.

### TE-CORE/RF wireless sensor evaluation kit



TE-CORE /RF is a complete thermo-powered, self-sufficient wireless sensor node system.

It offers an efficient DC-booster and power management concept with prequalified 802.15.4 compatible radio module 2.4 GHz ISM band and evaluation software.

### TE-Power PROBE



TE-Power PROBE is an integrated thermoharvester which we specifically designed for operating conditions using natural convection to ambient air.

A powerful heat sink ensures a high level of heat dissipation which leads to maximal thermoharvesting results when mounted in horizontal orientation.

### TE-qNODE



TE-qNODE is a battery-free wireless sensor for thermal monitoring of electrical distribution systems, i.e. busbars and busways.

Resistive heat is used to power continuous monitoring for increased safety and power availability in 24/7 production environments.

## 9. Important Notices – Please read carefully prior to use

### 1. Micropelt Products are prototypes

Micropelt supplies *thermoelectric* coolers and *generators*, as well as *energy harvesting modules* (hereinafter referred to as “Prototype Products”). The Prototype Products distributed by Micropelt to date are prototypes that have not yet been released to manufacturing and marketing for regular use by end-users. The Prototype Products are still being optimized and continuously tested. As such, the Prototype Products may not fully comply with design-, marketing-, and/or manufacturing-related protective considerations, including product safety and environmental measures typically found in end products that incorporate such semiconductor components or circuit boards.

In addition, the Products have not yet been fully tested for compliance with the limits of computing devices, neither pursuant to part 15 of FCC rules nor pursuant to any other national or international standards, which are designed to provide reasonable protection against radio frequency interference.

### 2. Use of Products restricted to demonstration, testing and evaluation

Micropelt’s Prototype Products are intended exclusively for the use for demonstration, testing and evaluation purposes.

The Prototype Products must not be used productively. In particular, the Prototype Products must not be used in any safety-critical applications, such as (but not limited to) life support systems, near explosion endangered sites, and/or any other performance critical systems.

The Prototype Products must only be handled by professionals in the field of electronics and engineering who are experienced in observing good engineering standards and practices.

### 3. Warnings and use instructions

- Using Micropelt’s Prototype Products without care and in the wrong context is potentially dangerous and could result in injury or damage. The Prototype Products are designed for use within closed rooms in conditions as apply for electronics such as computers; except when indicated expressively. Keep the Prototype Products away from open fire, water, chemicals, gases, explosives as well as from temperature conditions above 100 degrees centigrade, or as indicated in the datasheet of the product. When testing temperature settings at the limits given in the datasheet for longer term, do not leave the Prototype Products alone but monitor their performance. Take special care to monitor closely whenever the Prototype Products are connected to other electrical items and/or electronics.
- If Prototype Products use wireless data transmission technology, therefore they receive and radiate radio frequency energy. They have not yet been fully tested for compliance with the limits of computing devices, neither pursuant to part 15 of FCC rules nor pursuant to any other national or international standards, which are designed to provide reasonable protection against radio frequency interference. Operation of the Prototype Products may cause interference with radio communications, in which case the user at his own expense will be required to take whatever measures may be necessary to correct this interference and prevent potential damage. Do take special care not to operate the Prototype Products near safety-critical applications or any other applications known to be affected by radio frequencies.
- If any of the Prototype Products elements are separated from the complete module and used independently, it is important to control each individual system’s power supply to be within their acceptable voltage and/or amperage range. Exceeding the specified supply voltage and/or amperage range may cause unintended behavior and/or irreversible damage to the Prototype Products and/or connected applications. Please consult the Prototype Products’ datasheet prior to connecting any load to the Prototype Products’ output. Applying loads outside of the specified output range may result in unintended behavior and/or permanent damage to the Prototype Products. If there is uncertainty as to the supply or load specification, please contact a Micropelt engineer.
- During normal operation, some circuit components may have case temperatures greater than 70°C. The Prototype Products are designed to operate properly with certain components above 70°C as long as the input and output ranges are maintained. These components include but are not limited to linear regulators, switching transistors, pass transistors, and current sense resistors. These types of devices can be identified using the evaluation unit schematic located in the evaluation unit User’s Guide. When placing measurement probes near these devices during operation, please be aware that these devices may be as hot as to inflict the risk of burning skin when touched.
- Due to the open construction of the Prototype Products, it is the user’s responsibility to take any and all appropriate precautions with regard to electrostatic discharge and any other prevention measures for safety.

### 4. User’s Feedback

Micropelt welcomes the user’s feedback on the results of any tests and evaluations of the Prototype Products. In particular, we appreciate experience information on use cases with indications of strengths and weaknesses of the Prototype Products, its robustness in operation and its long-term durability. Please, contact our Micropelt Application Engineering colleagues by email at [engineering@micropelt.com](mailto:engineering@micropelt.com).

Prototype Products, its robustness in operation and its long-term durability. Please, contact our Micropelt Application Engineering colleagues by email at [engineering@micropelt.com](mailto:engineering@micropelt.com).

Micropelt GmbH | Emmy-Noether-Str. 2 | 79110 Freiburg (Germany)