



Dual N-Channel Enhancement Mode Field Effect Transistor

PRODUCT SUMMARY		
VDSS	ID	RDS(ON) (mΩ) Max
20V	9.5A	9.0 @ VGS=4.5V
		9.5 @ VGS=4.0V
		10.0 @ VGS=3.7V
		11.2 @ VGS=3.1V
		13.5 @ VGS=2.5V

FEATURES

- Super high dense cell design for low RDS(ON).
- Rugged and reliable.
- Surface Mount Package.
- ESD Protected.

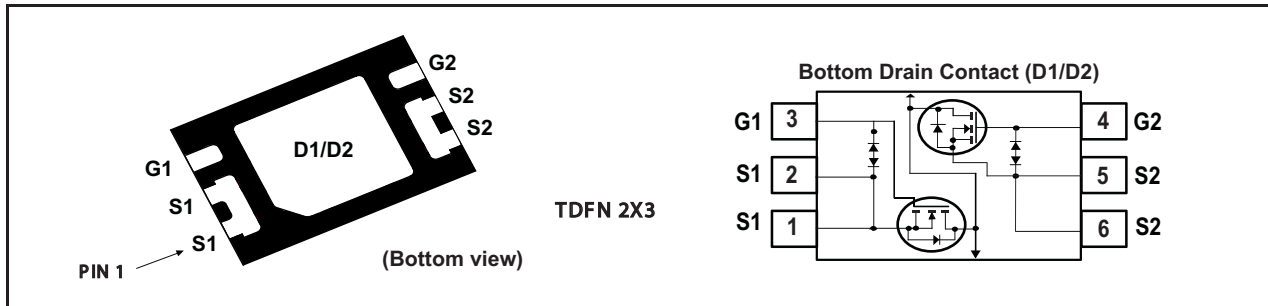

ABSOLUTE MAXIMUM RATINGS (TA=25°C unless otherwise noted)

Symbol	Parameter	Limit	Units
V _{DS}	Drain-Source Voltage	20	V
V _{GS}	Gate-Source Voltage	±12	V
I _D	Drain Current-Continuous ^c	T _A =25°C	9.5
		T _A =70°C	7.6
I _{DM}	-Pulsed ^{a c}	60	A
P _D	Maximum Power Dissipation	T _A =25°C	1.56
		T _A =70°C	1.00
T _J , T _{STG}	Operating Junction and Storage Temperature Range	-55 to 150	°C

THERMAL CHARACTERISTICS

R _{θJA}	Thermal Resistance, Junction-to-Ambient	80	°C/W
------------------	---	----	------

STF8204

Ver 2.1

ELECTRICAL CHARACTERISTICS (TA=25°C unless otherwise noted)

Symbol	Parameter	Conditions	Min	Typ	Max	Units
OFF CHARACTERISTICS						
BV _{DSS}	Drain-Source Breakdown Voltage	V _{GS} =0V , I _D =250uA	20			V
I _{DSS}	Zero Gate Voltage Drain Current	V _{DS} =18V , V _{GS} =0V			1	uA
I _{GSS}	Gate-Body Leakage Current	V _{GS} = ±8V , V _{DS} =0V			±1	uA
ON CHARACTERISTICS						
V _{GS(th)}	Gate Threshold Voltage	V _{DS} =V _{GS} , I _D =1.0mA	0.5	0.85	1.5	V
R _{DS(ON)}	Drain-Source On-State Resistance	V _{GS} =4.5V , I _D =2.4A	6.3	7.8	9.0	m ohm
		V _{GS} =4.0V , I _D =2.4A	6.5	8.0	9.5	m ohm
		V _{GS} =3.7V , I _D =2.4A	6.7	8.2	10.0	m ohm
		V _{GS} =3.1V , I _D =2.4A	7.0	9.0	11.2	m ohm
		V _{GS} =2.5V , I _D =2.4A	8.0	10.5	13.5	m ohm
g _{FS}	Forward Transconductance	V _{DS} =5V , I _D =4.75A		28		S
DYNAMIC CHARACTERISTICS^b						
C _{ISS}	Input Capacitance	V _{DS} =10V, V _{GS} =0V f=1.0MHz		980		pF
C _{OSS}	Output Capacitance			213		pF
C _{RSS}	Reverse Transfer Capacitance			189		pF
SWITCHING CHARACTERISTICS^b						
t _{D(ON)}	Turn-On Delay Time	V _{DD} =16V I _D =4.75A V _{GS} =4.5V R _{GEN} = 6 ohm		24		ns
t _r	Rise Time			66		ns
t _{D(OFF)}	Turn-Off Delay Time			116		ns
t _f	Fall Time			46		ns
Q _g	Total Gate Charge			10.7		nC
Q _{gs}	Gate-Source Charge	V _{DS} =16V, I _D =9.5A, V _{GS} =4.5V		2.1		nC
Q _{gd}	Gate-Drain Charge			5.4		nC
DRAIN-SOURCE DIODE CHARACTERISTICS AND MAXIMUM RATINGS						
V _{SD}	Diode Forward Voltage	V _{GS} =0V, I _S =9.5A		0.84	1.2	V

Notes

- a. Pulse Test: Pulse Width ≤ 10us, Duty Cycle ≤ 1%.
- b. Guaranteed by design, not subject to production testing.
- c. Drain current limited by maximum junction temperature.
- d. Mounted on FR4 Board of 1 inch² , 2oz.

Jul, 18, 2014

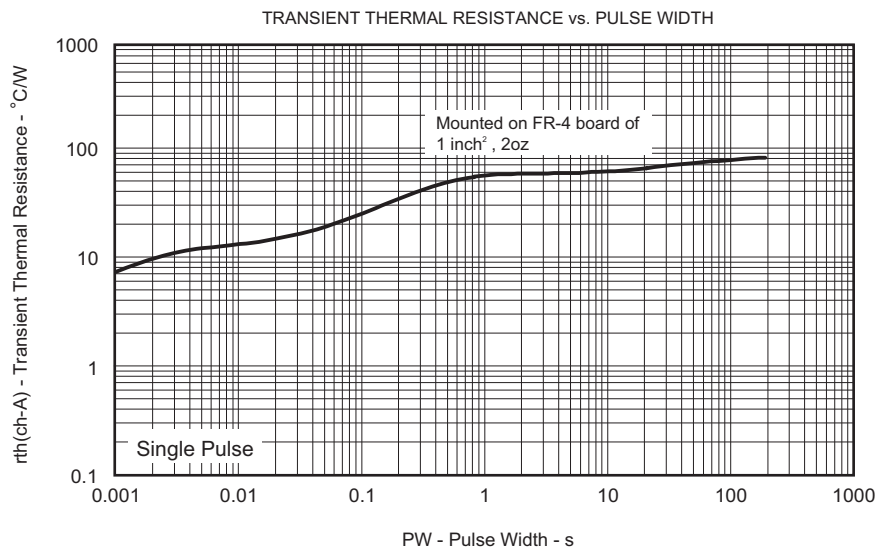
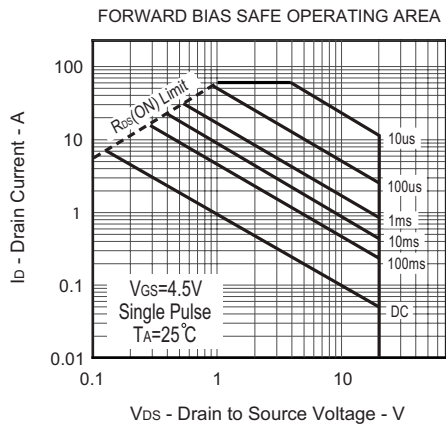
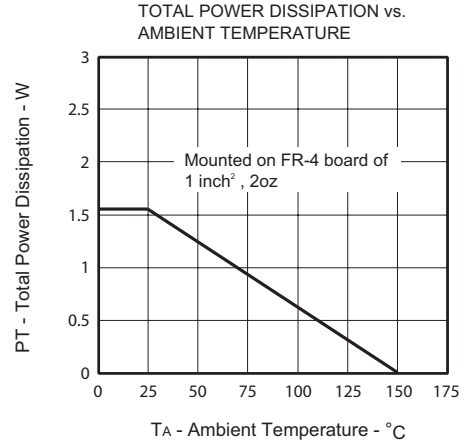
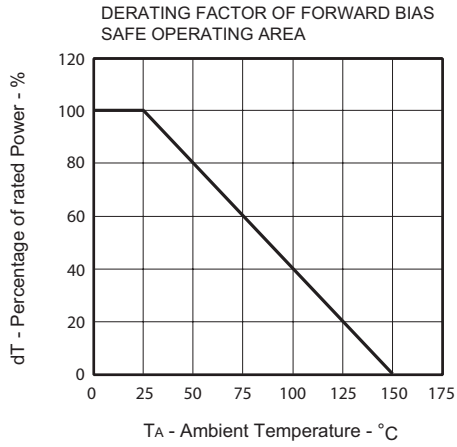

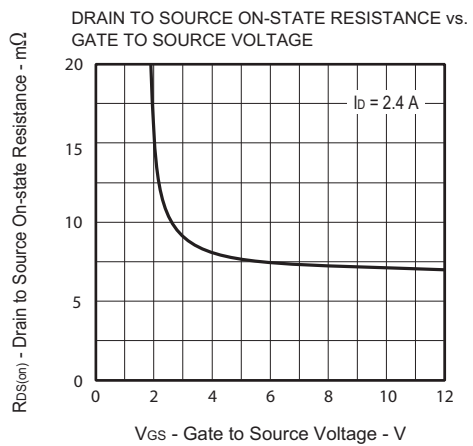
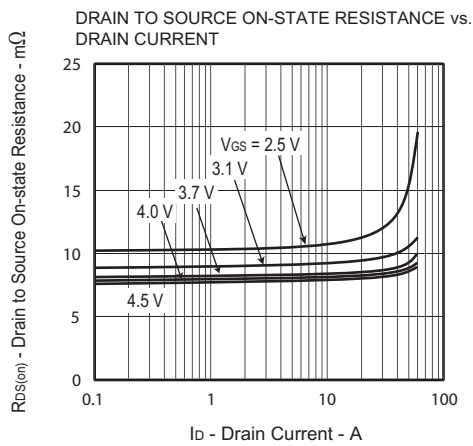
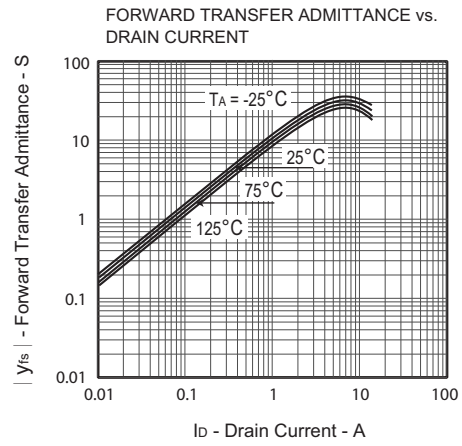
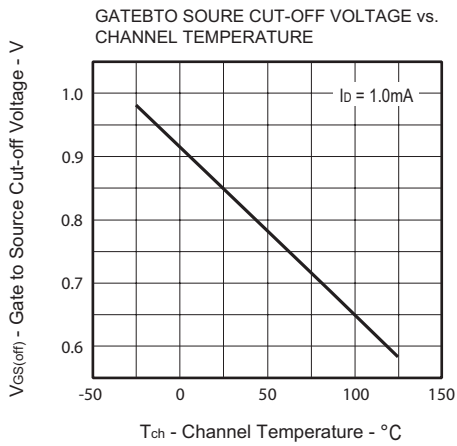
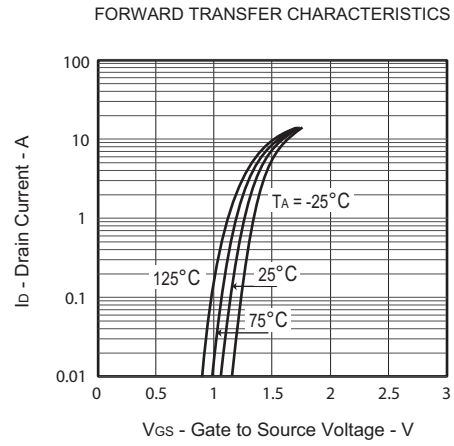
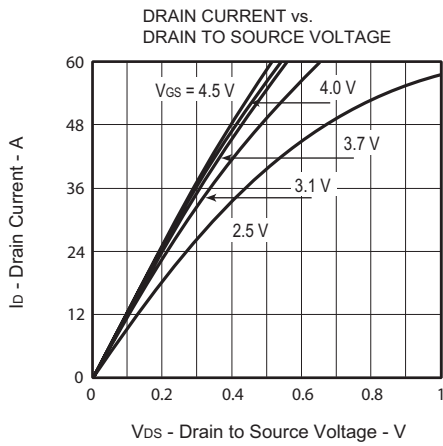

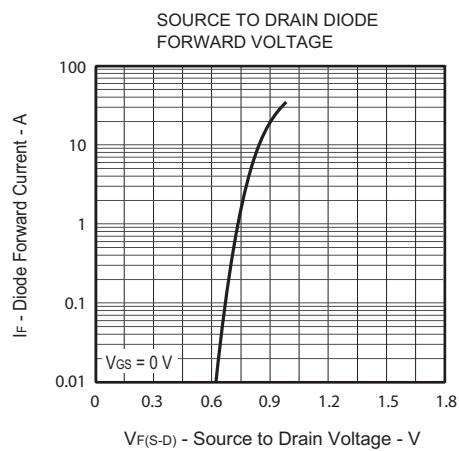
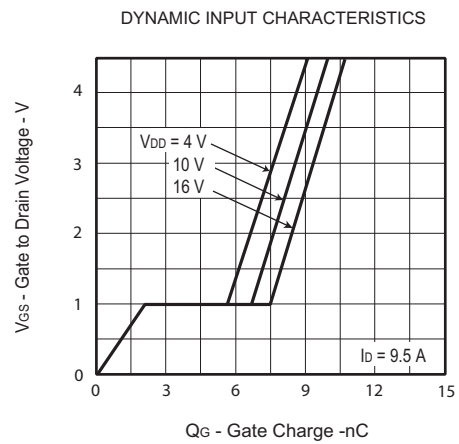
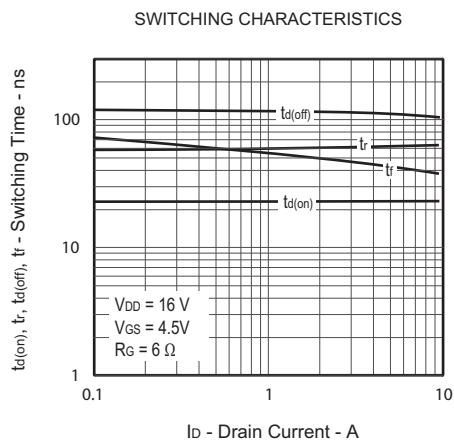
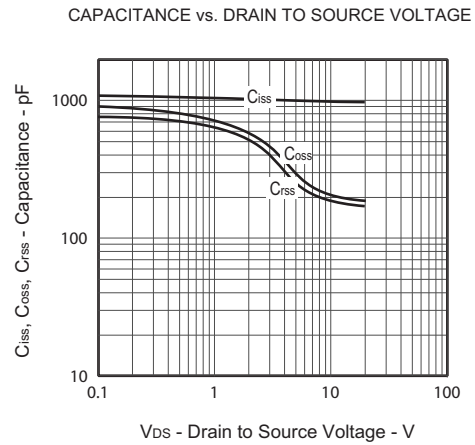
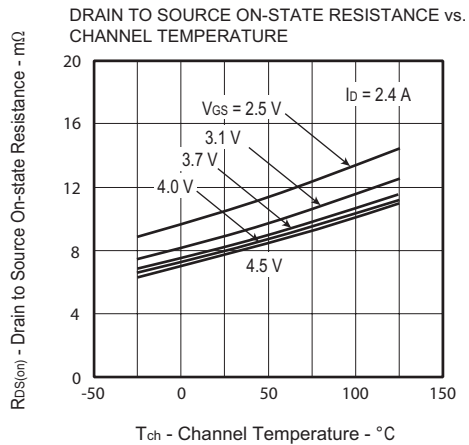

PACKAGE OUTLINE DIMENSIONS

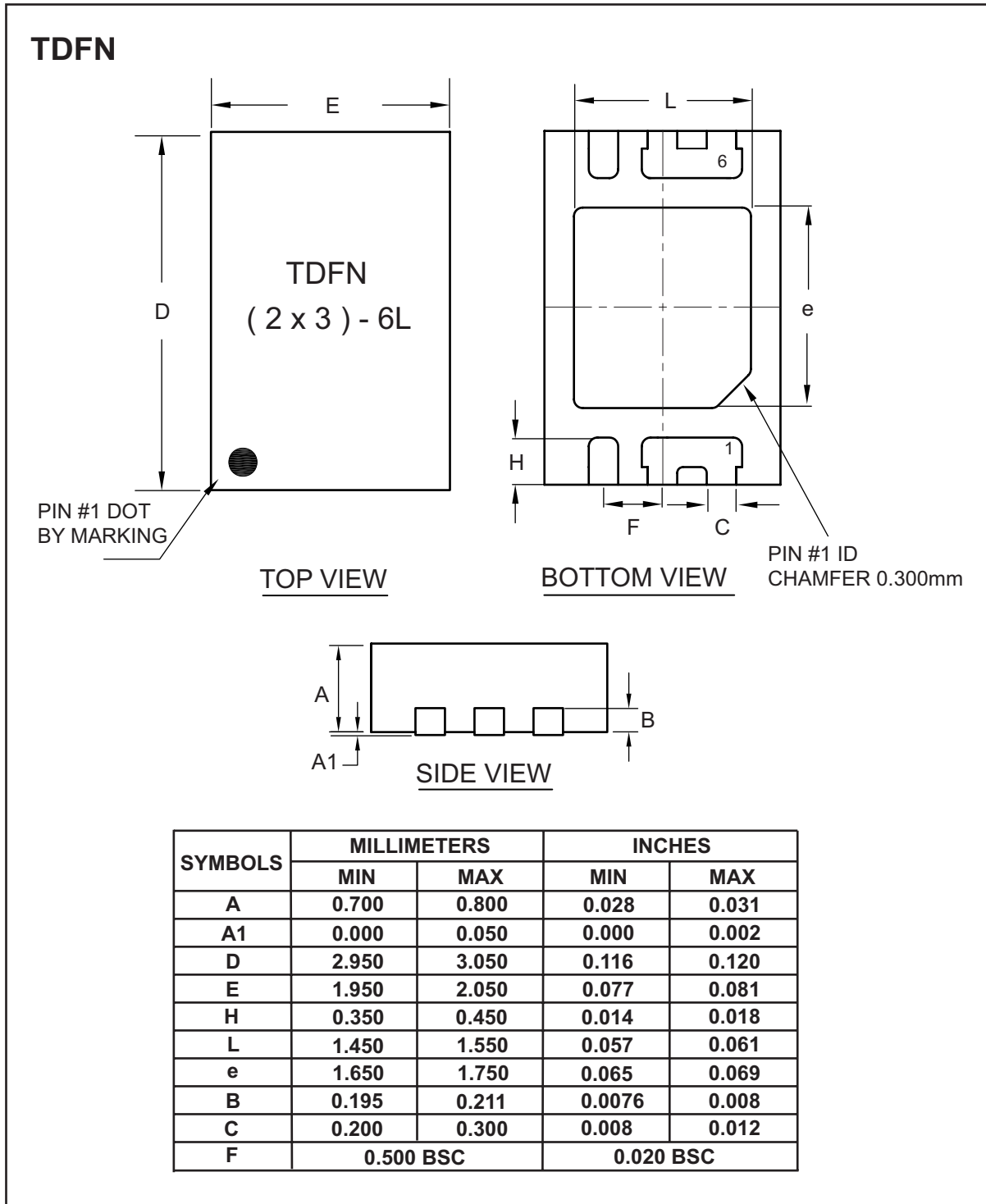

TDFN 2x3-6L Tape

TDFN 2x3-6L Tape and Reel Data

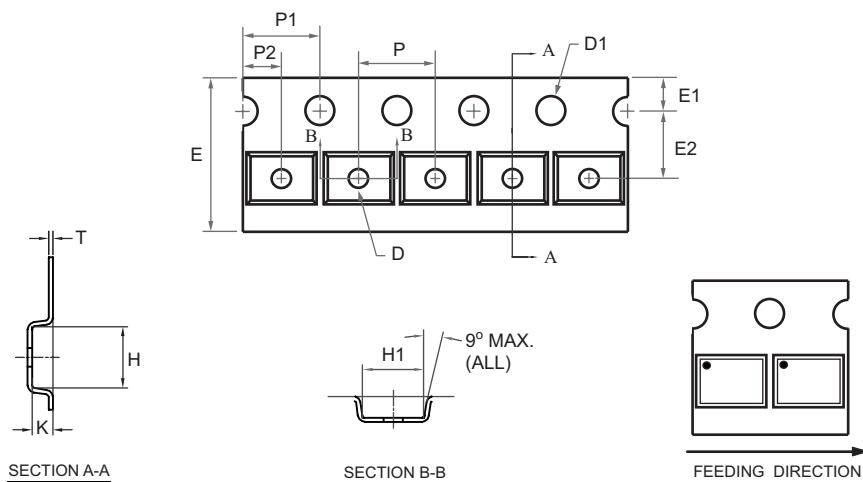

UNIT : mm

PACKAGE	D	D1	E	E1	E2	H	H1	K	P	P1	P2	T
TDFN 2x3-6L	$\phi 1.00$ +0.25 -0.00	$\phi 1.50$ +0.10 -0.00	8.00 +0.30 -0.10	1.75 ± 0.10	3.50 ± 0.05	2.31 ± 0.10	3.29 ± 0.10	1.10 ± 0.10	4.00 ± 0.10	4.00 ± 0.10	2.00 ± 0.05	0.254 ± 0.02

S mini 8 Reel

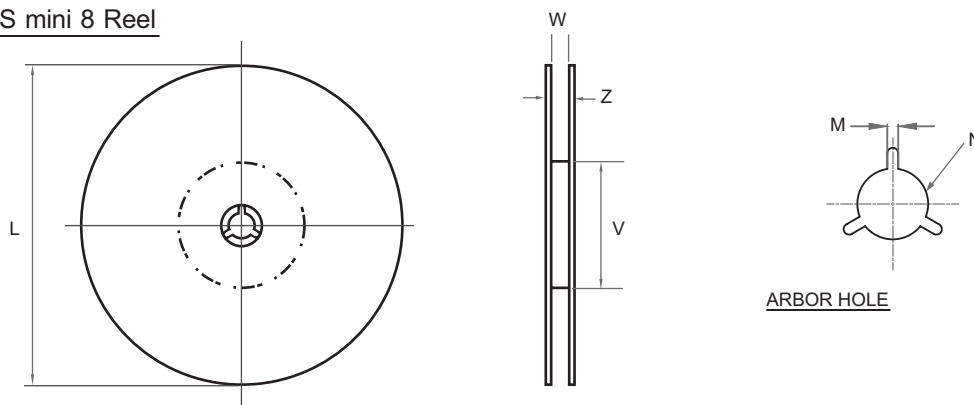

UNIT : mm

TAPE SIZE	REEL SIZE	M	N	W	V	Z	L
8 mm	7 INCH	1.5 (min)	1.28 ~ 13.5	8.4 ~ 9.9	54.5 ~ 55.5	14.4 (max)	178.5 ~ 179.5

PACKAGE OUTLINE DIMENSIONS

