



N-Channel Enhancement Mode Field Effect Transistor

PRODUCT SUMMARY

V _{DSS}	I _D	R _{DS(ON)} (Ω) Typ
200V	2A	2.5 @ V _{GS} =10V

FEATURES

- Super high dense cell design for low R_{DS(ON)}.
- Rugged and reliable.
- Surface Mount Package.

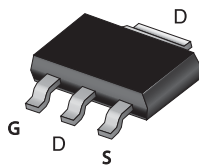

SOT-223

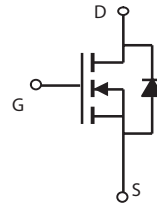

ABSOLUTE MAXIMUM RATINGS (T_A=25°C unless otherwise noted)

Symbol	Parameter	Limit	Units
V _{DS}	Drain-Source Voltage	200	V
V _{GS}	Gate-Source Voltage	±30	V
I _D	Drain Current-Continuous	2	A
I _{DM}	-Pulsed ^a	13	A
P _D	Maximum Power Dissipation ^a	2.98	W
T _J , T _{STG}	Operating Junction and Storage Temperature Range	-55 to 175	°C

THERMAL CHARACTERISTICS

R _{θJA}	Thermal Resistance, Junction-to-Ambient	42	°C/W
------------------	---	----	------

SDT02N02

Ver 1.0

ELECTRICAL CHARACTERISTICS (T_A=25°C unless otherwise noted)

Symbol	Parameter	Conditions	Min	Typ	Max	Units
OFF CHARACTERISTICS						
BV _{DSS}	Drain-Source Breakdown Voltage	V _{GS} =0V , I _D =250uA	200			V
I _{DSS}	Zero Gate Voltage Drain Current	V _{DS} =160V , V _{GS} =0V			1	uA
I _{GSS}	Gate-Body Leakage Current	V _{GS} = ±30V , V _{DS} =0V			±100	nA
ON CHARACTERISTICS						
V _{GS(th)}	Gate Threshold Voltage	V _{DS} =V _{GS} , I _D =250uA	2	3	4	V
R _{DS(ON)}	Drain-Source On-State Resistance	V _{GS} =10V , I _D =1A		2.5	3.1	ohm
g _{FS}	Forward Transconductance	V _{DS} =10V , I _D =1A		1.8		S
DYNAMIC CHARACTERISTICS ^b						
C _{ISS}	Input Capacitance	V _{DS} =25V, V _{GS} =0V f=1.0MHz		240		pF
C _{OSS}	Output Capacitance			38		pF
C _{RSS}	Reverse Transfer Capacitance			8		pF
SWITCHING CHARACTERISTICS ^b						
t _{D(ON)}	Turn-On Delay Time	V _{DD} =100V I _D =1A V _{GS} =10V R _{GEN} =6 ohm		14.5		ns
t _r	Rise Time			9		ns
t _{D(OFF)}	Turn-Off Delay Time			17		ns
t _f	Fall Time			4.5		ns
Q _g	Total Gate Charge	V _{DS} =100V, I _D =1A, V _{GS} =10V		5.5		nC
Q _{gs}	Gate-Source Charge	V _{DS} =100V, I _D =1A, V _{GS} =10V		1.5		nC
Q _{gd}	Gate-Drain Charge			2		nC
DRAIN-SOURCE DIODE CHARACTERISTICS AND MAXIMUM RATINGS						
V _{SD}	Diode Forward Voltage	V _{GS} =0V, I _S =1A		0.78	1.4	V

Notes

- a. Pulse Test: Pulse Width < 300us, Duty Cycle < 2%.
b. Guaranteed by design, not subject to production testing.

Jun,07,2012

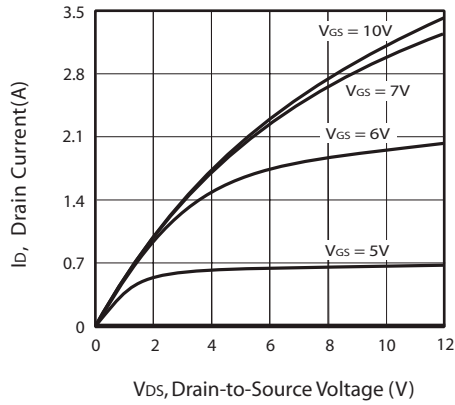

Figure 1. Output Characteristics

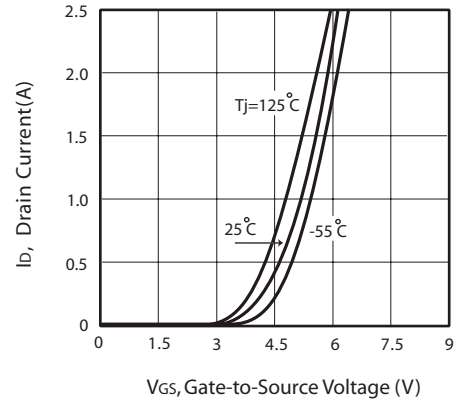

Figure 2. Transfer Characteristics

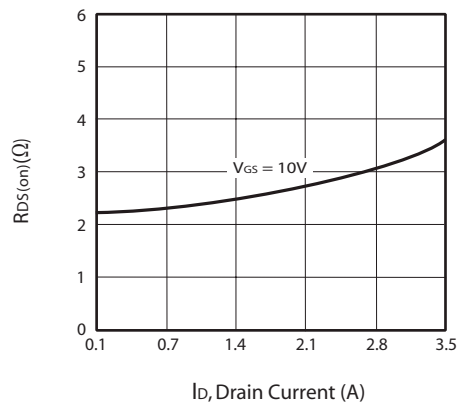

Figure 3. On-Resistance vs. Drain Current and Gate Voltage

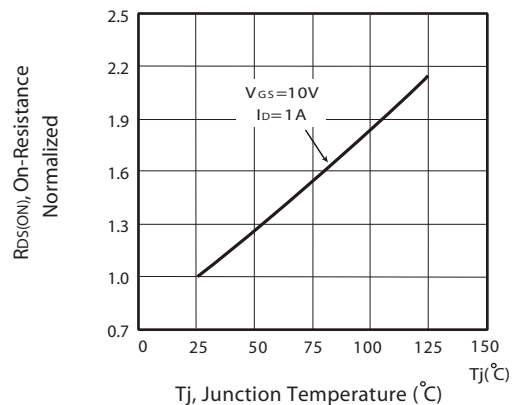

Figure 4. On-Resistance Variation with Drain Current and Temperature

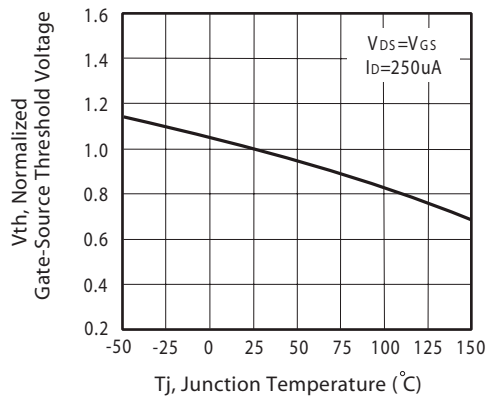

Figure 5. Gate Threshold Variation with Temperature

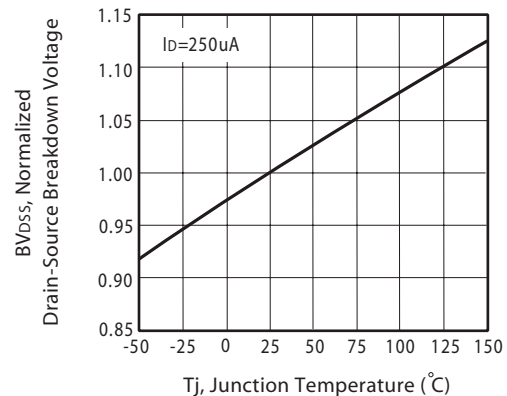

Figure 6. Breakdown Voltage Variation with Temperature

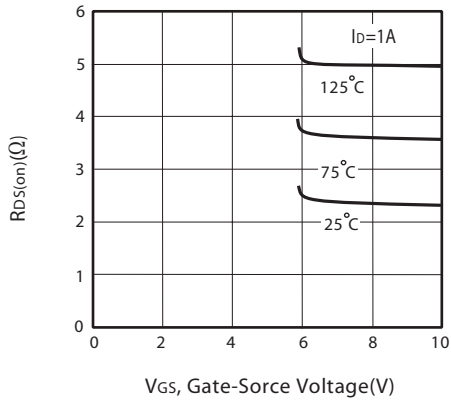

Figure 7. On-Resistance vs. Gate-Source Voltage

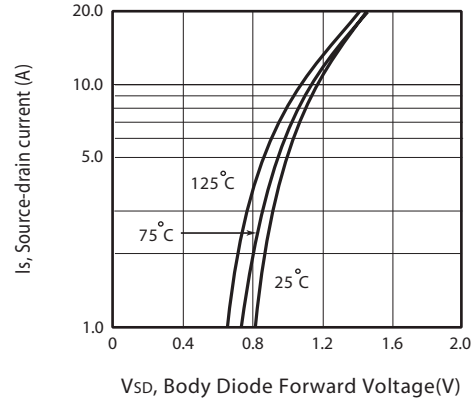

Figure 8. Body Diode Forward Voltage Variation with Source Current

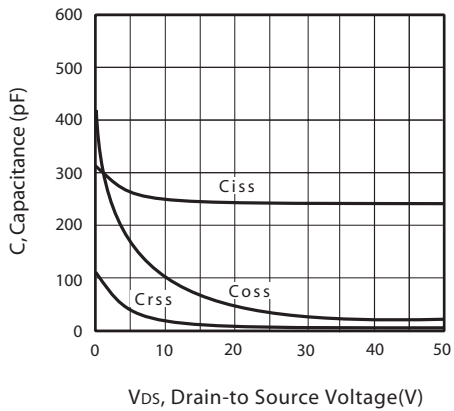

Figure 9. Capacitance

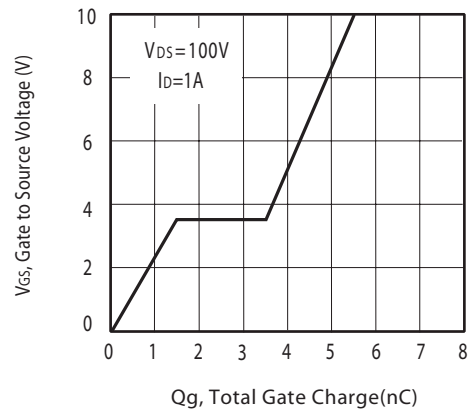

Figure 10. Gate Charge

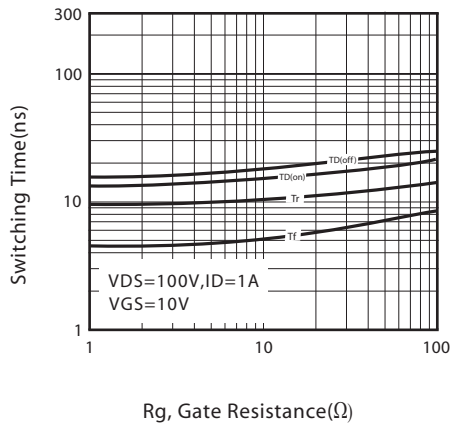

Figure 11. switching characteristics

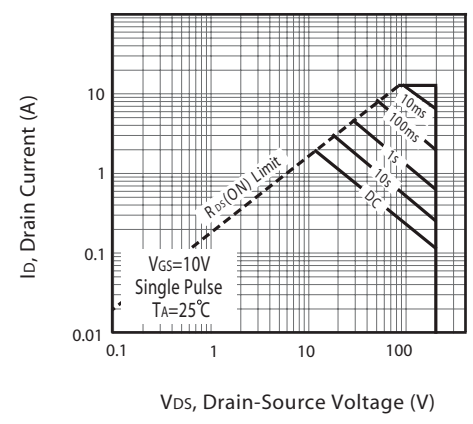

Figure 12. Maximum Safe Operating Area

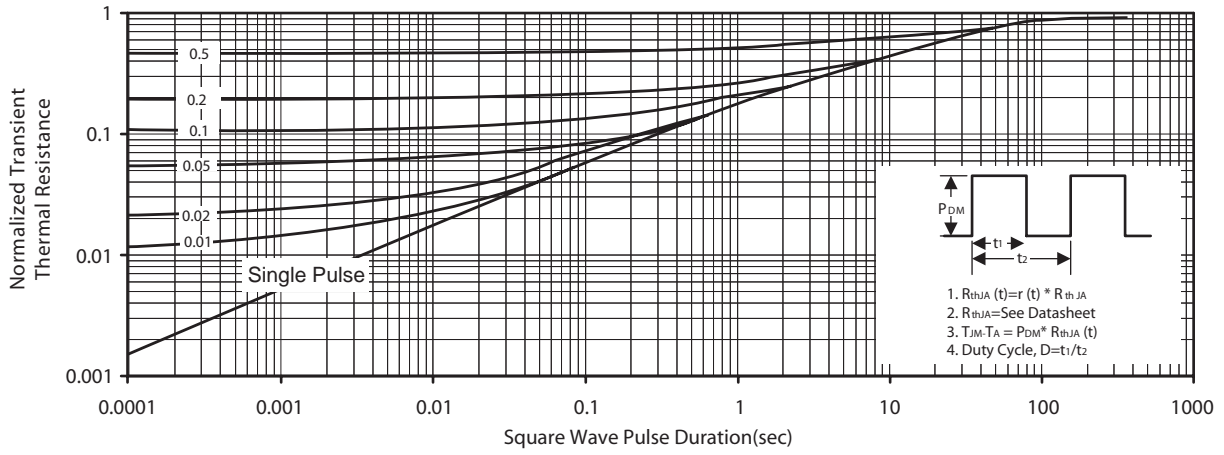
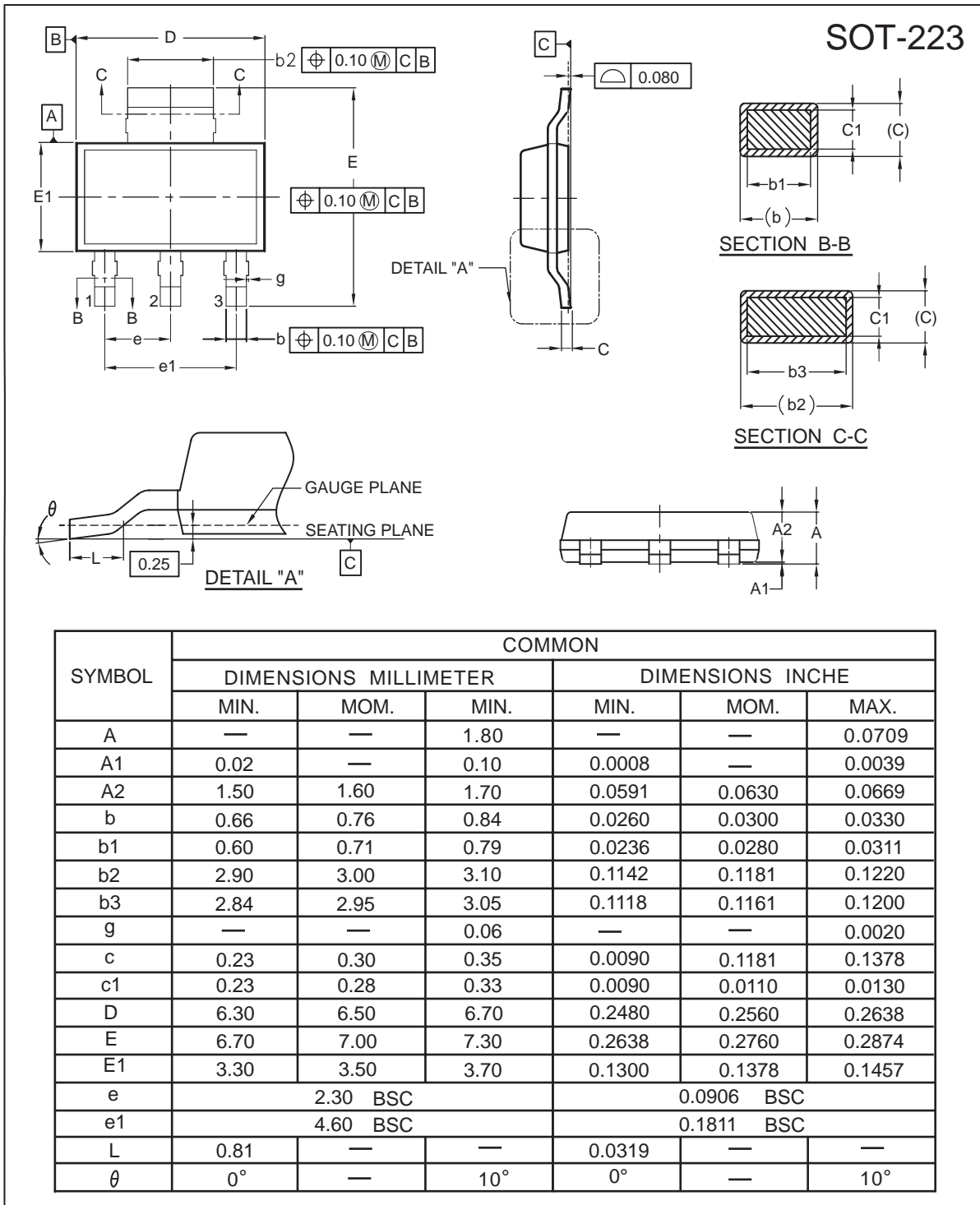

Figure 13. Normalized Thermal Transient Impedance Curve

SDT02N02

Ver1.1



Jun,07,2012

SOT-223 Tape and Reel Data

SOT-223 Carrier Tape

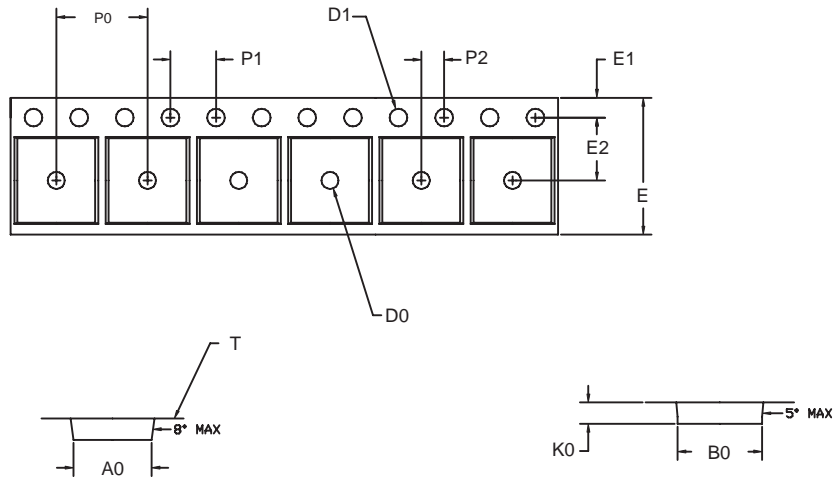

unit:mm

PACKAGE	A0	B0	K0	D0	D1	E	E1	E2	P0	P1	P2	T
---	6.83 ±0.1	7.42 ±0.1	1.88 ±0.1	1.50 +0.25	1.60 +0.1	12.0 +0.3 -0.1	1.75 ±0.1	5.50 ±0.5	8.0 ±0.1	4.00 ±0.1	2.00 ±0.05	0.292 ±0.02

SOT-223 Reel

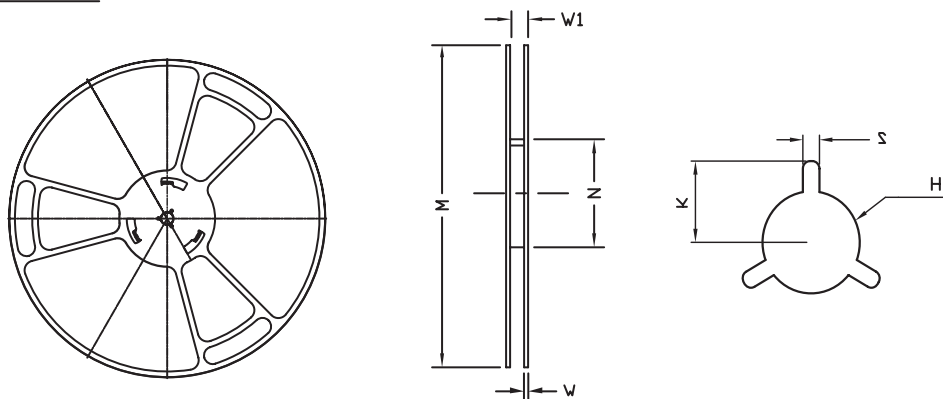

UNIT:mm

REEL SIZE	M	N	W	W1	H	K	S	G	R	V
φ 330 ± 0.5	---	φ 97.0 ± 1.0	2.2	13.0 + 1.5	φ 13.0 + 0.5 - 0.2	10.6	2.0 ± 0.5	---	---	---