

## LOW DROPOUT VOLTAGE REGULATOR WITH ON/OFF CONTROL

### ■ GENERAL DESCRIPTION

The NJM2386/88 is a general purpose low dropout voltage regulators with ON/OFF control.

The output current is up to 1.0A and dropout voltage is 0.2V typical at 500mA load.

It features high maximum input voltage of 35V for a wide application range including TV, home appliances and power modules.

### ■ PACKAGE OUTLINE

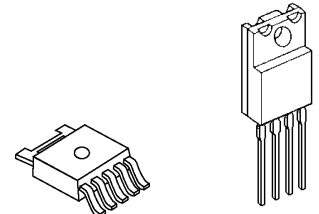

NJM2386DL3

NJM2388F

### ■ FEATURES

- High Maximum Input Voltage Up to 35V
- Low Dropout Voltage 0.2V typ. at  $I_o=0.5A$
- Output Current  $I_o(max.)=1.0A$
- ON/OFF Control (Active High)
- Internal Short Circuit Current Limit
- Internal Overvoltage Protection
- Internal Thermal Overload Protection
- Bipolar Technology
- Package Outline TO-252-5(NJM2386), TO-220F-4(NJM2388)

### ■ PIN CONFIGURATION

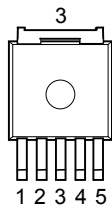

NJM2386DL3

- PIN FUNCTION**
1.  $V_{IN}$
  2. ON/OFF CONTROL
  3.  $V_{OUT}$
  4. N.C.
  5. GND

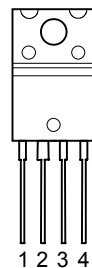

NJM2388F

- PIN FUNCTION**
1.  $V_{IN}$
  2.  $V_{OUT}$
  3. GND
  4. ON/OFF CONTROL

### ■ EQUIVALENT CIRCUIT

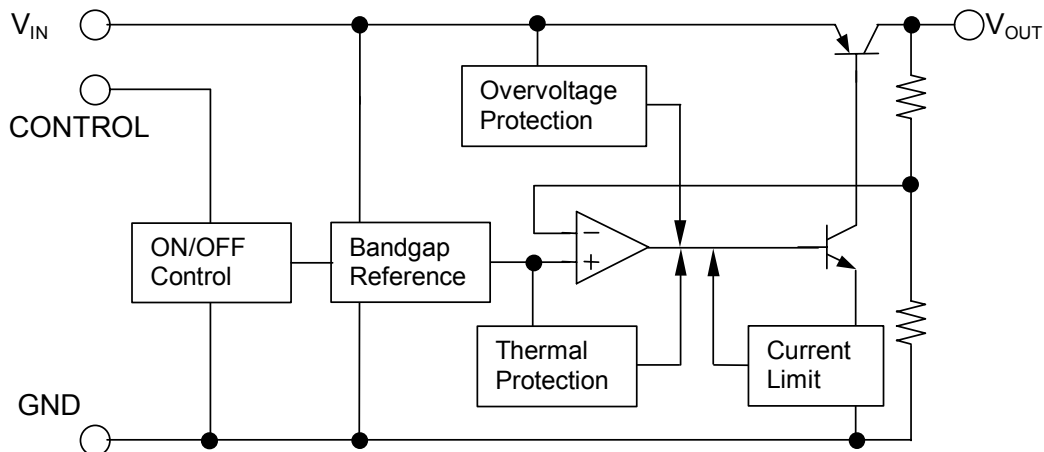

# NJM2386/88

## ■ OUTPUT VOLTAGE RANK LIST

Device Name	V <sub>OUT</sub>
NJM2386DL3-33	3.3V
NJM2386DL3-05	5.0V
NJM2386DL3-63	6.3V
NJM2386DL3-08	8.0V
NJM2386DL3-09	9.0V
NJM2386DL3-12	12.0V

Device Name	V <sub>OUT</sub>
NJM2388F33	3.3V
NJM2388F05	5.0V
NJM2388F63	6.3V
NJM2388F08	8.0V
NJM2388F84	8.4V
NJM2388F09	9.0V
NJM2388F10	10.0V
NJM2388F12	12.0V

## ■ ABSOLUTE MAXIMUM RATINGS

(Ta=25°C)

PARAMETER	SYMBOL	RATINGS		UNIT
Input Voltage	V <sub>IN</sub>	+35		V
Control Voltage	V <sub>CONT</sub>	+35(*1)		V
Output Current	I <sub>o</sub>	1.0		A
Power Dissipation	P <sub>D</sub>	NJM2386	10(Tc<25°C) / 1(Ta<25°C)	W
		NJM2388	18(Tc<50°C)	
Operating Junction Temperature Range	T <sub>j</sub>	-40 ~ +150		°C
Operating Temperature Range	T <sub>opr</sub>	-40 ~ +85		°C
Storage Temperature Range	T <sub>stg</sub>	-50 ~ +150		°C

(\*1): When input voltage is less than +35V, the absolute maximum control voltage is equal to the input voltage.

## ■ ELECTRICAL CHARACTERISTICS (V<sub>IN</sub>=V<sub>O</sub>+1V, I<sub>o</sub>=0.5A, C<sub>IN</sub>=0.33μF, C<sub>O</sub>=22μF, Ta=25°C)

Measurement is to be conducted is pulse testing.

PARAMETER	SYMBOL	CONDITIONS	MIN.	TYP.	MAX.	UNIT
Output Voltage	V <sub>o</sub>	V <sub>IN</sub> =V <sub>O</sub> +1V	-2%	-	+2%	V
Line Regulation	ΔV <sub>o</sub> /ΔV <sub>IN</sub>	V <sub>IN</sub> =V <sub>O</sub> +1V ~ V <sub>O</sub> +17V	-	0.04	0.16	%/V
Load Regulation	ΔV <sub>o</sub> /ΔI <sub>o</sub>	V <sub>IN</sub> =V <sub>O</sub> +2V, I <sub>o</sub> =0A ~ 1.0A	-	0.2	1.4	%/A
Average Temperature Coefficient of Output Voltage	ΔV <sub>o</sub> /ΔT	T <sub>j</sub> =0 ~ +125°C	-	±0.02	-	%/°C
Quiescent Current	I <sub>Q</sub>	I <sub>o</sub> =0A	-	-	5	mA
Quiescent Current at Control OFF(*2)	I <sub>Q(OFF)</sub>	V <sub>CONT</sub> =0V	-	-	500	μA
Dropout Voltage	ΔV <sub>I-O</sub>	I <sub>o</sub> =0.5A	-	0.2	0.5	V
Ripple Rejection	NJM238**33	RR V <sub>IN</sub> =V <sub>O</sub> +2V, e <sub>in</sub> =0.5V <sub>rms</sub> , f=120Hz	54	67	-	dB
	NJM238**05		54	67	-	
	NJM238**63		54	67	-	
	NJM238**08		52	65	-	
	NJM238**84		52	65	-	
	NJM238**09		52	65	-	
	NJM238**10		50	63	-	
NJM238**12	50	63	-			
ON Control Voltage	V <sub>CONT(ON)</sub>		2.0(*3)	-	-	V
OFF Control Voltage	V <sub>CONT(OFF)</sub>		-	-	0.4	V
ON Control Current	I <sub>CONT(ON)</sub>	V <sub>C</sub> =2.7V	-	-	20	μA
OFF Control Current	I <sub>CONT(OFF)</sub>	V <sub>C</sub> =0.4V	-	-	-20	μA

(\*2) This electrical characteristics is applied to NJM2388.

(\*3): When ON/OFF CONTROL Terminal is open, Output Voltage is ON.

## POWER DISSIPATION vs. AMBIENT TEMPERATURE

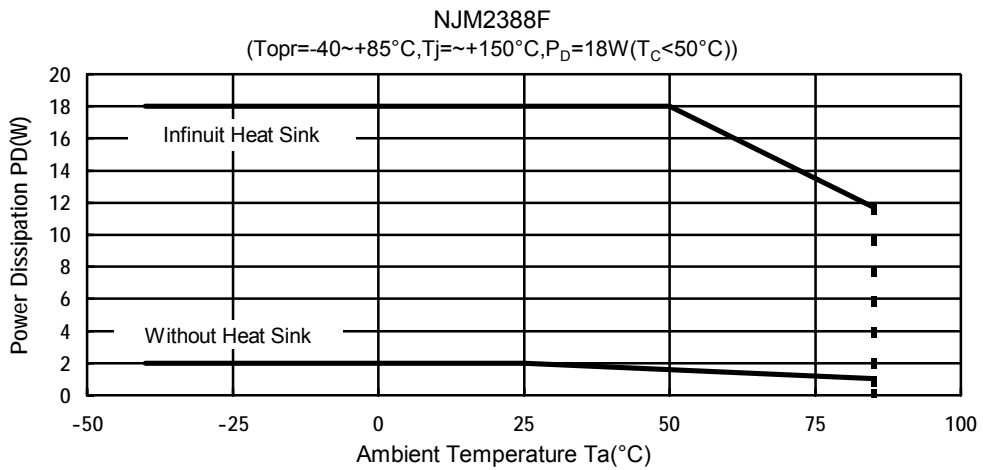
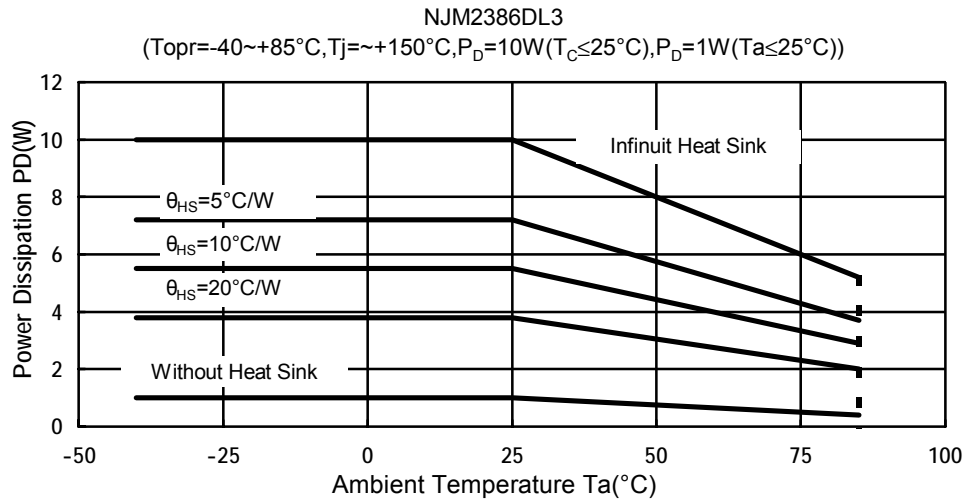

## TEST CIRCUIT

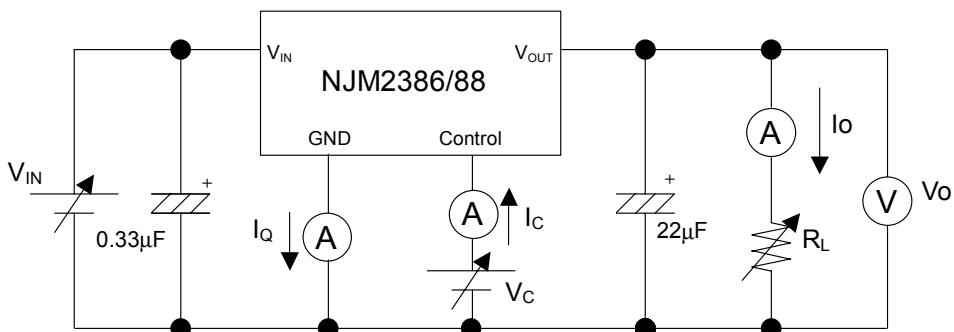

# NJM2386/88

## ■ TYPICAL APPLICATION

① In the case where ON/OFF Control is not required:

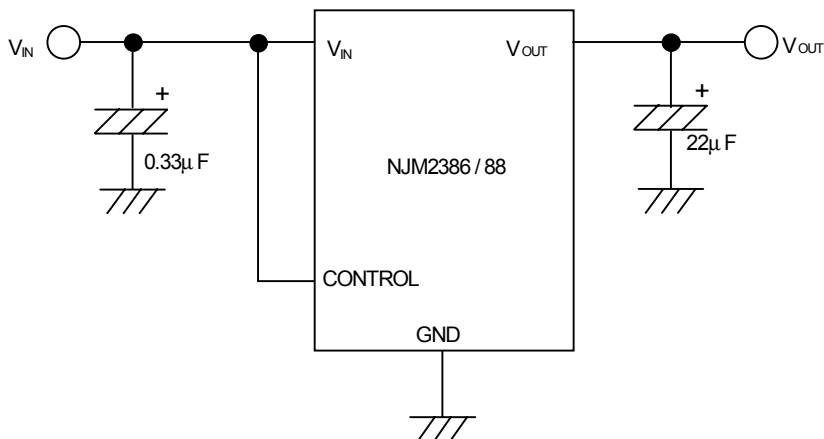

Connect control terminal to  $V_{IN}$  terminal or open.

② In use of ON/OFF CONTROL:

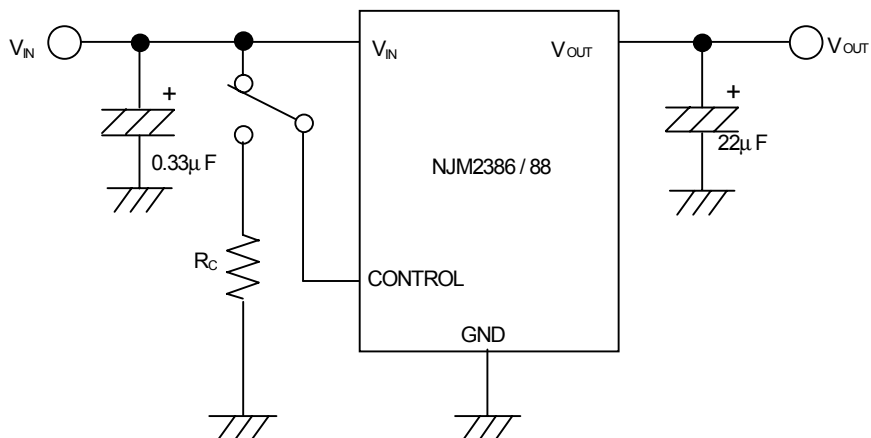

State of control terminal:

- “H” or “open” → output is enabled.
- “L” → output is disabled.

## TYPICAL CHARACTERISTICS

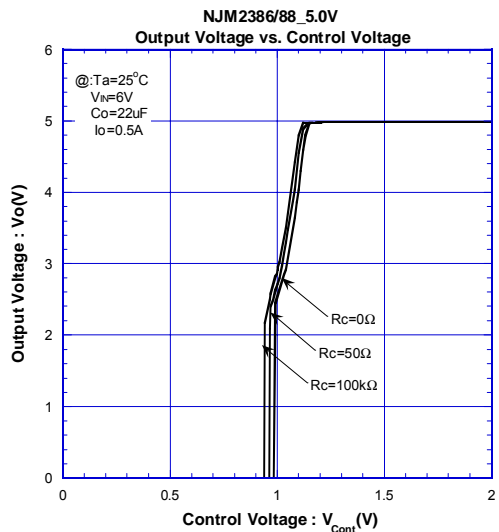
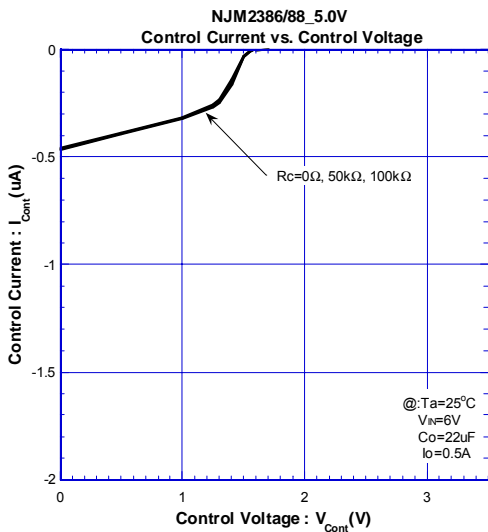
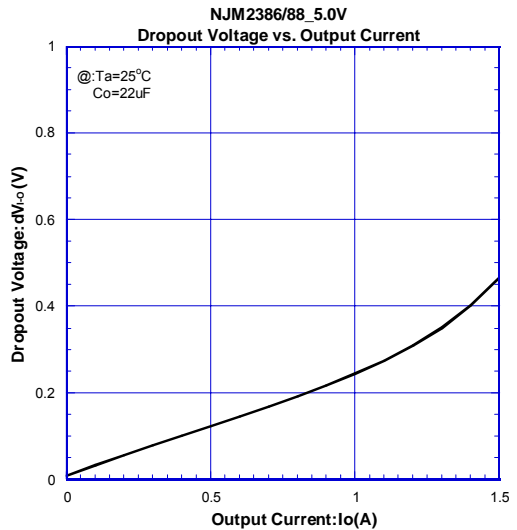
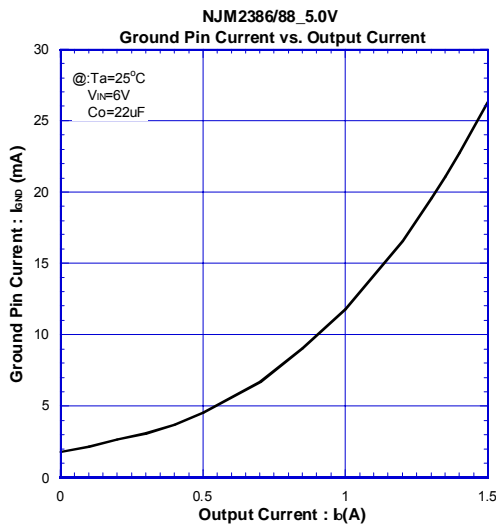
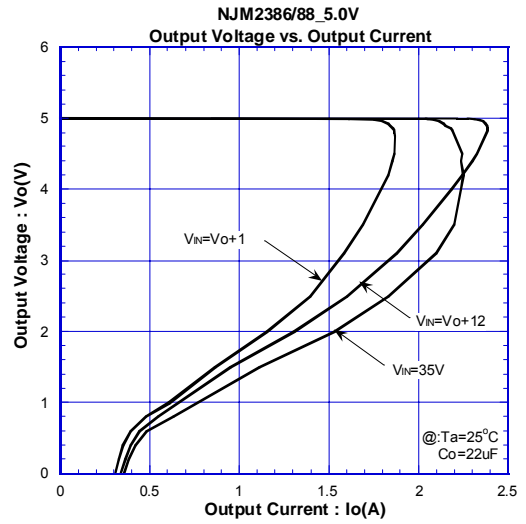
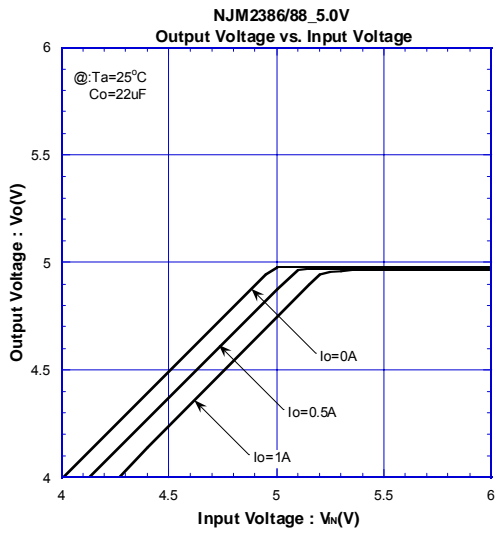

# NJM2386/88

## TYPICAL CHARACTERISTICS

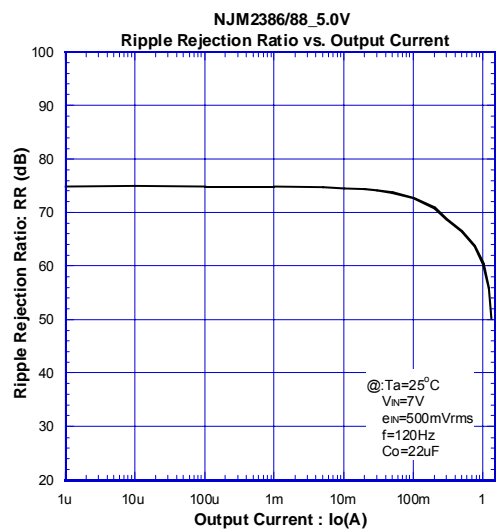
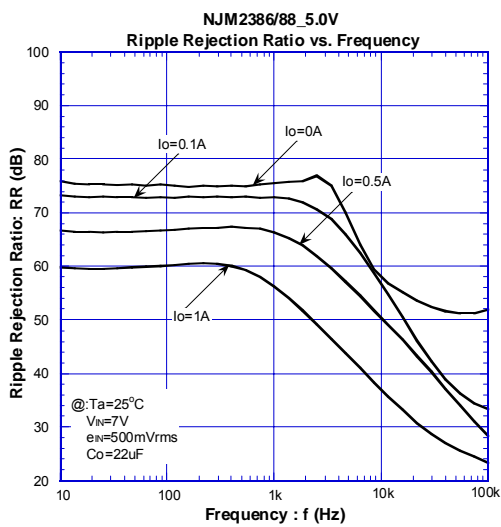
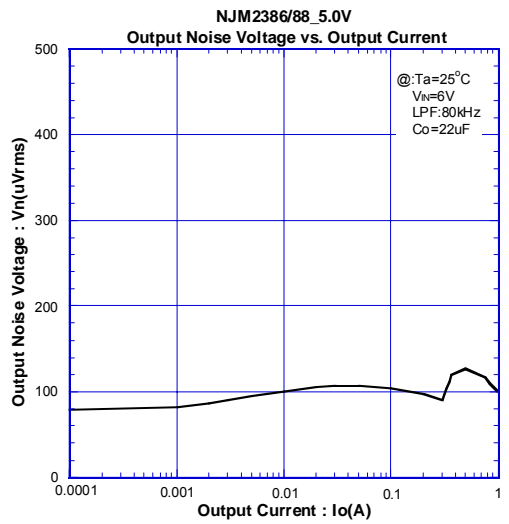
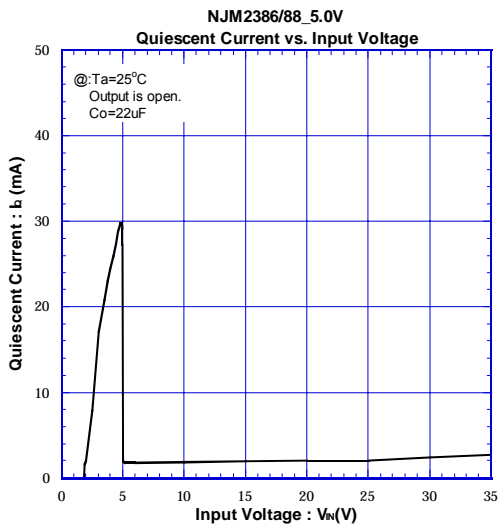
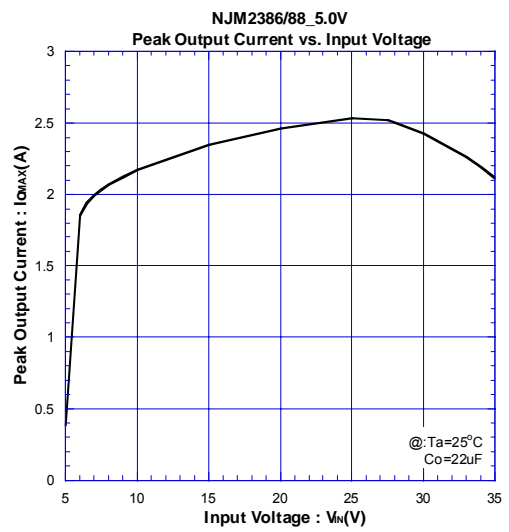
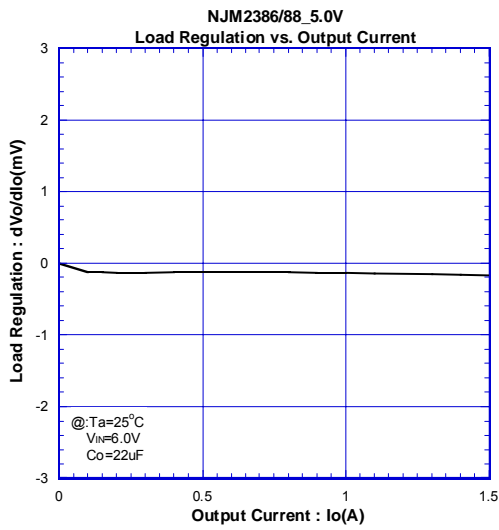

## TYPICAL CHARACTERISTICS

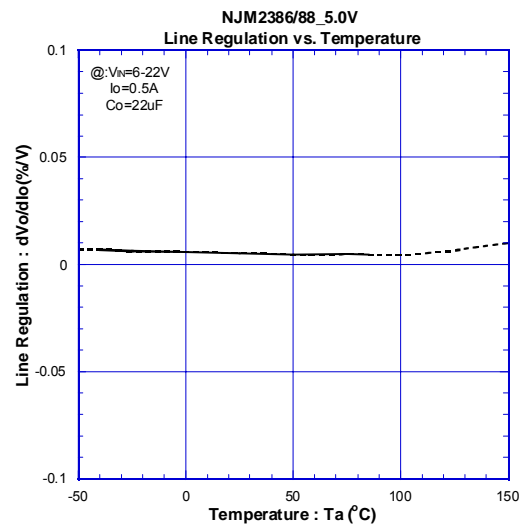
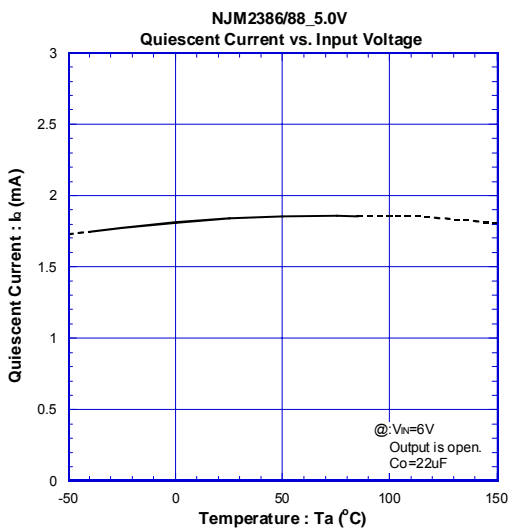
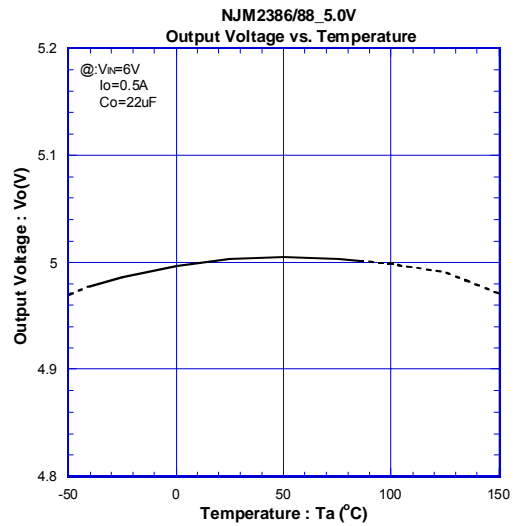
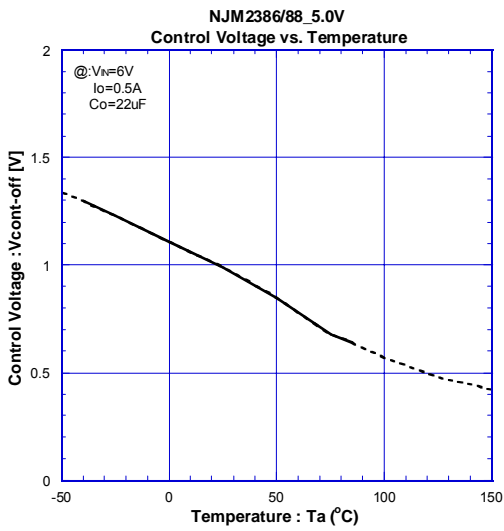
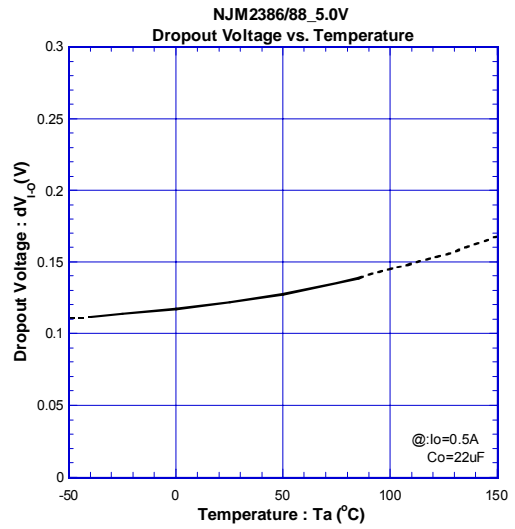
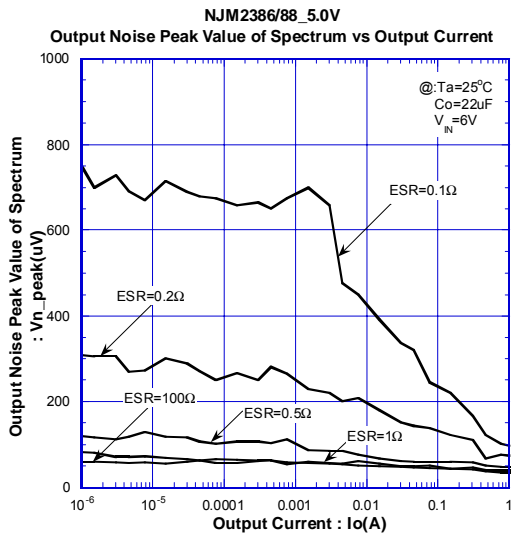

# NJM2386/88

## TYPICAL CHARACTERISTICS

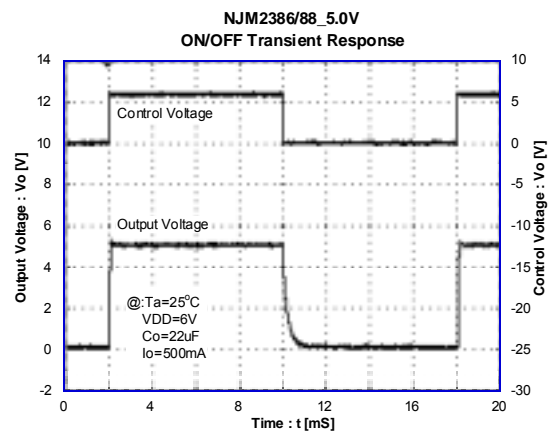
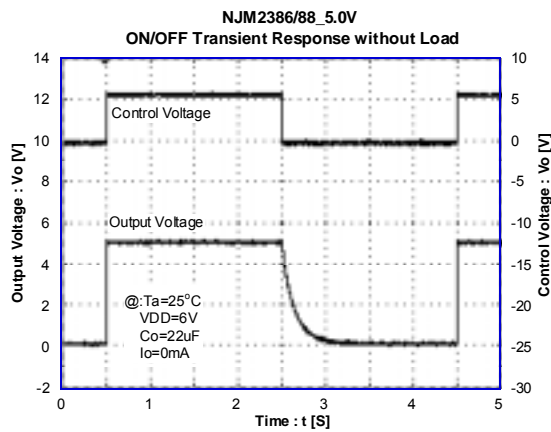
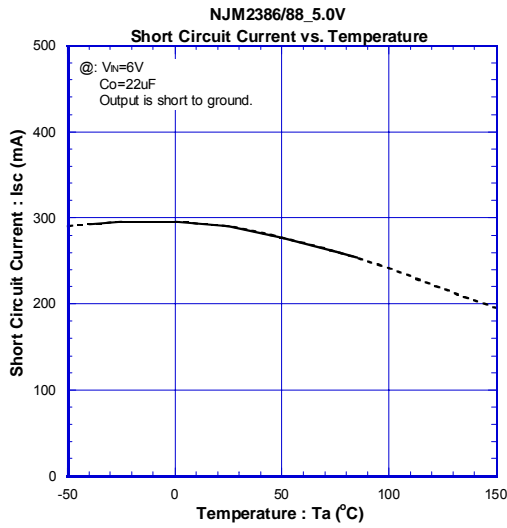
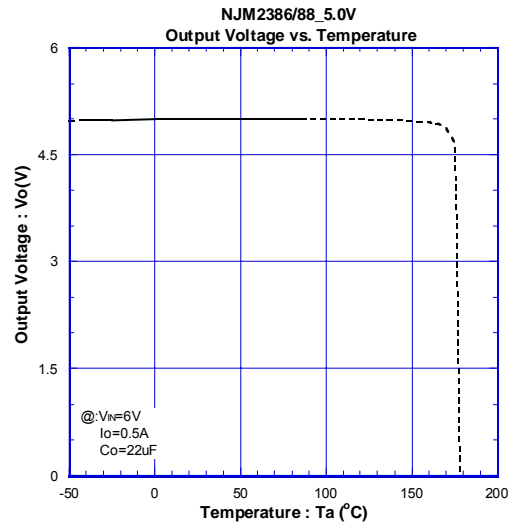
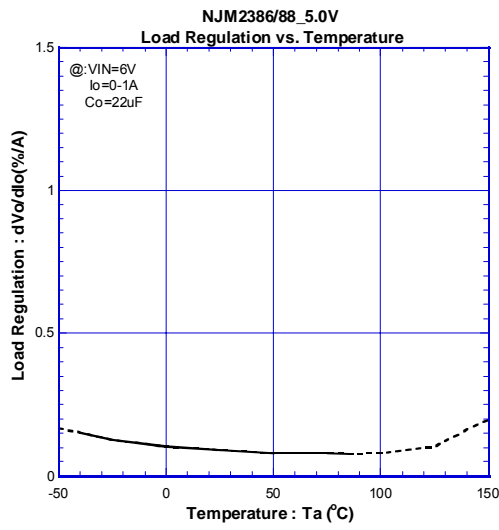



## TYPICAL CHARACTERISTICS

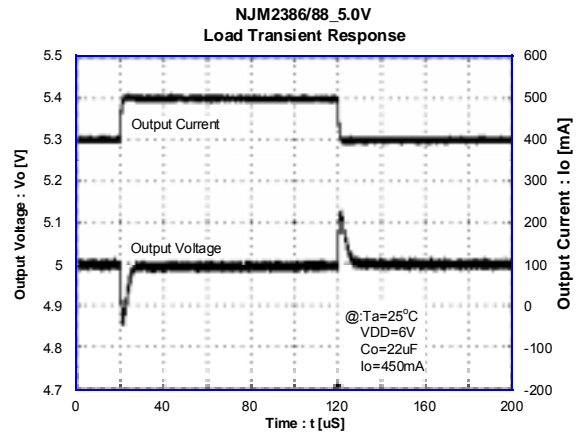
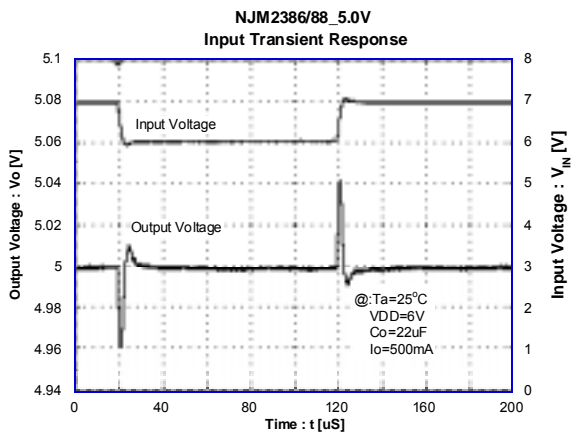

**[CAUTION]**

The specifications on this databook are only given for information, without any guarantee as regards either mistakes or omissions. The application circuits in this databook are described only to show representative usages of the product and not intended for the guarantee or permission of any right including the industrial rights.