

ABSOLUTE MAXIMUM RATINGS

(Note 1)

| | |
|---|----------------|
| V _{CC} Voltage | 16V |
| SW1, SW2, SW3 Voltage | -0.4V to 36V |
| SW4 | -0.4V to 45V |
| FB1, FB3 Voltage | 2.5V |
| FB4 Voltage | 400mV |
| NFB2 Voltage | -200mV |
| SHDN Voltage | 10V |
| CTRL4 Voltage | 16V |
| SS1, SS4 Voltage | 1.5V |
| Current Into D2 | 1A |
| D2 Voltage | -36V |
| Current Out of D3 | 1A |
| D3 Voltage | 36V |
| Current Out of D4 | 4A |
| D4 Voltage | 45V |
| LED1, LED2 Voltage | 45V |
| Current Into LED1, LED2 | 35mA |
| PGOOD Voltage | 16V |
| V _{OUT3} Voltage | 36V |
| CT Current | ±1mA |
| Maximum Junction Temperature | 125°C |
| Operating Temperature Range (Note 2) .. | -40°C to 85°C |
| Storage Temperature Range | -65°C to 125°C |

PACKAGE/ORDER INFORMATION

| | |
|--|-------------------|
| <p>TOP VIEW</p> <p>UF PACKAGE 24-LEAD (4mm × 4mm) PLASTIC QFN T_{JMAX} = 125°C, θ_{JA} = 37°C/W, θ_{JC} = 4.3°C/W EXPOSED PAD (PIN 25) IS SGND (MUST BE SOLDERED TO PCB)</p> | ORDER PART NUMBER |
| | LT1942EUF |
| | UF PART MARKING |
| | 1942 |
| <p>Order Options Tape and Reel: Add #TR Lead Free: Add #PBF Lead Free Tape and Reel: Add #TRPBF Lead Free Part Marking: http://www.linear.com/leadfree/</p> | |

Consult LTC Marketing for parts specified with wider operating temperature ranges.

ELECTRICAL CHARACTERISTICS The ● denotes the specifications which apply over the full operating temperature range, otherwise specifications are at T_A = 25°C. V_{IN} = 3.3V, V_{SHDN} = V_{IN}, unless otherwise noted. (Note 2)

| PARAMETER | CONDITIONS | MIN | TYP | MAX | UNITS | |
|---|--|-----|-------|------|-------|----|
| Quiescent Current | V _{SHDN} = 3.3V, V _{CTRL4} = 0V, Not Switching | ● | 7 | 10 | mA | |
| | V _{SHDN} = V _{CTRL4} = 0V, In Shutdown | ● | 0 | 1 | | |
| Input Voltage Range | V _{CC} Pin | ● | 2.6 | 16 | V | |
| AV _{DD} Feedback Voltage | FB1 Pin | ● | 1.225 | 1.25 | 1.275 | V |
| AV _{DD} Feedback Pin Bias Current (FB1) | FB1 Pin (Note 3) | | 15 | 60 | nA | |
| AV _{DD} Feedback Voltage for Power Good Signal | FB1 Pin Voltage as a Percent of Nominal Voltage | ● | 95 | 97 | 100 | % |
| V _{OFF} Feedback Voltage | NFB2 Pin | | -160 | -150 | -140 | mV |
| V _{OFF} Feedback Pin Bias Current (NFB2) | NFB2 Pin (Note 3) | | 25 | 60 | nA | |
| V _{ON} Feedback Voltage | FB3 Pin | | 1.225 | 1.25 | 1.275 | V |
| V _{ON} Feedback Pin Bias Current (FB3) | FB3 Pin (Note 3) | | 25 | 60 | nA | |
| LED Feedback Voltage | FB4 Pin, V _{CTRL4} = 3.3V | ● | 190 | 200 | 210 | mV |
| LED Feedback Pin Bias Current (FB4) | FB4 Pin (Note 3) | | 20 | 60 | μA | |
| LED Feedback Voltage with Dimming | FB4 Pin, V _{CTRL4} = 1V | | 85 | 95 | 105 | mV |

ELECTRICAL CHARACTERISTICS

The ● denotes the specifications which apply over the full operating temperature range, otherwise specifications are at $T_A = 25^\circ\text{C}$. $V_{IN} = 3.3\text{V}$, $V_{\overline{\text{SHDN}}} = V_{IN}$, unless otherwise noted. (Note 2)

| PARAMETER | CONDITIONS | MIN | TYP | MAX | UNITS |
|--|---|------|------|------|---------------|
| LED1-LED2 Current Matching | Current Into Each Pin = 20mA, $V_{\text{LED1}} = V_{\text{LED2}}$ | | 0 | 1.5 | % |
| | Current Into Each Pin = 20mA, $ V_{\text{LED1}} - V_{\text{LED2}} = 1\text{V}$ | | 1 | 2.5 | % |
| LED1 Voltage | 20mA Into Pin, $V_{\text{LED2}} = 2\text{V}$, $\text{FB4} = 0$ | | 1 | 1.2 | V |
| LED2 Voltage | 20mA Into Pin, $V_{\text{LED1}} = 2\text{V}$, $\text{FB4} = 0$ | | 1 | 1.2 | V |
| LED1, LED2 Maximum Current | Into Either Pin, $V_{\text{LEDX}} < 1.5\text{V}$, $\text{FB4} = 0$ | 35 | | | mA |
| LED1, LED2 Leakage Current | $V_{\overline{\text{SHDN}}} = 0\text{V}$, $V_{\text{LEDX}} = 45\text{V}$ | ● | | 1 | μA |
| AV_{DD} Maximum Duty Cycle | SW1 Pin | 88 | 93 | | % |
| V_{OFF} Maximum Duty Cycle | SW2 Pin | 75 | 86 | | % |
| V_{ON} Maximum Duty Cycle | SW3 Pin | 75 | 86 | | % |
| LED Maximum Duty Cycle | SW4 Pin | 88 | 93 | | % |
| AV_{DD} Switch Current Limit at Minimum DC (SW1) | SW1 Pin (Note 4) | 150 | 200 | 250 | mA |
| AV_{DD} Switch Current Limit at Maximum DC (SW1) | SW1 Pin (Note 4) | 80 | 140 | 200 | mA |
| V_{OFF} Switch Current Limit at Minimum DC (SW2) | SW2 Pin (Note 4) | 50 | 80 | 110 | mA |
| V_{OFF} Switch Current Limit at Maximum DC (SW2) | SW2 Pin (Note 4) | 30 | 60 | 90 | mA |
| V_{ON} Switch Current Limit at Minimum DC (SW3) | SW3 Pin (Note 4) | 50 | 80 | 110 | mA |
| V_{ON} Switch Current Limit at Maximum DC (SW3) | SW3 Pin (Note 4) | 30 | 60 | 90 | mA |
| LED Switch Current Limit at Minimum DC (SW4) | SW4 Pin (Note 4) | 550 | 750 | 900 | mA |
| LED Switch Current Limit at Maximum DC (SW4) | SW4 Pin (Note 4) | 450 | 600 | 850 | mA |
| V_{OFF} Schottky Diode Forward Drop | D2 Pin, $I = 60\text{mA}$ | | 0.65 | | V |
| V_{OFF} Schottky Diode Leakage Current | D2 Pin, $V_{\text{D2}} = -36\text{V}$ | ● | | 1 | μA |
| V_{ON} Schottky Diode Forward Drop | D3 Pin, $I = 60\text{mA}$ | | 0.65 | | V |
| V_{ON} Schottky Diode Leakage Current | $V_{\text{D3}} = 36\text{V}$, $\text{SW3} = 0\text{V}$, Output Disconnect PNP Off | ● | | 1 | μA |
| LED Schottky Diode Forward Drop | $I = 250\text{mA}$ | | 0.75 | | V |
| LED Schottky Diode Leakage Current | $V_{\text{D4}} = 36\text{V}$, $\text{SW4} = 0\text{V}$ | ● | | 1 | μA |
| Switching Frequency | | 0.8 | 1 | 1.2 | MHz |
| $\overline{\text{SHDN}}$ Pin Current | $V_{\overline{\text{SHDN}}} = 3\text{V}$ | ● | 70 | 100 | μA |
| | $V_{\overline{\text{SHDN}}} = 0\text{V}$ | | 20 | 30 | nA |
| CTRL4 Pin Current | $V_{\text{CTRL4}} = 3\text{V}$ | ● | 30 | 60 | μA |
| | $V_{\text{CTRL4}} = 0\text{V}$ | | -60 | -150 | nA |
| SW1-SW4 leakage Current | $V_{\text{SWX}} = 36\text{V}$ | ● | 0.01 | 1 | μA |
| SW1 V_{CESAT} | $I_{\text{SW1}} = 100\text{mA}$ (Note 5) | | 200 | 300 | mV |
| SW2 V_{CESAT} | $I_{\text{SW2}} = 40\text{mA}$ (Note 5) | | 150 | 250 | mV |
| SW3 V_{CESAT} | $I_{\text{SW3}} = 40\text{mA}$ (Note 5) | | 150 | 250 | mV |
| SW4 V_{CESAT} | $I_{\text{SW4}} = 400\text{mA}$ (Note 5) | | 280 | 400 | mV |
| SS1 Charging Current | $V_{\text{SS}} = 0.5\text{V}$ | 1 | 3 | 5 | μA |
| SS4 Charging Current | $V_{\text{SS}} = 0.5\text{V}$ | 1 | 3 | 5 | μA |
| $\overline{\text{SHDN}}$ Input Voltage High | | 1 | | | V |
| $\overline{\text{SHDN}}$ Input Voltage Low | | | | 0.4 | V |
| CTRL4 Input Voltage High | | 0.25 | | | V |
| CTRL4 Input Voltage Low | | | | 0.1 | V |

ELECTRICAL CHARACTERISTICS

The ● denotes the specifications which apply over the full operating temperature range, otherwise specifications are at $T_A = 25^\circ\text{C}$. $V_{IN} = 3.3\text{V}$, $V_{SHDN} = V_{IN}$, unless otherwise noted. (Note 2)

| PARAMETER | CONDITIONS | MIN | TYP | MAX | UNITS |
|---|--|-----|-----|-----|---------------|
| PGOOD Leakage Current | PGOOD NPN Off, $V_{PGOOD} = 5\text{V}$ | | 0 | 0.1 | μA |
| PGOOD Sink Current | PGOOD NPN On, $V_{PGOOD} = 1\text{V}$ | 0.5 | 0.7 | | mA |
| CT Charging Current | | | 12 | | μA |
| CT Reference Voltage | | | 0.8 | | V |
| V_{OUT3} Leakage Current | Output Disconnect PNP Off, $D3 = 36\text{V}$, $V_{OUT} = 0\text{V}$ | | 0 | 1 | μA |
| V_{OUT3} Source Current | Output Disconnect PNP On, $D3 = 3\text{V}$, $V_{OUT} = 2.5\text{V}$ | 10 | 15 | | mA |
| Minimum $D3/V_{OUT3}$ Operating Voltage | Minimum $D3$ Voltage for Proper Output Disconnect PNP Operation | | 3 | | V |
| D4 LED Open-Circuit Voltage | | 38 | 42 | 44 | V |

Note 1: Stresses beyond those listed under Absolute Maximum Ratings may cause permanent damage to the device. Exposure to any Absolute Maximum Rating condition for extended periods may affect device reliability and lifetime.

Note 2: The LT1942 is guaranteed to meet performance specifications from 0°C to 70°C . Specifications over the -40°C to 85°C operating

temperature range are assured by design, characterization and correlation with statistical controls.

Note 3: Current flows out of the pin.

Note 4: Current limit guaranteed by design and/or correlation to static test.

Note 5: V_{CESAT} 100% tested at wafer level.

TYPICAL PERFORMANCE CHARACTERISTICS

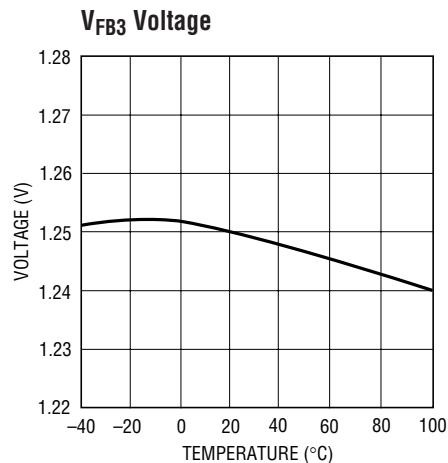
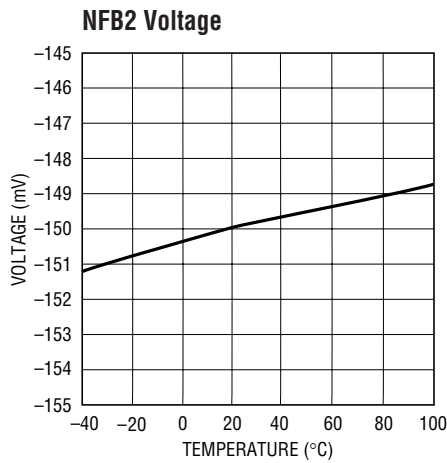
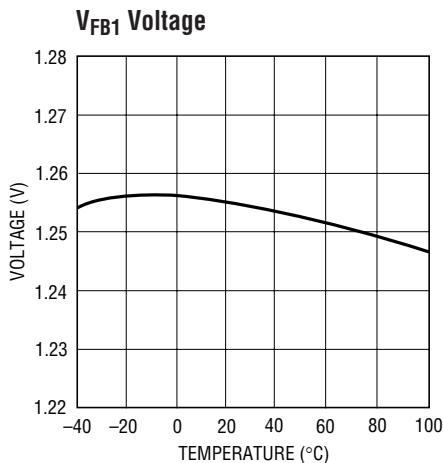

TYPICAL PERFORMANCE CHARACTERISTICS

FB4 Voltage

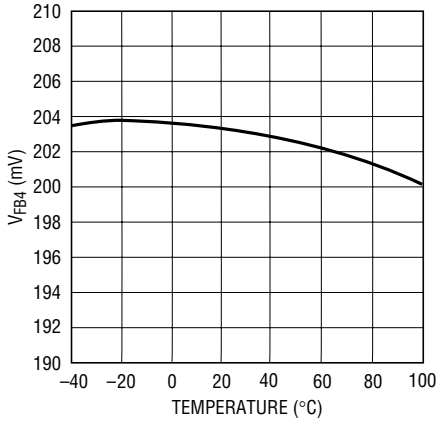

1942 G04

V_{FB4} vs CTRL4

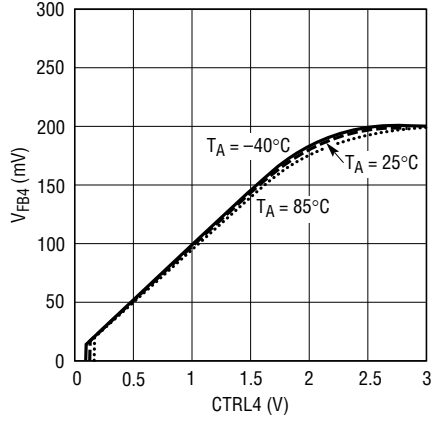

1942 G05

Oscillator Frequency

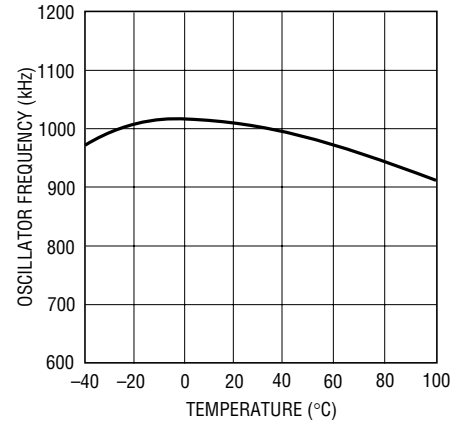

1942 G06

Quiescent Current

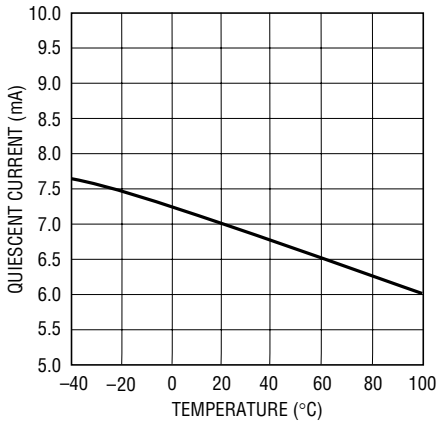

1942 G07

CT Timer Delay Time

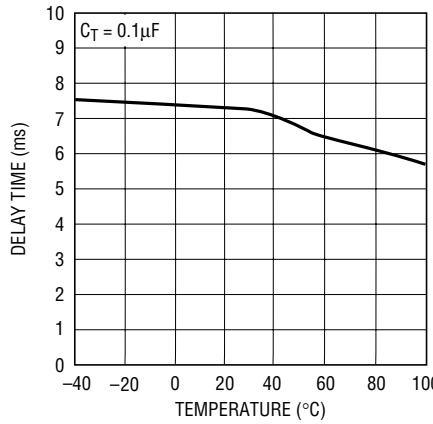

1942 G08

SW1 Saturation Voltage

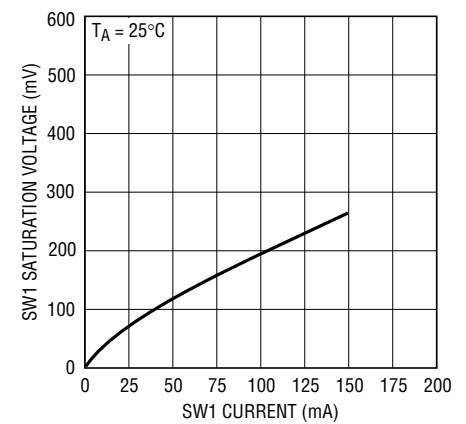

1942 G09

SW2 Saturation Voltage

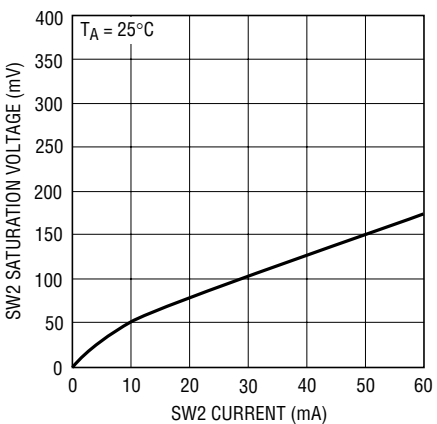

1942 G10

SW3 Saturation Voltage

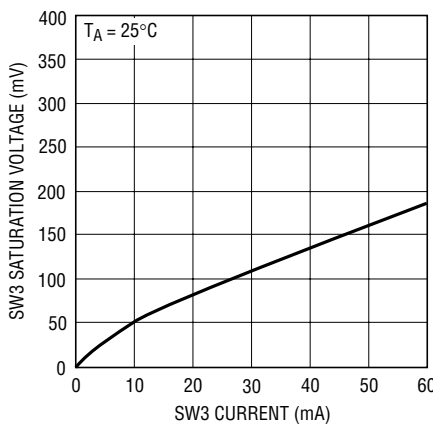

1942 G10

SW4 Saturation Voltage

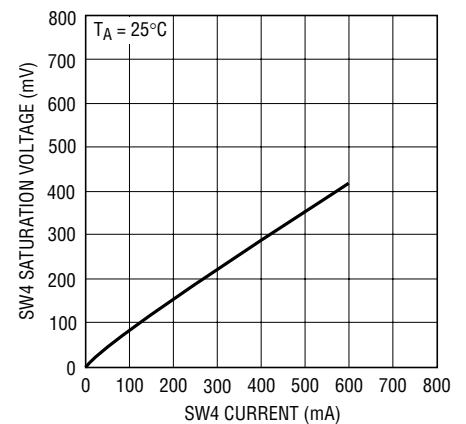

1942 G12

TYPICAL PERFORMANCE CHARACTERISTICS

LED1 to LED2 Current Matching

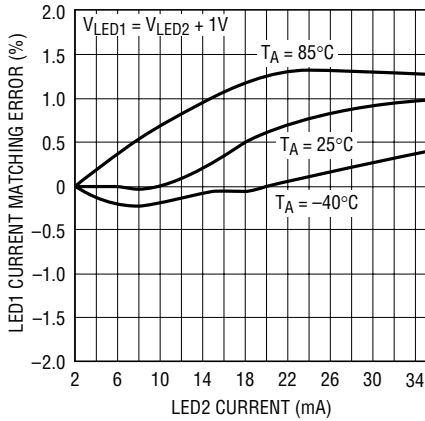

1942 G13

V_{OUT3} vs I_{OUT3}

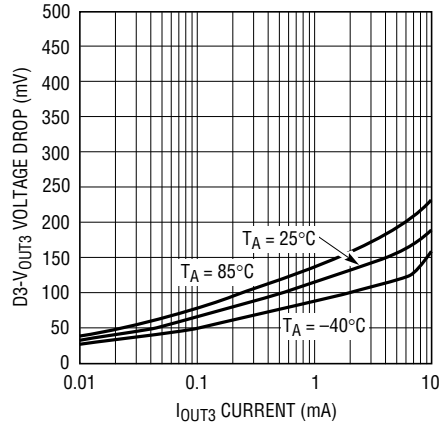

1942 G14

LED Open-Circuit Protection Voltage

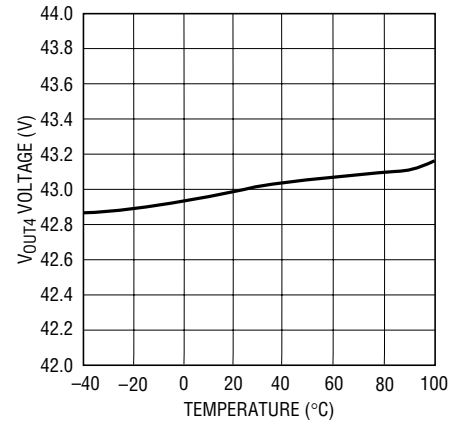

1942 G08

D4 Forward Voltage

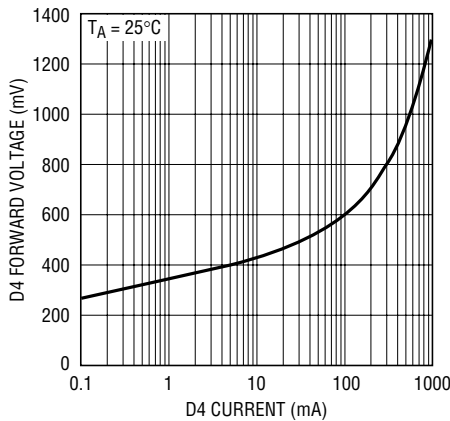

1942 G16

V_{OFF} Diode Forward Voltage

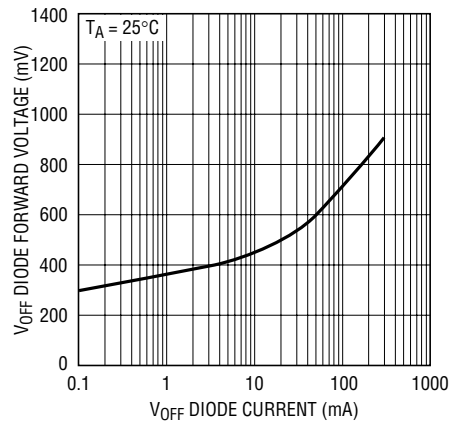

1942 G17

V_{ON} Diode Forward Voltage

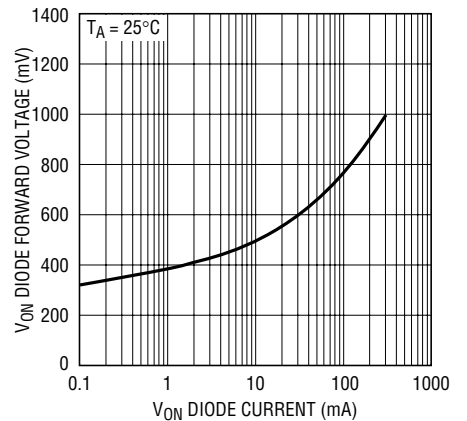

1942 G19

AV_{DD} Switcher Current Limit

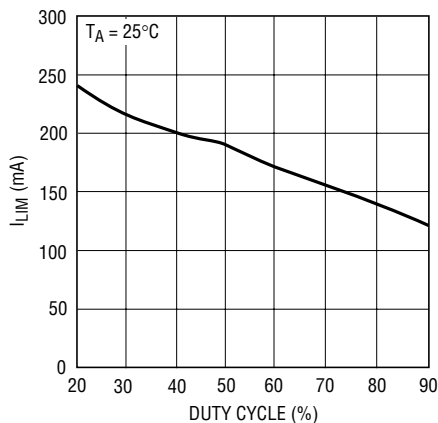

1942 G18

LED Switcher Current Limit

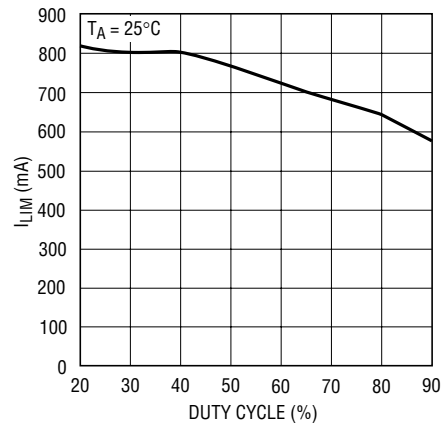

1942 G20

PIN FUNCTIONS

PGND23 (Pin 1): Power Ground for V_{OFF} and V_{ON} Switcher. Tie directly to local ground plane.

SW3 (Pin 2): Switch Pin for V_{ON} Switcher. This is the collector of an internal NPN power switch. Minimize the metal trace area connected to this pin to minimize EMI.

D3 (Pin 3): Output of V_{ON} Switcher. Place output decoupling capacitor from this pin to local ground plane.

V_{OUT3} (Pin 4): Collector of Internal Output Disconnect PNP Transistor for the V_{ON} Switcher. Place a capacitor from this pin to local ground plane of at least $0.1\mu\text{F}$.

FB3 (Pin 5): Feedback Pin for V_{ON} Switcher. Reference voltage is 1.25V . Connect resistive divider tap here. Minimize trace area at FB3. Set V_{OUT3} according to $V_{OUT3} = 1.25(1 + R5/R6)$.

NFB2 (Pin 6): Feedback Pin for V_{OFF} Switcher. Reference voltage is -150mV . Connect resistive divider tap here. Minimize trace area at NFB2. Set V_{OUT2} according to $V_{OUT2} = (-0.15)(1 + R3/R4)$.

SHDN (Pin 7): Shutdown. Tie to 1V or greater to enable the part. Tie to 0.4V or lower to disable. This pin is the global shutdown pin for all four switching regulators.

CTRL4 (Pin 8): Shutdown for the LED Switcher. Tie to 0.25V or greater to enable the LED switcher. Tie to 0.1V or lower to disable. CTRL4 can also override the default 200mV reference for the LED switcher. If CTRL4 is tied to 2.5V or greater, the reference voltage is 200mV . If CTRL4 is less than 2.5V , the LED reference voltage is approximately $V_{CTRL4}/10$. This allows an 8:1 dimming range for the LEDs. Refer to the Applications Section for more information.

CT (Pin 9): Programmable Delay for the TFT Supplies. Place a capacitor from this pin to local ground plane. After the delay, the output disconnect PNP for the V_{ON} supply is turned on. The delay time is initiated when AV_{DD} reaches 97% of its final value.

AGND (Pin 10): Analog Ground. Tie directly to local ground plane.

SS1 (Pin 11): Soft-Start Pin for AV_{DD} Switcher. Place a soft-start capacitor from this pin to ground. Upon start-up, $3\mu\text{A}$ of current charges the capacitor to 1.25V . Use larger capacitor for slower start-up. Leave floating if not in use.

SS4 (Pin 12): Soft-Start for LED Switcher. Place a soft-start capacitor from this pin to ground. Upon start-up, $3\mu\text{A}$ of current charges the capacitor to 1.25V . Use larger capacitor for slower start-up. Leave floating if not in use.

PGOOD (Pin 13): Power Good Indication for AV_{DD} Switcher. Open-collector NPN. Stays open until the V_{FB1} voltage reaches 97% of target value at which point the pin will pull down.

FB1 (Pin 14): Feedback Pin for AV_{DD} Switcher. Connect resistive divider tap here. Minimize trace area at FB1. Set V_{OUT1} according to $V_{OUT1} = 1.25(1 + R1/R2)$.

FB4 (Pin 15): Feedback Pin for LED Switcher. Place a resistor from this node to ground. Choose $R7$ to set LED current (I_{LED}) according to the following formula:

$$\text{if } V_{CTRL4} \geq 2.5\text{V}, R7 = 0.2/I_{LED}$$

In this case, I_{LED} is the total LED current. If two strings of LEDs are used, I_{LED} is the sum of the current in the two strings. If only a single string of LEDs is used, I_{LED} is simply the single string current. For dimming LED current, drive V_{CTRL4} to a lower voltage. See the Applications Section for more information.

D4 (Pin 16): Output of LED Switcher. Place output decoupling capacitor from this pin to local ground plane.

LED2 (Pin 17): Second Input of Current Mirror for an LED String. Connect the negative end of second string of LEDs to this pin. If not in use, leave floating.

PIN FUNCTIONS

LED1 (Pin 18): First Input of Current Mirror for an LED String. Connect the negative end of first string of LEDs to this pin. If not in use, leave floating.

SW4 (Pin 19): Switch Pin for LED Switcher. This is the collector of an internal NPN power switch. Minimize the metal trace area connected to this pin to minimize EMI.

SW1 (Pin 20): Switch Pin for AV_{DD} Switcher. This is the collector of an internal NPN Power switch. Minimize the metal trace area connected to this pin to minimize EMI.

PGND14 (Pin 21): Power Ground for LED Switcher and AV_{DD} Switcher. Tie directly to local ground plane.

V_{CC} (Pin 22): Input Supply. Must be locally bypassed.

D2 (Pin 23): Anode Connection of Internal Schottky Diode for V_{OFF} Switcher.

SW2 (Pin 24): Switch Pin for V_{OFF} Switcher. This is the collector of an internal NPN Power switch. Minimize the metal trace area connected to this pin to minimize EMI.

SGND (Pin 25): Signal Ground. This is the Exposed Pad, which must be soldered directly to a local ground plane to achieve optimum thermal performance.

BLOCK DIAGRAM

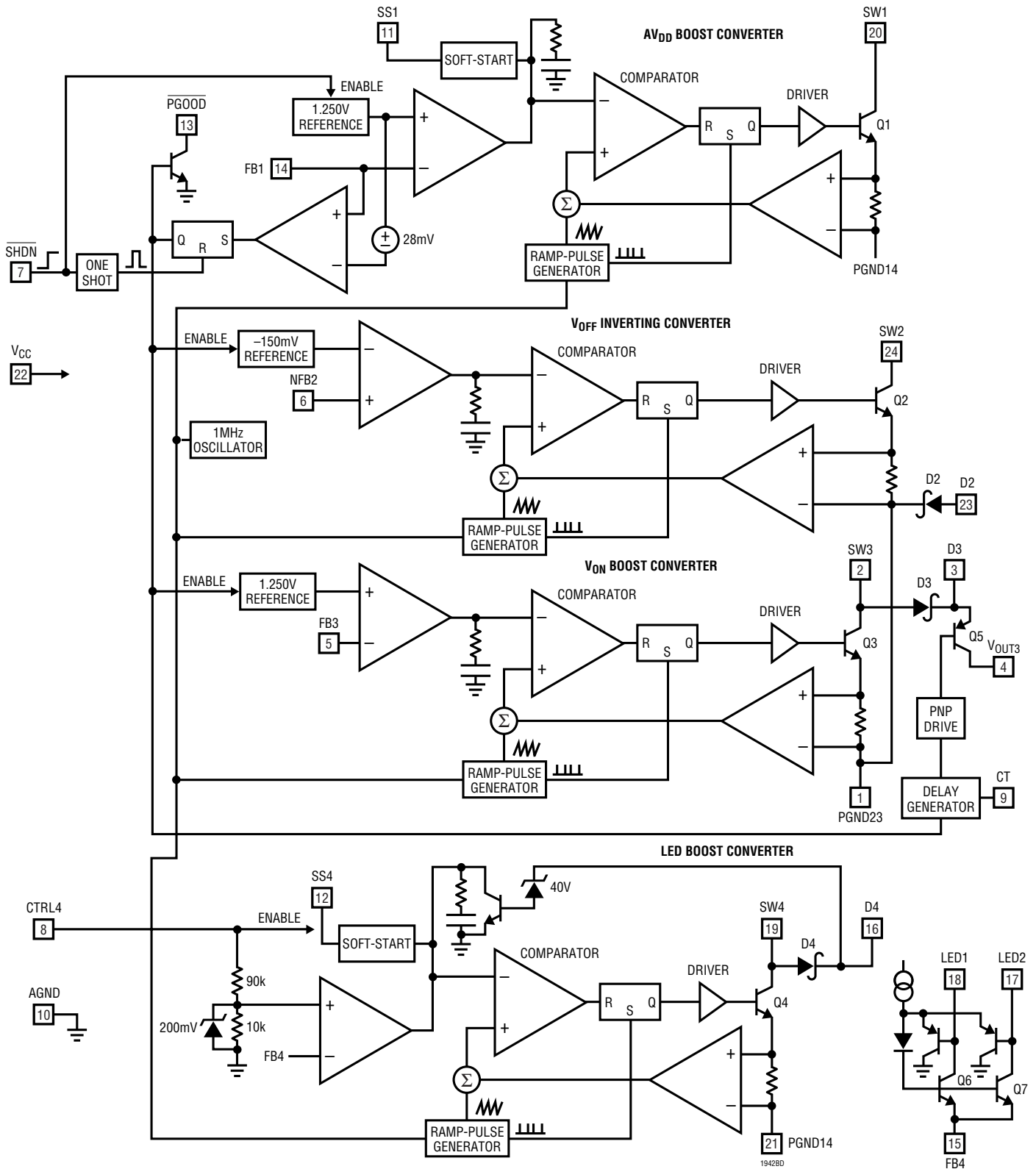

OPERATION

Refer to the figure on the first page of this data sheet and the Block Diagram when following the description of the operation of the LT1942. The LT1942 contains four switching regulators. Three switchers are designed to be used as the power supply for driving small to medium sized TFT displays. The fourth switcher is designed to power an LED backlight. All four switching regulators use a constant frequency, current mode control scheme to provide excellent line and load regulation.

TFT Supply

The three switching regulators for the TFT supply are named AV_{DD} , V_{OFF} and V_{ON} . Both the AV_{DD} and V_{ON} switchers are boost type, while the V_{OFF} is an inverting type. Power sequencing circuitry is integrated into the LT1942 to properly power up the TFT power supply. When the SHDN pin is driven above 1V initially, only the AV_{DD} switcher is enabled. After the output of the AV_{DD} switcher reaches 97% of its final value, the PGOOD pin is driven low and both the V_{OFF} and V_{ON} switchers are enabled. This event is latched rejecting any later drops on AV_{DD} below 97%. The output-disconnect circuitry (Q5 in the Block Diagram) for the V_{ON} switcher is not activated until the programmable delay set by the CT pin has elapsed. Once the output-disconnect circuitry is enabled, the V_{OUT3} pin is driven to nearly the same voltage as D3. The V_{OUT3} pin can only source current and is limited to 15mA nominally. All three switching regulators are internally compensated and operated at a fixed frequency of 1MHz. The AV_{DD} switching regulator has integrated soft-start. Simply place a capacitor from the SS1 pin to GND to implement soft-start.

LED Supply

The fourth switching regulator in the LT1942 is designed to drive up to 20 LEDs (2 strings of 10) to power a backlight. The LED switcher has an integrated current ballaster (Q6 and Q7 in the Block Diagram) which enables two strings of LEDs to have active current matching. The current into LED1 and LED2 will always be actively matched, regardless of which LED string has the highest voltage drop. The LED ballast circuitry can be left unused when driving a single string of LEDs. Simply leave the LED1 and LED2 inputs floating and return the LED string directly to the FB4 pin. The LED switcher has an independent control pin which serves two functions: shutdown and reference adjustment. The CTRL4 pin needs to be driven above 0.25V to enable the LED switcher. When CTRL4 is between 0.25V and 2.5V, the internal reference for the LED switcher is attenuated. If CTRL4 is above 2.5V, the internal reference is limited to 200mV no matter how high CTRL4 is. This feature allows an 8:1 dimming range for the LEDs. The LED switching regulator is internally compensated and operates at a fixed frequency of 1MHz. The LED switching regulator has LED open-circuit protection. If any LED fails open, D4 is not allowed to exceed 42V (typical). This prevents damage to the power switch. The LED switching regulator also has built in soft-start. By placing a capacitor from the SS4 pin to GND, the user can program the soft-start time.

APPLICATIONS INFORMATION

Setting the Output Voltages

Unlike charge-pump-based TFT supplies, the LT1942 TFT outputs can all be independently set. The AV_{DD} , V_{OFF} and V_{ON} outputs are all inductively based DC/DC converters. As such, the output voltages are set by choosing the right feedback divider ratio. The AV_{DD} feedback pin is FB1 and the reference voltage is 1.25V. The V_{OFF} feedback pin is NFB2 and the reference voltage is -150mV . The V_{ON} feedback pin is FB3 and the reference voltage is 1.25V. The LED driver is also an inductively based DC/DC converter.

Output Disconnect

The V_{ON} switching regulator has built in output disconnect. When the V_{ON} supply is enabled, the boost converter will charge up the D3 node. With the output disconnect PNP (Q5) turned off, the voltage on V_{OUT3} will be zero. Once the power sequencing circuitry turns on the PNP, V_{OUT3} will go to nearly the same voltage as D3.

The V_{OFF} switching regulator naturally achieves output disconnect due to the switching topology (inverting configuration). When the LT1942 is in shutdown, V_{OFF} will go to zero volts.

The AV_{DD} switching regulator provides a $\overline{\text{PGOOD}}$ pin to be used for an external output disconnect function. This pin can drive the gate of a PMOS device. When the LT1942 is first enabled, the AV_{DD} switching regulator begins to charge up the output capacitor. Since $\overline{\text{PGOOD}}$ is still an open collector at this point, the PMOS device is turned off, leaving the AV_{DD} output at zero volts. Once the output capacitor charges to 97% of the final value, $\overline{\text{PGOOD}}$

latches low turning on the PMOS device and bringing the AV_{DD} output quickly to the desired voltage.

Soft-Start

The higher current regulators, AV_{DD} and LED, have user programmable soft-start functions built into the part. Simply place a capacitor from the SS1 pin to GND to achieve soft-start for the AV_{DD} switcher. For the LED switcher, place a capacitor from the SS4 pin to GND. A good value for both soft-start capacitors is $0.1\mu\text{F}$. The soft-start time is dependent on the load characteristics which will vary depending on the type and size of the TFT display. It is a good practice to experiment to determine the best value for the soft-start capacitors.

Power Sequencing

The TFT supply has integrated supply sequencing built-in to ensure proper initiation of the TFT display. Figure 1 shows a state diagram of the power sequencing circuitry. The power sequencing circuitry insures that the AV_{DD} supply comes up first, then the negative V_{OFF} supply and lastly the V_{ON} positive supply. To pick the CT capacitor for a particular delay, use the following equation:

$$C_T = \frac{10\mu\text{A} \cdot t_{\text{DELAY}}}{0.7\text{V}}$$

Figure 2 shows the power sequencing during start-up of the TFT power supply for the circuit shown in the figure on the first page of this data sheet. All bias supplies start up in a well controlled and well timed manner. The LED backlight driver is independently controlled via the CTRL4 pin.

APPLICATIONS INFORMATION

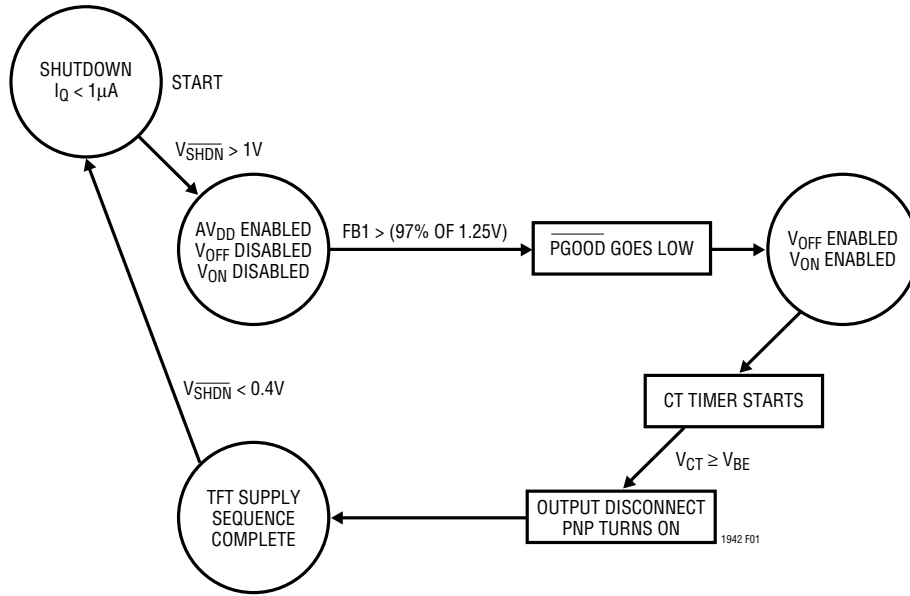

Figure 1. Power Sequencing State Diagram

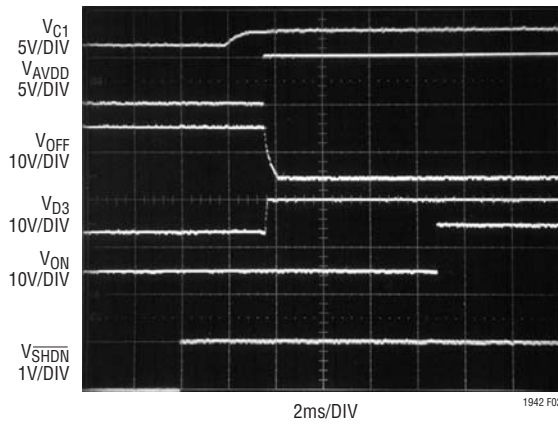

Figure 2. Power Sequencing During TFT Supply Start-Up (Refer to Figure 4 Node Names)

APPLICATIONS INFORMATION

Layout Hints

Proper layout techniques must be followed to achieve advertised performance of the part. Keep all SW and FB traces short and small. There are several power ground pins on the LT1942 and it is important to implement the grounding properly. PGND14 is the power ground pin for the AV_{DD} and LED switchers. The output capacitor for both the AV_{DD} and LED switcher must be returned back to this pin before being allowed to mix into the ground plane.

Similarly, PGND23 is the power ground pin for the V_{ON} and V_{OFF} switcher. Again, both output capacitors for the V_{ON} and V_{OFF} switchers need to return to the PGND23 pin before mixing with the ground plane. Place the input decoupling capacitor, which ties from the V_{CC} pin to GND, as close to the part as possible. Please refer to Figure 3 for a recommended layout of the power path components. The component names are those shown in the circuit of Figure 4.

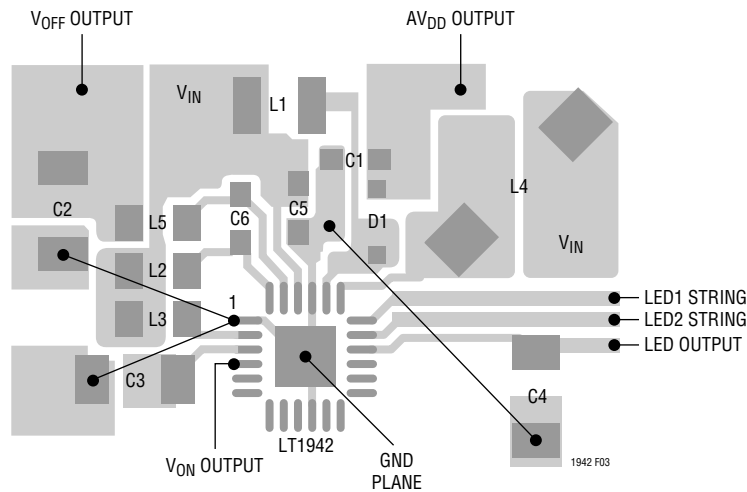

**Figure 3: Power Path Component Recommended Layout
(Refer to Figure 4 Component Names)**

TYPICAL APPLICATIONS

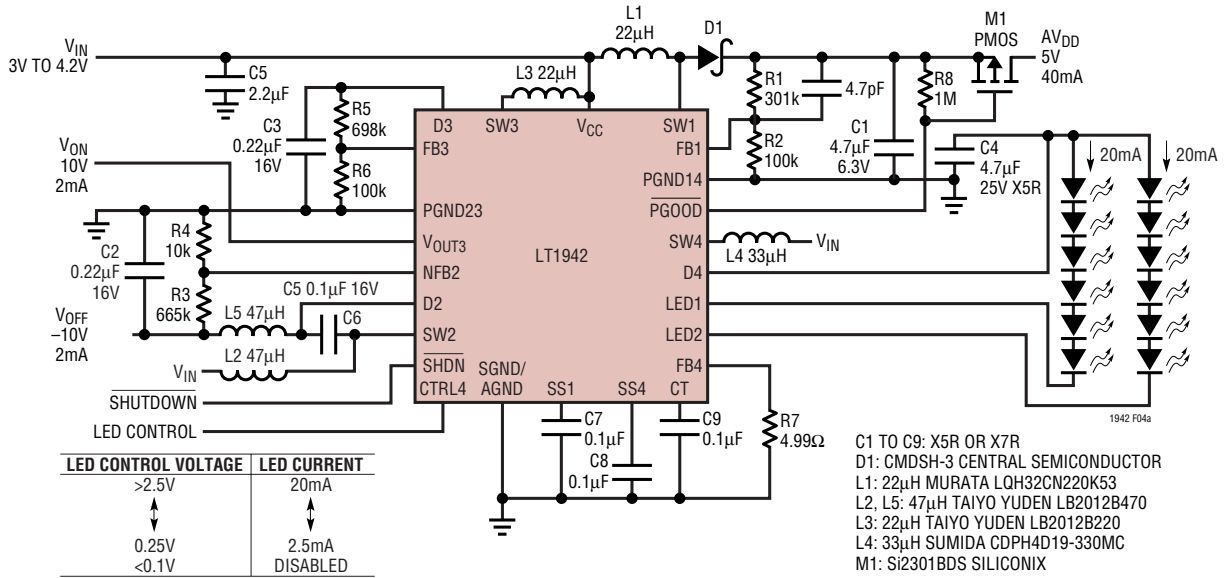
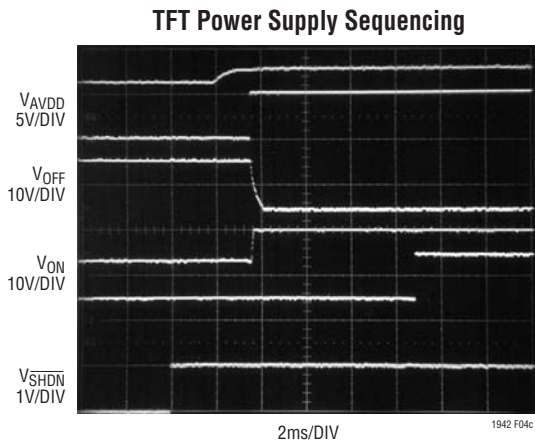
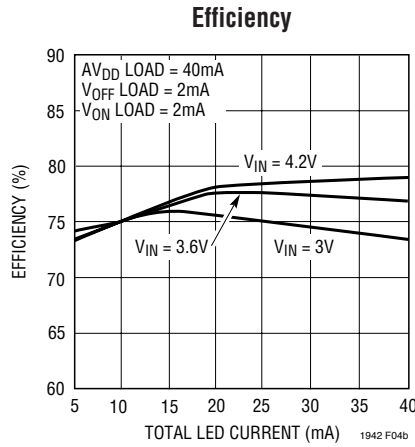
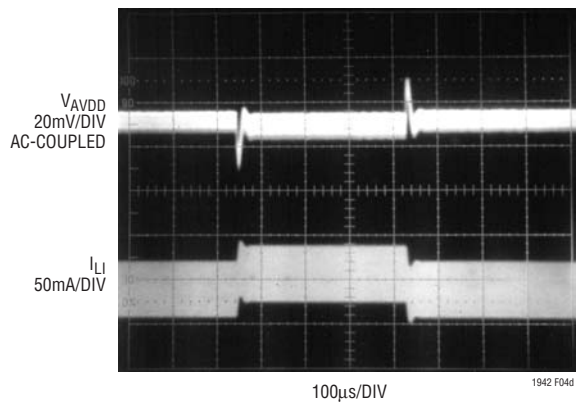

Figure 4. TFT Bias (5V, 10V, -10V) and White LED Backlight Supply from Single Li-Ion Cell



AV_{DD} Transient Response, I_{LOAD} Stepped from 30mA→40mA→30mA



PACKAGE DESCRIPTION

UF Package
24-Lead Plastic QFN (4mm × 4mm)
 (Reference LTC DWG # 05-08-1697)

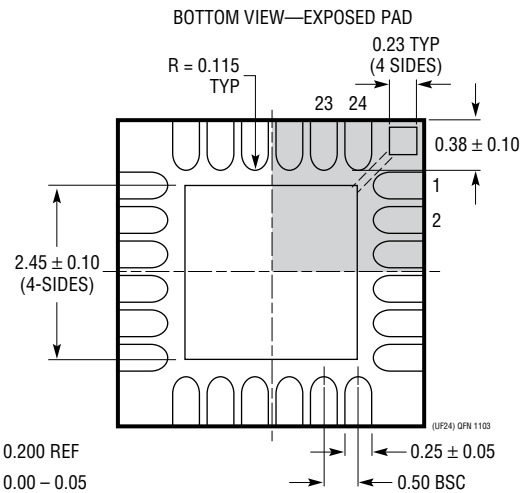
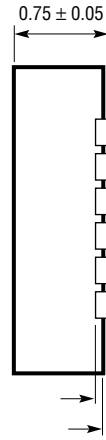
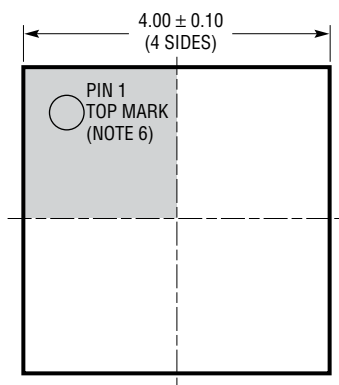
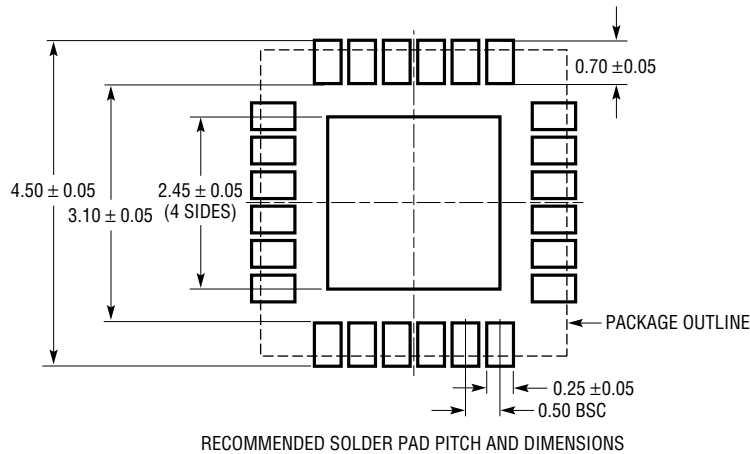

- NOTE:
1. DRAWING PROPOSED TO BE MADE A JEDEC PACKAGE OUTLINE MO-220 VARIATION (WGGD-X)—TO BE APPROVED
 2. DRAWING NOT TO SCALE
 3. ALL DIMENSIONS ARE IN MILLIMETERS
 4. DIMENSIONS OF EXPOSED PAD ON BOTTOM OF PACKAGE DO NOT INCLUDE MOLD FLASH. MOLD FLASH, IF PRESENT, SHALL NOT EXCEED 0.15mm ON ANY SIDE, IF PRESENT
 5. EXPOSED PAD SHALL BE SOLDER PLATED
 6. SHADED AREA IS ONLY A REFERENCE FOR PIN 1 LOCATION ON THE TOP AND BOTTOM OF PACKAGE

RELATED PARTS

| PART NUMBER | DESCRIPTION | COMMENTS |
|------------------------|---|--|
| LT1613 | 550mA (I_{SW}), 1.4MHz High Efficiency Step-Up DC/DC Converter | V_{IN} : 0.9V to 10V, $V_{OUT(MAX)}$ = 34V, I_Q = 3mA, I_{SD} < 1 μ A, ThinSOT Package |
| LT1615/LT1615-1 | 300mA/80mA (I_{SW}), Constant Off-Time, High Efficiency Step-Up DC/DC Converter | V_{IN} : 1.2V to 15V, $V_{OUT(MAX)}$ = 34V, I_Q = 20 μ A, I_{SD} < 1 μ A, ThinSOT Package |
| LT1930/LT1930A | 1A (I_{SW}), 1.2MHz/2.2MHz High Efficiency Step-Up DC/DC Converter | V_{IN} : 2.6V to 16V, $V_{OUT(MAX)}$ = 34V, I_Q = 4.2mA/5.5mA, I_{SD} < 1 μ A, ThinSOT Package |
| LT1932 | Constant Current, 1.2MHz, High Efficiency White LED Boost Regulator | V_{IN} : 1V to 10V, $V_{OUT(MAX)}$ = 34V, I_Q = 1.2mA, I_{SD} < 1 μ A, ThinSOT Package |
| LT1943 (Quad) | Quad Output, 2.6A Buck, 2.6A Boost, 0.3A Boost, 0.4A Inverter, 1.2MHz TFT DC/DC Converter | V_{IN} : 4.5V to 22V, $V_{OUT(MAX)}$ = 40V, I_Q = 10mA, I_{SD} < 35 μ A, TSSOP28E Package |
| LT1944/LT1944-1 (Dual) | Dual Output 350mA/100mA (I_{SW}), Constant Off-Time, High Efficiency Step-Up DC/DC Converter | V_{IN} : 1.2V to 15V, $V_{OUT(MAX)}$ = 34V, I_Q = 20 μ A, I_{SD} < 1 μ A, MS10 Package |
| LT1945 | Dual Output, Pos/Neg, 350mA (I_{SW}), Constant Off-Time, High Efficiency Step-Up DC/DC Converter | V_{IN} : 1.2V to 15V, $V_{OUT(MAX)}$ = \pm 34V, I_Q = 20 μ A, I_{SD} < 1 μ A, MS10 Package |
| LT1947 | Adjustable Output TFT-LCD Triple Switching Regulator | V_{IN} : 2.7V to 8V, $V_{OUT(MAX)}$ = 30V, I_Q = 9.5mA, I_{SD} < 1 μ A, MS10 Package |
| LTC3450 | Triple Output Power Supply for Small TFT-LCDs | V_{IN} : 1.5V to 4.6V, $V_{OUT(MAX)}$ = \pm 15V, I_Q = 75 μ A, I_{SD} < 1 μ A, DFN Package |
| LT3461/LT3461A | 0.3A (I_{SW}), 1.3MHz/3MHz, High Efficiency Step-Up DC/DC Converter with Integrated Schottky | V_{IN} : 2.5V to 16V, $V_{OUT(MAX)}$ = 38V, I_Q = 2.8mA, I_{SD} < 1 μ A, SC70, ThinSOT Packages |
| LT3464 | 0.08A (I_{SW}), High Efficiency Step-Up DC/DC Converter with Integrated Schottky, Output Disconnect | V_{IN} : 2.3V to 10V, $V_{OUT(MAX)}$ = 34V, I_Q = 25 μ A, I_{SD} < 1 μ A, ThinSOT Package |
| LT3465/LT3465A | Constant Current, 1.2MHz/2.7MHz High Efficiency White LED Boost Regulator with Integrated Schottky | V_{IN} : 2.7V to 16V, $V_{OUT(MAX)}$ = 34V, I_Q = 1.9mA, I_{SD} < 1 μ A, ThinSOT Package |
| LT3466 | Dual Constant Current, 2MHz, High Efficiency White LED Boost Regulator with Integrated Schottky | V_{IN} : 2.7V to 24V, $V_{OUT(MAX)}$ = 40V, I_Q = 5mA, I_{SD} < 16 μ A, DFN Package |
| LT3467/LT3467A | 1.1A (I_{SW}), 1.3MHz/2.1MHz, High Efficiency Step-Up DC/DC Converter with Integrated Soft-Start | V_{IN} : 2.4V to 16V, $V_{OUT(MAX)}$ = 40V, I_Q = 1.2mA, I_{SD} < 1 μ A, ThinSOT Package |