



ATTENTION
OBSERVE PRECAUTIONS
FOR HANDLING
ELECTROSTATIC
DISCHARGE
SENSITIVE
DEVICES

Part Number: APF3236LSEEZGKBKC

Hyper Red
Green
Blue

Features

- 3.2mmx3.6mm SMD LED, 1.1mm thickness.
- Low power consumption.
- One red, one green and one blue chips in one package.
- Package : 1000pcs / reel.
- Moisture sensitivity level : level 3.
- Low current IF=2mA operating.
- RoHS compliant.

Descriptions

- The Hyper Red source color devices are made with AlGaInP on GaAs substrate Light Emitting Diode.
- The Green source color devices are made with InGaN on Sapphire Light Emitting Diode.
- The Blue source color devices are made with InGaN on Sapphire Light Emitting Diode.
- Electrostatic discharge and power surge could damage the LEDs.
- It is recommended to use a wrist band or anti-electrostatic glove when handling the LEDs.
- All devices, equipments and machineries must be electrically grounded.

Package Dimensions

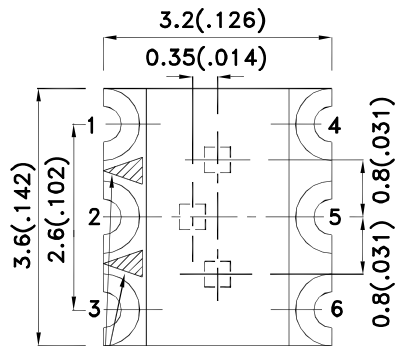

POLARITY MARK

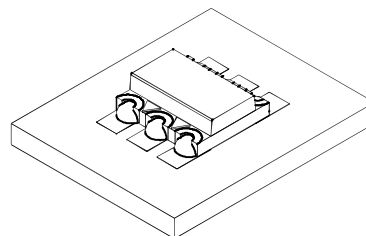
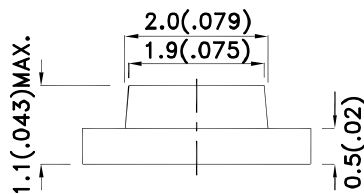
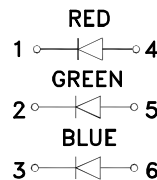

Notes:

1. All dimensions are in millimeters (inches).
2. Tolerance is $\pm 0.2(0.008)$ unless otherwise noted.
3. The specifications, characteristics and technical data described in the datasheet are subject to change without prior notice.
4. The device has a single mounting surface. The device must be mounted according to the specifications.



Selection Guide

Part No.	Emitting Color (Material)	Lens Type	Iv (mcd) [2] @ 2mA		Viewing Angle [1]
			Min.	Typ.	2θ1/2
APF3236LSEEZGKBKC	Hyper Red (AlGaInP)	Water Clear	6	15	120°
	Green (InGaN)		20	60	
	Blue (InGaN)		4	10	

Notes:

- θ1/2 is the angle from optical centerline where the luminous intensity is 1/2 of the optical peak value.
- Luminous intensity / luminous Flux: +/-15%.
- Luminous intensity value is traceable to the CIE127-2007 compliant national standards.

Electrical / Optical Characteristics at TA=25°C

Symbol	Parameter	Emitting Color	Typ.	Max.	Units	Test Conditions
λpeak	Peak Wavelength	Hyper Red Green Blue	630 515 460		nm	If=2mA
λD [1]	Dominant Wavelength	Hyper Red Green Blue	621 525 465		nm	If=2mA
Δλ1/2	Spectral Line Half-width	Hyper Red Green Blue	20 35 25		nm	If=2mA
C	Capacitance	Hyper Red Green Blue	25 45 100		pF	Vf=0V;f=1MHz
Vf [2]	Forward Voltage	Hyper Red Green Blue	1.8 2.65 2.65	2.1 3.1 3.1	V	If=2mA
Ir	Reverse Current	Hyper Red Green Blue		10 50 50	μA	VR=5V

Notes:

- Wavelength: +/-1nm.
- Forward Voltage: +/-0.1V.
- Wavelength value is traceable to the CIE127-2007 compliant national standards.
- Excess driving current and / or operating temperature higher than recommended conditions may result in severe light degradation or premature failure.

Absolute Maximum Ratings at TA=25°C

Parameter	Hyper Red	Green	Blue	Units
Power dissipation	63	77.5	93	mW
DC Forward Current	30	25	30	mA
Peak Forward Current [1]	195	150	150	mA
Electrostatic Discharge Threshold (HBM)	3000	450	250	V
Reverse Voltage	5			V
Operating Temperature	-40°C To +85°C			
Storage Temperature	-40°C To +85°C			

Notes:

- 1/10 Duty Cycle, 0.1ms Pulse Width.

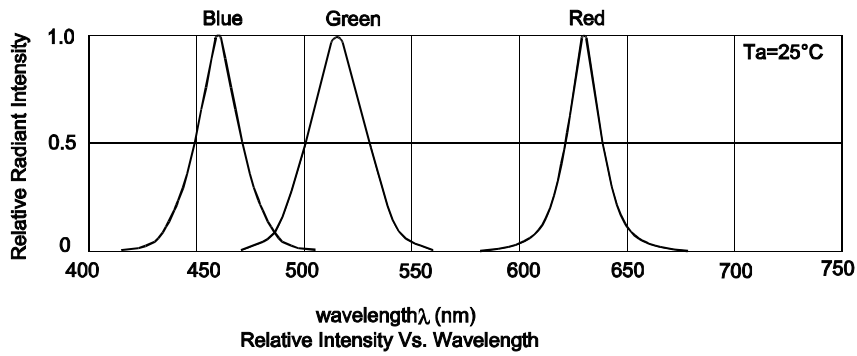

APF3236LSEEZGKBKC
Hyper Red

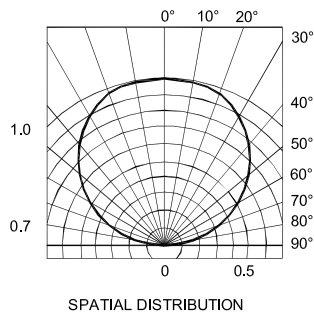
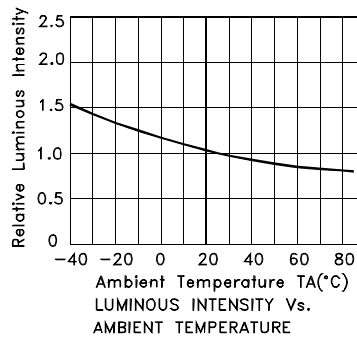
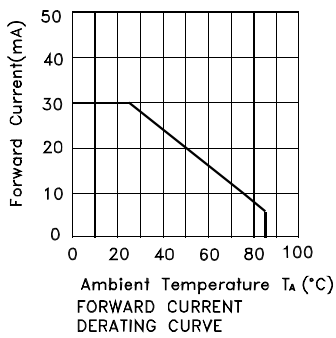
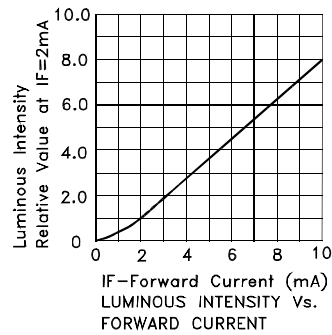
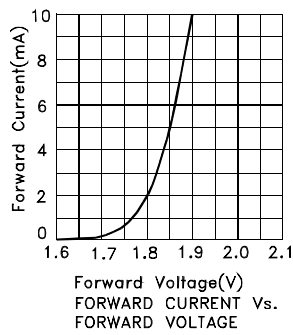

Green

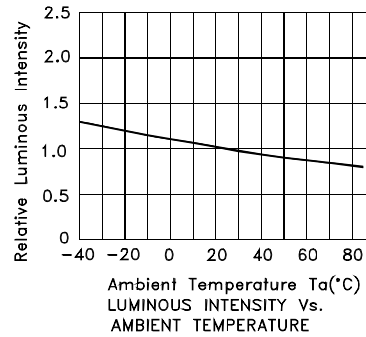
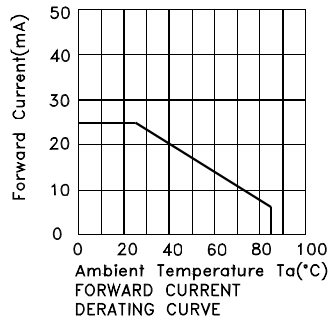
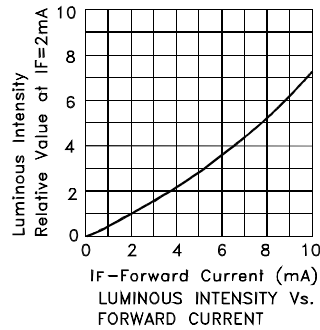
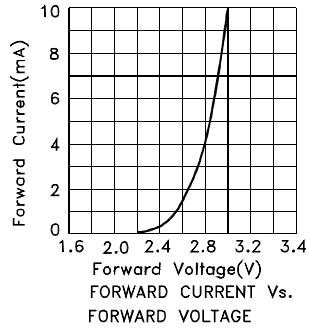

Kingbright

Blue

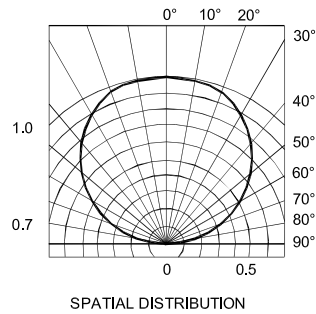
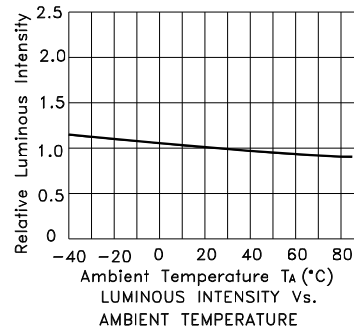
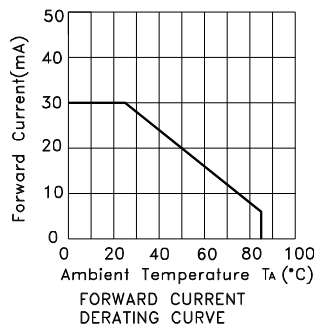
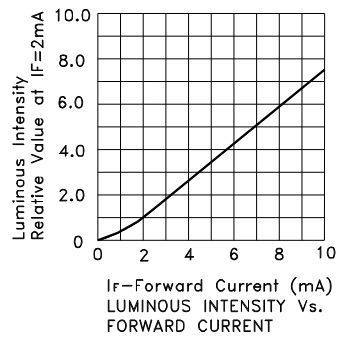
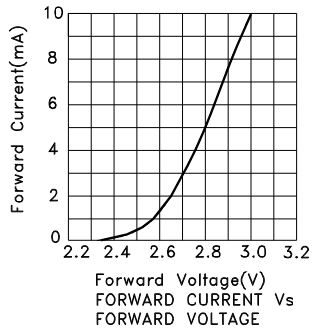

APF3236LSEEZGKBKC

Reflow soldering is recommended and the soldering profile is shown below.
Other soldering methods are not recommended as they might cause damage to the product.

Reflow Soldering Profile For Lead-free SMT Process.

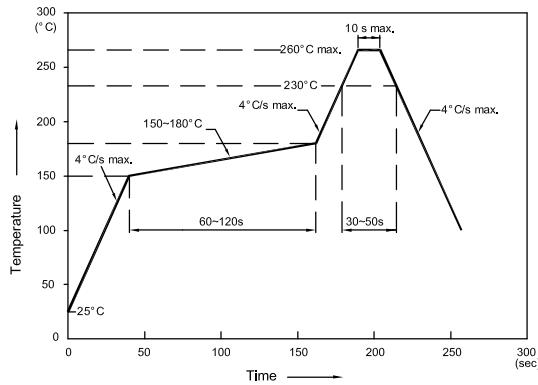

NOTES:

1. We recommend the reflow temperature 245°C (+/-5°C). The maximum soldering temperature should be limited to 260°C.
2. Don't cause stress to the epoxy resin while it is exposed to high temperature.
3. Number of reflow process shall be 2 times or less.

Recommended Soldering Pattern (Units : mm; Tolerance: ± 0.1)

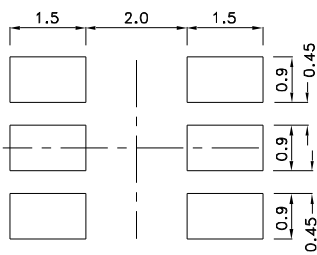

Reel Dimension

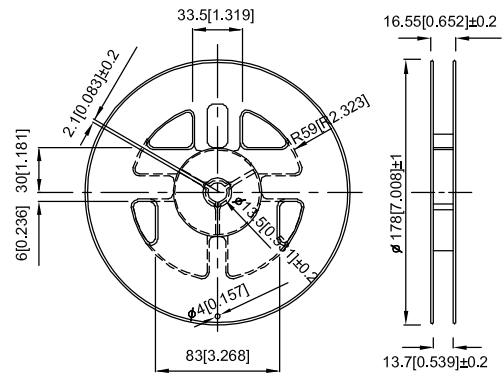

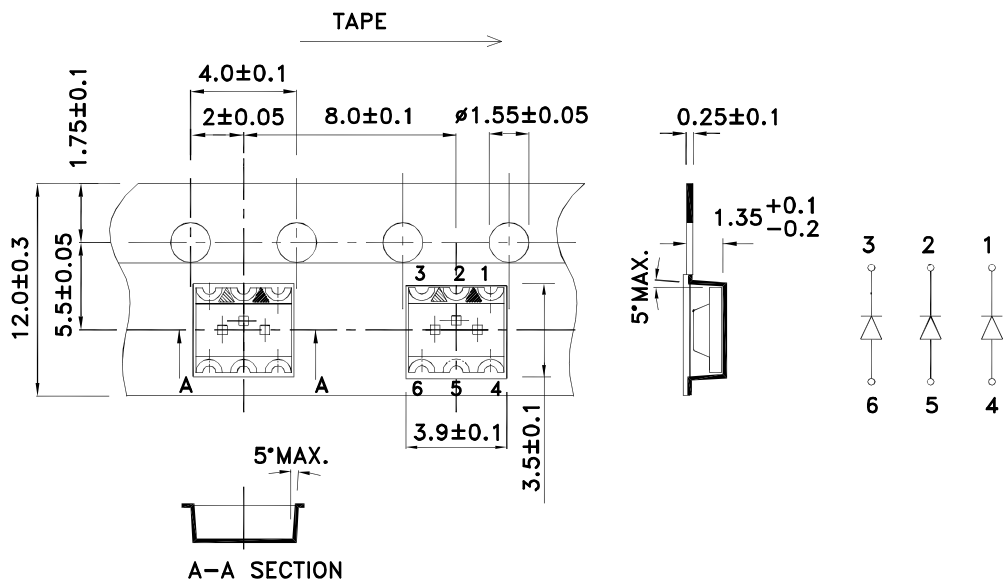

Tape Dimensions (Units : mm)

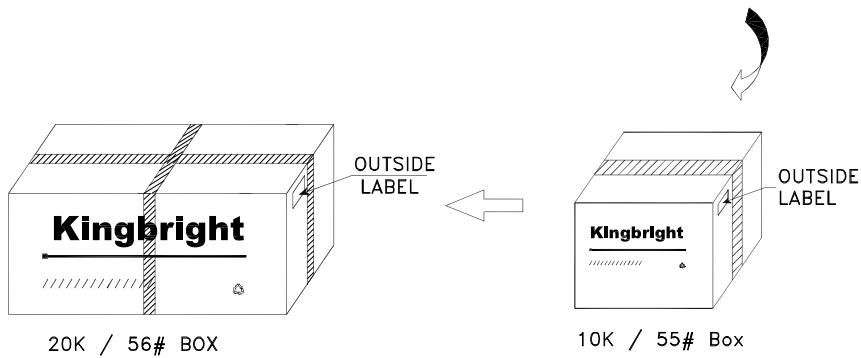
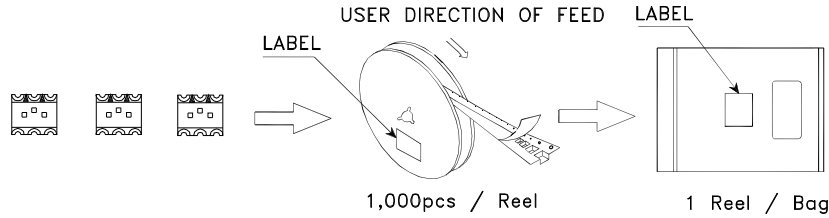

PACKING & LABEL SPECIFICATIONS

APF3236LSEEZGKQBKC



Kingbright	
P/NO: APF3236xxx	
QTY: 1,000 pcs	Q.C. Q C XX XX XXXX PASSED
S/N: XXXX	
CODE: XXX	
LOT NO: 	
RoHS Compliant	

Terms and conditions for the usage of this document

1. The information included in this document reflects representative usage scenarios and is intended for technical reference only.
2. The part number, type, and specifications mentioned in this document are subject to future change and improvement without notice. Before production usage customer should refer to the latest datasheet for the updated specifications.
3. When using the products referenced in this document, please make sure the product is being operated within the environmental and electrical limits specified in the datasheet. If customer usage exceeds the specified limits, Kingbright will not be responsible for any subsequent issues.
4. The information in this document applies to typical usage in consumer electronics applications. If customer's application has special reliability requirements or have life-threatening liabilities, such as automotive or medical usage, please consult with Kingbright representative for further assistance.
5. The contents and information of this document may not be reproduced or re-transmitted without permission by Kingbright.
6. All design applications should refer to Kingbright application notes available at <http://www.KingbrightUSA.com/ApplicationNotes>