



**N-channel Enhancement-mode Power MOSFET**

**Simple Drive Requirement**

**Low On-Resistance**

**Fast Switching Characteristics**

**RoHS-compliant, halogen-free**

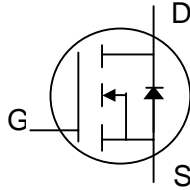

$BV_{DSS}$	40V
$R_{DS(ON)}$	10mΩ
$I_D$	51A

**Description**

Advanced Power MOSFETs from APEC provide the designer with the best combination of fast switching, low on-resistance and cost-effectiveness.

The AP0904GH-HF-3 is in the TO-252 package which is widely preferred for commercial and industrial surface mount applications such as medium-power DC/DC converters. The through-hole TO-251 version (AP0904GJ-HF-3) is available where a small PCB footprint is required.

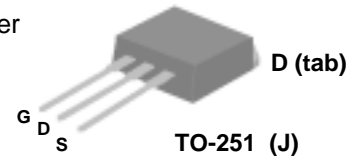

**Absolute Maximum Ratings**

Symbol	Parameter	Rating	Units
$V_{DS}$	Drain-Source Voltage	40	V
$V_{GS}$	Gate-Source Voltage	±20	V
$I_D$ at $T_C=25^\circ C$	Continuous Drain Current	51	A
$I_D$ at $T_C=100^\circ C$	Continuous Drain Current	32	A
$I_{DM}$	Pulsed Drain Current <sup>1</sup>	200	A
$P_D$ at $T_C=25^\circ C$	Total Power Dissipation	44.6	W
	Linear Derating Factor	0.357	W/°C
$T_{STG}$	Storage Temperature Range	-55 to 150	°C
$T_J$	Operating Junction Temperature Range	-55 to 150	°C

**Thermal Data**

Symbol	Parameter	Value	Units
Rthj-c	Maximum Thermal Resistance, Junction-case	2.8	°C/W
Rthj-a	Maximum Thermal Resistance, Junction-ambient (PCB mount) <sup>3</sup>	62.5	°C/W
Rthj-a	Maximum Thermal Resistance, Junction-ambient	110	°C/W

**Ordering Information**

**AP0904GH-HF-3TR** : in RoHS-compliant halogen-free TO-252 shipped on tape and reel (3000 pcs/reel)

**AP0904GJ-HF-3TB** : in RoHS-compliant halogen-free TO-251 shipped in tubes (80pcs/tube)



**Electrical Specifications at  $T_j=25^\circ\text{C}$  (unless otherwise specified)**

Symbol	Parameter	Test Conditions	Min.	Typ.	Max.	Units
$BV_{DSS}$	Drain-Source Breakdown Voltage	$V_{GS}=0V, I_D=250\mu A$	40	-	-	V
$R_{DS(ON)}$	Static Drain-Source On-Resistance <sup>2</sup>	$V_{GS}=10V, I_D=30A$	-	-	10	m $\Omega$
		$V_{GS}=4.5V, I_D=20A$	-	-	15	m $\Omega$
$V_{GS(th)}$	Gate Threshold Voltage	$V_{DS}=V_{GS}, I_D=250\mu A$	1	-	3	V
$g_{fs}$	Forward Transconductance	$V_{DS}=10V, I_D=20A$	-	45	-	S
$I_{DSS}$	Drain-Source Leakage Current	$V_{DS}=40V, V_{GS}=0V$	-	-	10	$\mu A$
$I_{GSS}$	Gate-Source Leakage	$V_{GS}=\pm 20V$	-	-	$\pm 100$	nA
$Q_g$	Total Gate Charge <sup>2</sup>	$I_D=20A$	-	9	14.4	nC
$Q_{gs}$	Gate-Source Charge	$V_{DS}=20V$	-	2	-	nC
$Q_{gd}$	Gate-Drain ("Miller") Charge	$V_{GS}=4.5V$	-	6	-	nC
$t_{d(on)}$	Turn-on Delay Time <sup>2</sup>	$V_{DS}=20V$	-	6.5	-	ns
$t_r$	Rise Time	$I_D=1A$	-	6.5	-	ns
$t_{d(off)}$	Turn-off Delay Time	$R_G=3.3\Omega, V_{GS}=10V$	-	20	-	ns
$t_f$	Fall Time	$R_D=20\Omega$	-	10	-	ns
$C_{iss}$	Input Capacitance	$V_{GS}=0V$	-	680	1080	pF
$C_{oss}$	Output Capacitance	$V_{DS}=25V$	-	160	-	pF
$C_{rss}$	Reverse Transfer Capacitance	$f=1.0MHz$	-	95	-	pF

**Source-Drain Diode**

Symbol	Parameter	Test Conditions	Min.	Typ.	Max.	Units
$V_{SD}$	Forward On Voltage <sup>2</sup>	$I_S=20A, V_{GS}=0V$	-	-	1.2	V
$t_{rr}$	Reverse Recovery Time <sup>2</sup>	$I_S=10A, V_{GS}=0V,$	-	22	-	ns
$Q_{rr}$	Reverse Recovery Charge	$di/dt=100A/\mu s$	-	16	-	nC

**Notes:**

1. Pulse width limited by maximum junction temperature.
2. Pulse test
3. Surface mounted on 1 in<sup>2</sup> copper pad of FR4 board

THIS PRODUCT IS SENSITIVE TO ELECTROSTATIC DISCHARGE, PLEASE HANDLE WITH CAUTION.

USE OF THIS PRODUCT AS A CRITICAL COMPONENT IN LIFE SUPPORT OR OTHER SIMILAR SYSTEMS IS NOT AUTHORIZED.

APEC DOES NOT ASSUME ANY LIABILITY ARISING OUT OF THE APPLICATION OR USE OF ANY PRODUCT OR CIRCUIT DESCRIBED HEREIN; NEITHER DOES IT CONVEY ANY LICENSE UNDER ITS PATENT RIGHTS, NOR THE RIGHTS OF OTHERS.

APEC RESERVES THE RIGHT TO MAKE CHANGES WITHOUT FURTHER NOTICE TO ANY PRODUCTS HEREIN TO IMPROVE RELIABILITY, FUNCTION OR DESIGN.



Typical Electrical Characteristics

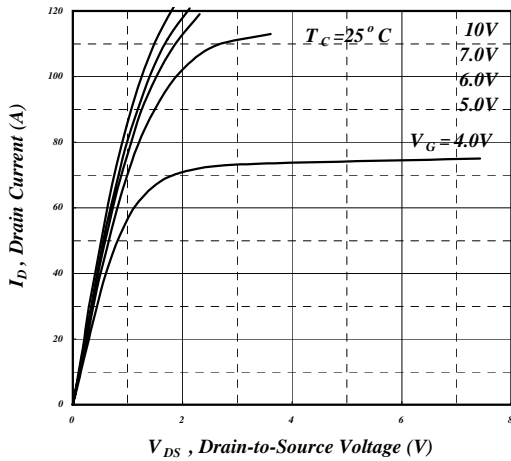

Fig 1. Typical Output Characteristics

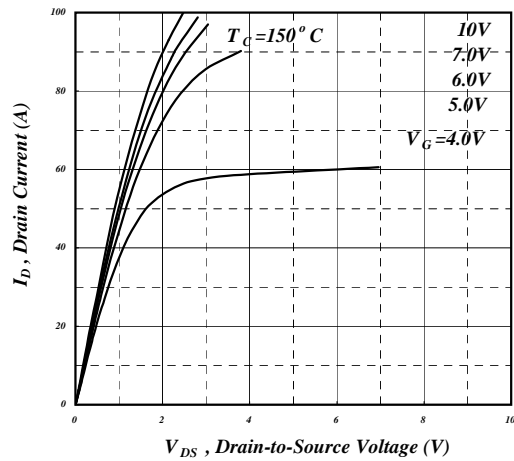

Fig 2. Typical Output Characteristics

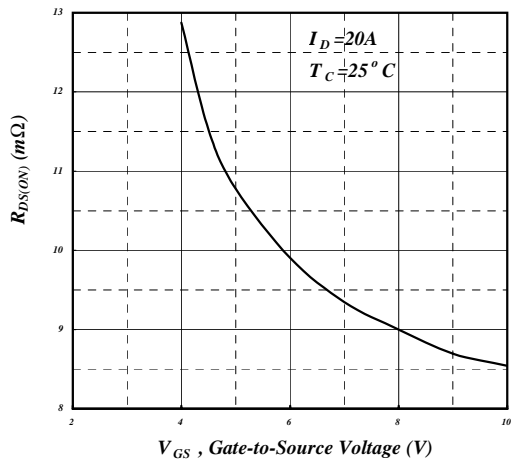

Fig 3. On-Resistance vs. Gate Voltage

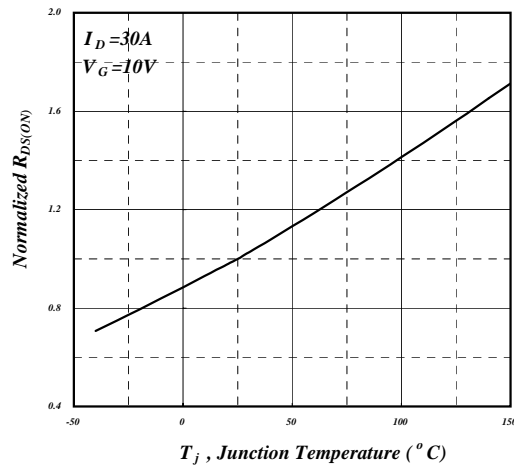

Fig 4. Normalized On-Resistance vs. Junction Temperature

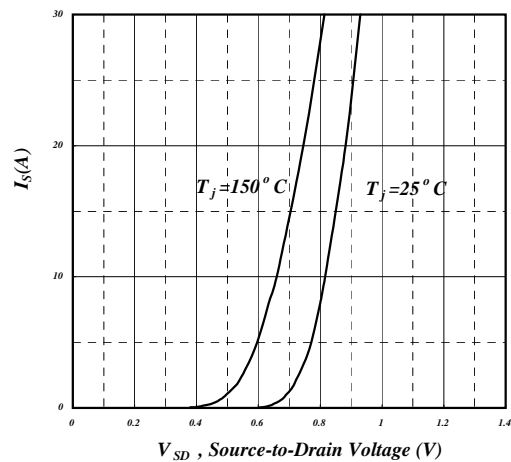

Fig 5. Forward Characteristic of Reverse Diode

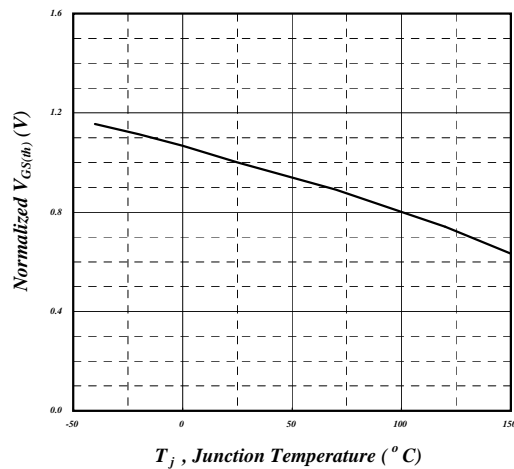

Fig 6. Gate Threshold Voltage vs. Junction Temperature



Typical Electrical Characteristics (cont.)

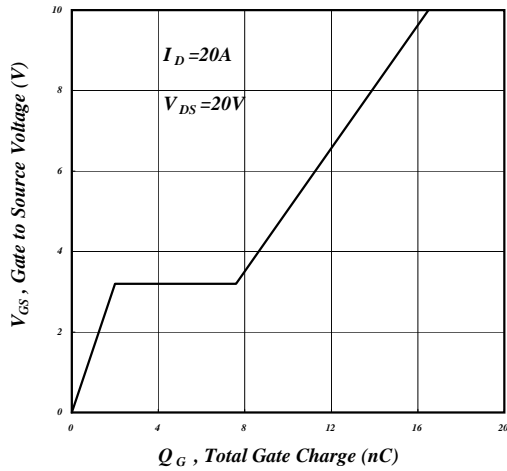

Fig 7. Gate Charge Characteristics

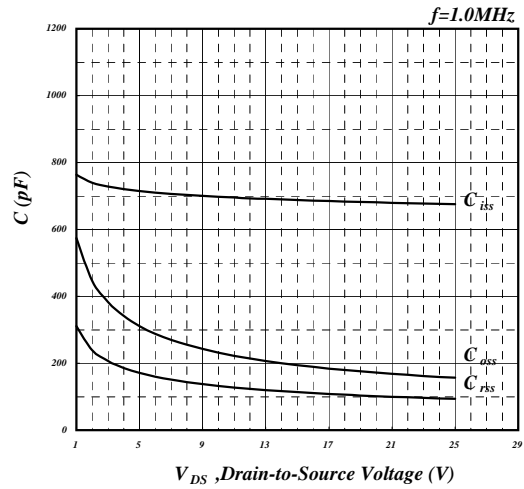

Fig 8. Typical Capacitance Characteristics

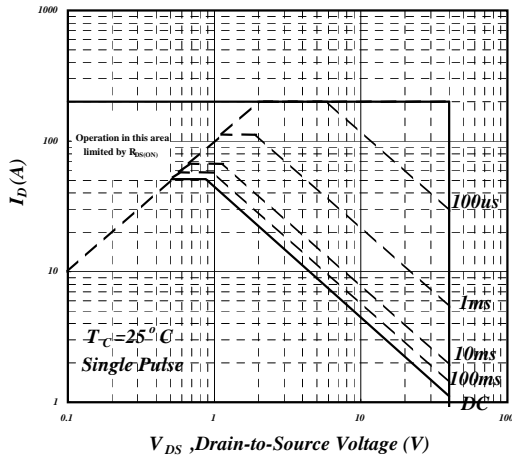

Fig 9. Maximum Safe Operating Area

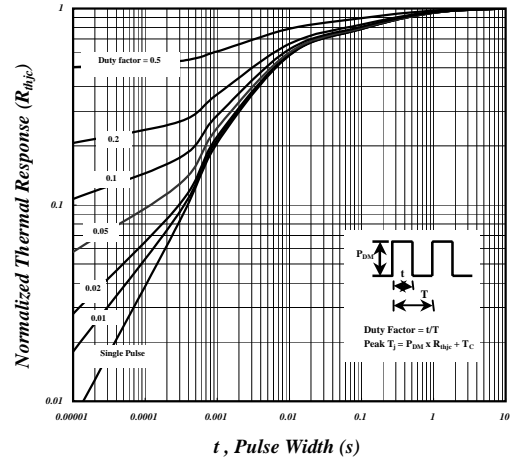

Fig 10. Effective Transient Thermal Impedance

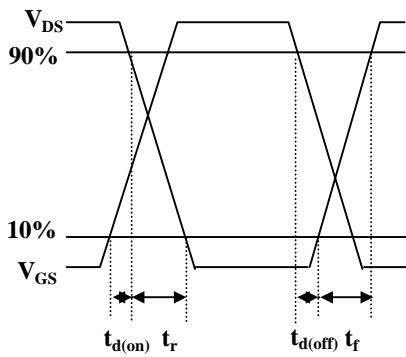

Fig 11. Switching Time Waveform

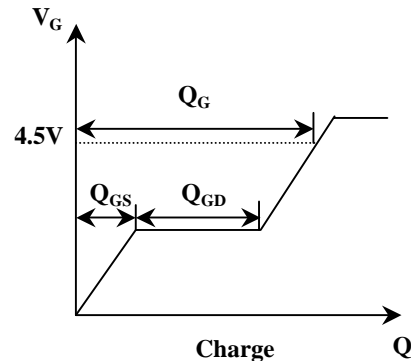

Fig 12. Gate Charge Waveform



**Package Dimensions: TO-252**



SYMBOLS	Millimeters		
	MIN	NOM	MAX
A2	1.80	2.30	2.80
A3	0.40	0.50	0.60
B1	0.40	0.70	1.00
D	6.00	6.50	7.00
D1	4.80	5.35	5.90
E3	3.50	4.00	4.50
F	2.20	2.63	3.05
F1	0.50	0.85	1.20
E1	5.10	5.70	6.30
E2	0.50	1.10	1.80
e	--	2.30	--
C	0.35	0.50	0.65

1. All dimensions are in millimeters.
2. Dimensions do not include mold protrusions.



**Marking Information:**

Laser Marking

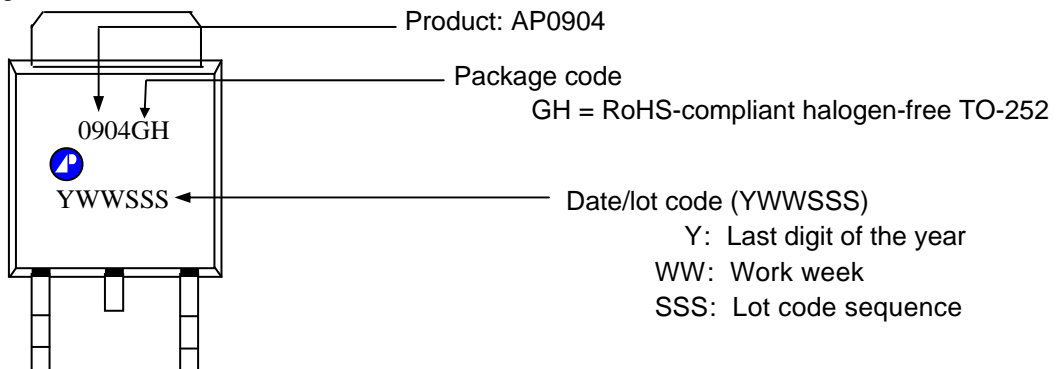



**Package Dimensions: TO-251**

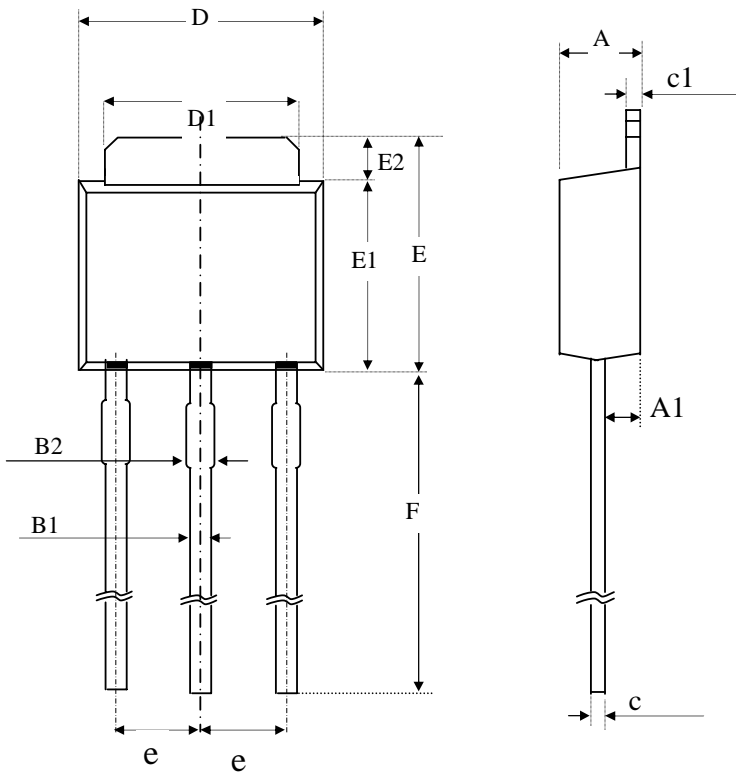

SYMBOLS	Millimeters		
	MIN	NOM	MAX
A	2.20	2.30	2.40
A1	0.90	1.20	1.50
B1	0.40	0.60	0.80
B2	0.60	0.85	1.05
c	0.40	0.50	0.60
c1	0.40	0.50	0.60
D	6.40	6.60	6.80
D1	4.80	5.20	5.50
E	6.70	7.00	7.30
E1	5.40	5.60	5.80
E2	1.30	1.50	1.70
e	----	2.30	----
F	7.00	8.30	9.60

1. All dimensions are in millimeters.
2. Dimensions do not include mold protrusions.

**Marking Information:**

