



Technologies Int'l

WFP12N60

600V N-Channel MOSFET

Features

- Low Intrinsic Capacitances
- Excellent Switching Characteristics
- Extended Safe Operating Area
- Unrivalled Gate Charge :Qg= 37nC (Typ.)
- BVDSS=600V, ID=12A
- R_{DS(on)} :0.65 Ω (Max) @VG=10V
- 100% Avalanche Tested

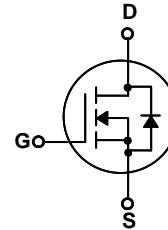
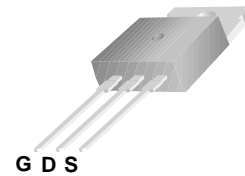

TO-220

G-Gate,D-Drain,S-Source

Absolute Maximum Ratings *Tc=25 °C unless other wise noted*

Symbol	Parameter	WFP12N60	Units
V _{DSS}	Drain-Source Voltage	600	V
I _D	Drain Current -continuous (Tc=25°C)	12	A
	-continuous (Tc=100°C)	6.7	A
V _{GS}	Gate-Source Voltage	± 30	V
E _{AS}	Single Plused Avanche Energy (Note1)	870	mJ
I _{AR}	Avalanche Current (Note2)	12	A
P _D	Power Dissipation (Tc=25°C)	225	W
T _J , T _{STG}	Operating and Storage Temperature Range	-55 ~ +150	°C
TL	Maximum lead temperature for soldering purpose, 1/8" from case for 5 seconds	300	°C

Thermal Characteristics

Symbol	Parameter	Typ.	Max	Units
R _{θJC}	Thermal Resistance, Junction to Case	--	0.7	°C/W
R _{θCS}	Thermal Resistance, Case to Sink	0.5	--	°C/W
R _{θJA}	Thermal Resistance, Junction to Ambient	--	62.5	°C/W

Electrical Characteristics $T_c=25^\circ\text{C}$ unless other wise noted

Symbol	Parameter	Test Condition	Min.	Typ.	Max	Units
--------	-----------	----------------	------	------	-----	-------

Off Characteristics

BV_{DSS}	Drain-Source Breakdown Voltage	$I_D=250\ \mu\text{A}, V_{GS}=0$	600	--	--	V
$\Delta BV_{DSS}/\Delta T_J$	Breakdown Voltage Temperature Coefficient	$I_D=250\ \mu\text{A}$, Reference to 25°C	--	0.71	--	$\text{V}/^\circ\text{C}$
I_{DSS}	Zero Gate Voltage Drain Current	$V_{ds}=600\text{V}, V_{gs}=0\text{V}$	--	--	10	μA
		$V_{ds}=480\text{V}, T_c=125^\circ\text{C}$			100	μA
I_{GSSF}	Gate-body leakage Current, Forward	$V_{gs}=+30\text{V}, V_{ds}=0\text{V}$	--	--	100	nA
I_{GSSR}	Gate-body leakage Current, Reverse	$V_{gs}=-30\text{V}, V_{ds}=0\text{V}$	--	--	-100	nA

On Characteristics

$V_{GS(th)}$	Gate Threshold Voltage	$I_D=250\ \mu\text{A}, V_{ds}=V_{gs}$	2	--	4	V
$R_{DS(on)}$	Static Drain-Source On-Resistance	$I_D=6\text{A}, V_{gs}=10\text{V}$	--	--	0.65	Ω

Dynamic Characteristics

C_{iss}	Input Capacitance	$V_{DS}=25\text{V}, V_{GS}=0,$ $f=1.0\text{MHz}$	--	1480	1900	pF
C_{oss}	Output Capacitance		--	200	270	pF
C_{rss}	Reverse Transfer Capacitance		--	25	35	pF

Switching Characteristics

$T_d(on)$	Turn-On Delay Time	$V_{DD}=300\text{V}, I_D=12\text{A}$ $R_G=25\ \Omega$ (Note 3,4)	--	30	70	nS
T_r	Turn-On Rise Time		--	115	240	nS
$T_d(off)$	Turn-Off Delay Time		--	95	200	nS
T_f	Turn-Off Fall Time		--	85	180	nS
Q_g	Total Gate Charge	$V_{DS}=480, V_{GS}=10\text{V},$ $I_D=12\text{A}$ (Note 3,4)	--	42	54	nC
Q_{gs}	Gate-Source Charge		--	8.6	--	nC
Q_{gd}	Gate-Drain Charge		--	21	--	nC

Drain-Source Diode Characteristics and Maximum Ratings

I_S	Maximum Continuous Drain-Source Diode Forward Current	--	--	12	A	
I_{SM}	Maximum Pulsed Drain-Source Diode Forward Current	--	--	48	A	
V_{SD}	Drain-Source Diode Forward Voltage	$I_D=12\text{A}$	--	--	1.4	V
t_{rr}	Reverse Recovery Time	$I_S=12\text{A}, V_{GS}=0\text{V}$ $di_f/dt=100\text{A}/\mu\text{s}$ (Note3)	--	380	--	nS
Q_{rr}	Reverse Recovery Charge		--	3.5	--	μC

- *Notes
- 1, $L=11.1\text{mH}, I_{AS}=12\text{A}, V_{DD}=50\text{V}, R_G=25\Omega$, Starting $T_J=25^\circ\text{C}$
 - 2, Repetitive Rating : Pulse width limited by maximum junction temperature
 - 3, Pulse Test : Pulse Width $\leq 300\ \mu\text{s}$, Duty Cycle $\leq 2\%$
 - 4, Essentially Independent of Operating Temperature

Typical Characteristics

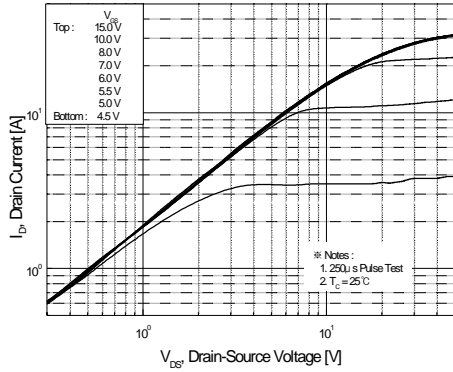

Figure 1. On-Region Characteristics

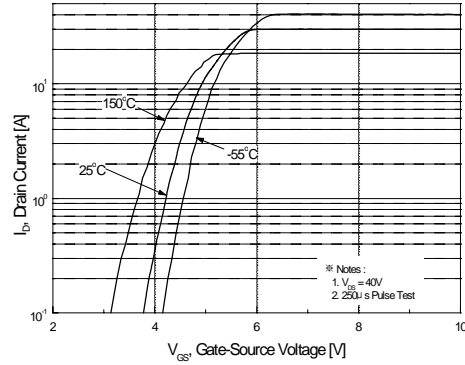

Figure 2. Transfer Characteristics

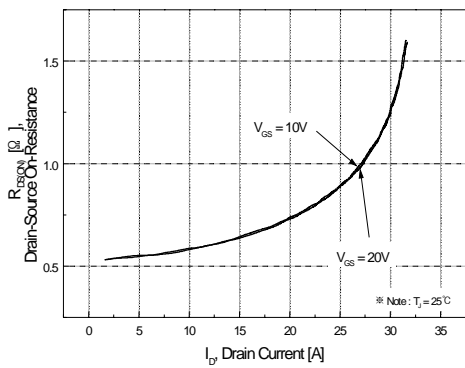

Figure 3. On-Resistance Variation vs Drain Current and Gate Voltage

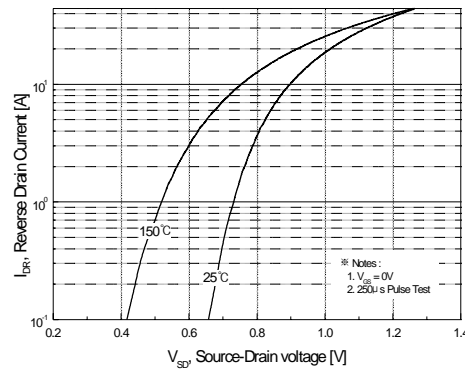

Figure 4. Body Diode Forward Voltage Variation with Source Current and Temperature

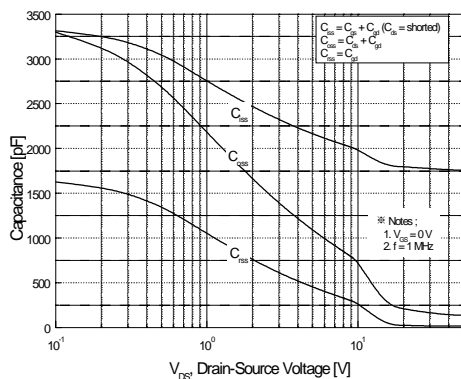

Figure 5. Capacitance Characteristics

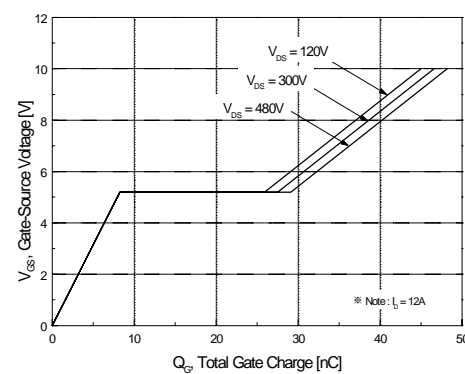

Figure 6. Gate Charge Characteristics

Typical Characteristics (Continued)

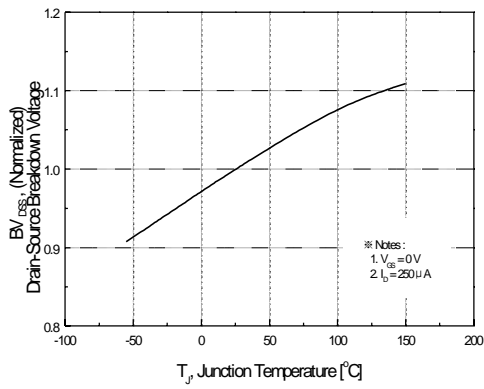

Figure 7. Breakdown Voltage Variation vs Temperature

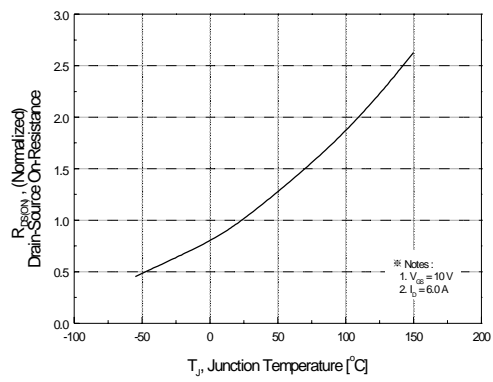

Figure 8. On-Resistance Variation vs Temperature

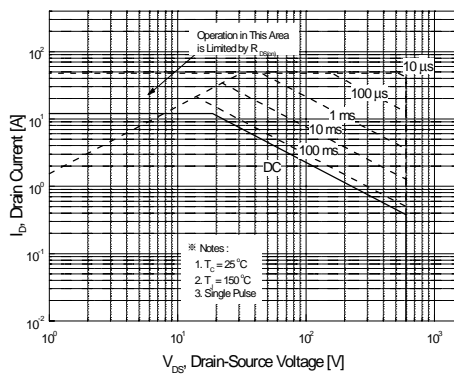

Figure 9-1. Maximum Safe Operating Area for WFP12N60

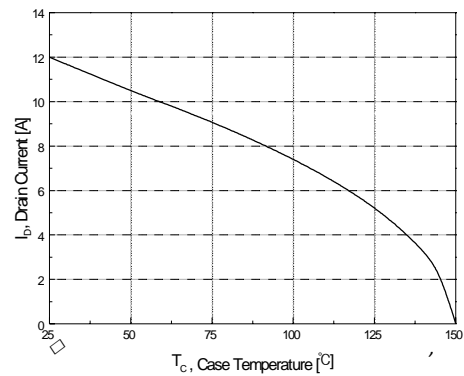

Figure 10. Maximum Drain Current vs Case Temperature

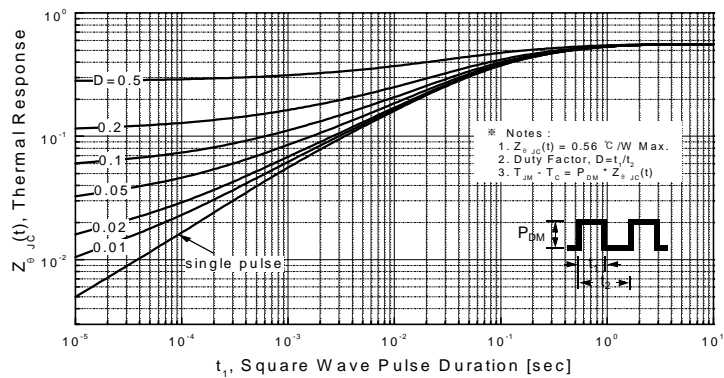
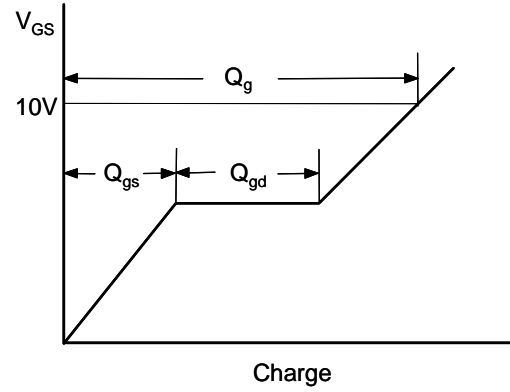
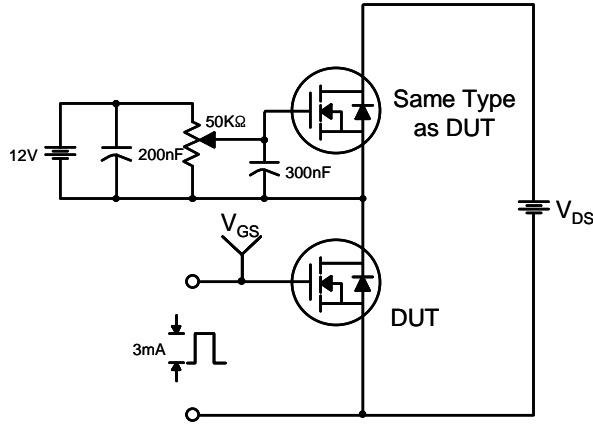
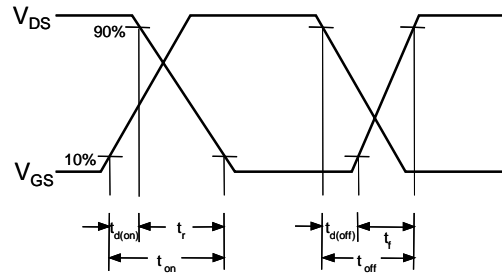
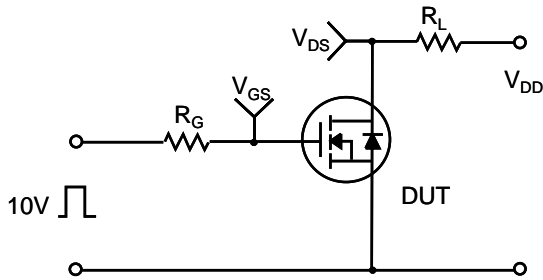

Figure 11-1. Transient Thermal Response Curve for WFP12N60

Gate Charge Test Circuit & Waveform



Resistive Switching Test Circuit & Waveforms



Unclamped Inductive Switching Test Circuit & Waveforms

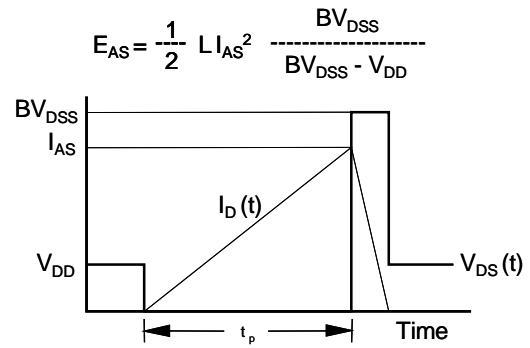
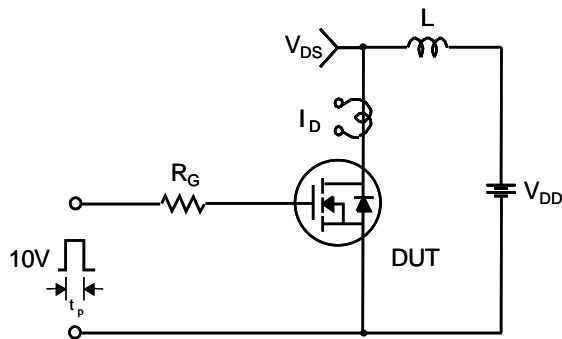

Peak Diode Recovery dv/dt Test Circuit & Waveforms

