

# Neuron<sup>®</sup> 5000 Processor

The Next-generation Neuron Chip  
for LONWORKS<sup>®</sup> Control Networks

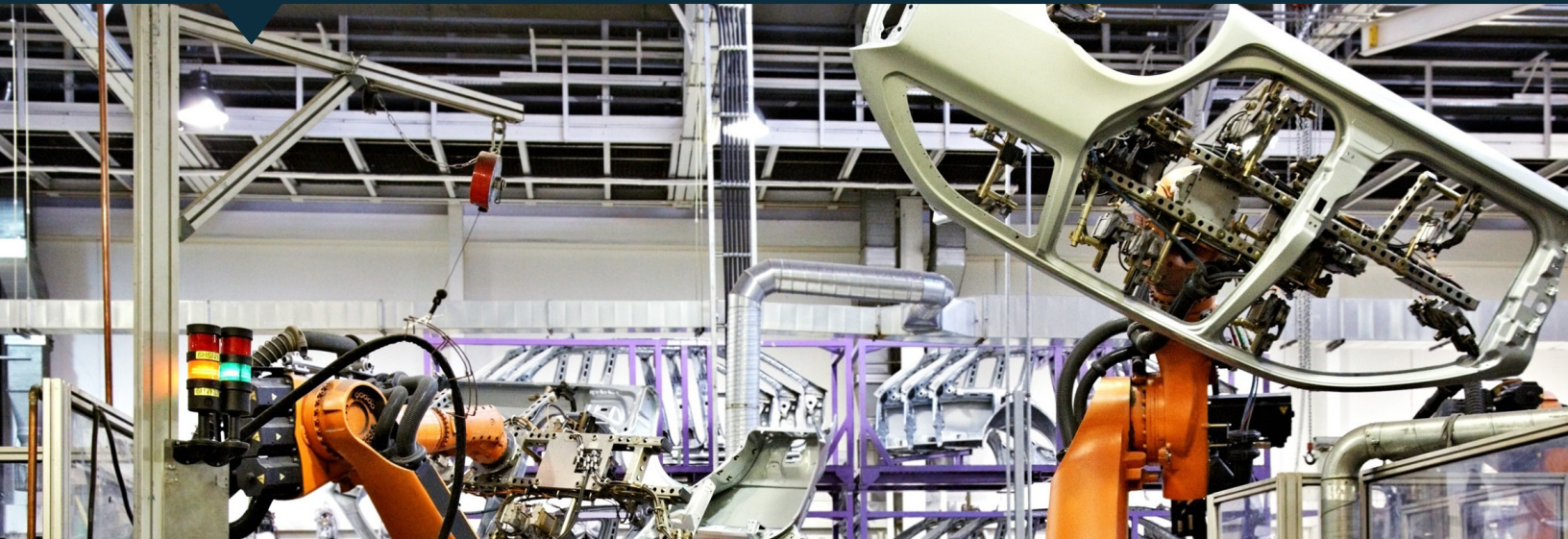

Combined with inexpensive serial memory, the Neuron 5000 Processor provides a lower-cost, higher-performance LonWorks solution than those based on previous-generation Neuron 3120<sup>®</sup> and Neuron 3150<sup>®</sup> chips.

The Neuron 5000 Processor incorporates communication and control functions on a single chip, in both hardware and firmware, to facilitate the design of a LONWORKS device. Its flexible 5-pin communications port can be configured to interface with a wide variety of media transceivers — including twisted-pair, RF, IR, fiber-optics, and coaxial — at a wide range of data rates.

## Features

- 3.3V operation.
- Higher-performance Neuron<sup>®</sup> Core — internal system clock scales up to 80 MHz.
- Enables lower-cost device designs.
- Serial memory interface for inexpensive external EEPROM and flash non-volatile memories.
- Supports up to 254 Network Variables (NVs) and 127 aliases.
- User programmable interrupts provide faster response time to external events.
- Includes hardware UART with 16-byte receive and transmit FIFOs.
- 7mm x 7mm 48-pin QFN package.
- 5-pin network communications port with 3.3V drive and 5V-tolerant pins.
- 12 I/O pins with 35 programmable standard I/O models.
- Supports up to 42KB of application code space.
- 64KB RAM (44KB user accessible) and 16KB ROM on-chip memories.
- Unique 48-bit Neuron ID in every device for network installation and management.
- -40°C to +85°C operating temperature range.

## Description

The Neuron 5000 Processor includes 3 independent 8-bit logical processors to manage the physical MAC layer, the network, and the user application. These are called the Media-Access Control (MAC) processor, the network (NET) processor, and the application (APP) processor, respectively (see Figure 1). At higher system clock rates, there is also a fourth processor to handle interrupts.

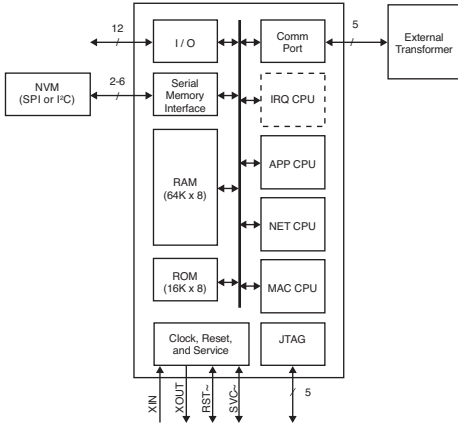

Figure 1: Neuron 5000 Processor

## Backward Compatibility

The pins for the Neuron 5000 Processor's communications port drive a 3.3V signal and are 5V input-tolerant. Thus, the Neuron 5000 Processor is compatible with 3.3V transceivers and with 5V transceivers that have TTL-compatible input.

The Neuron 5000 Processor is compatible with TP/XF-1250 and EIA-485 channels, and can be used with the LonWorks LPT-11 Link Power Transceiver. It also supports a variety of other channels used with previous-generation Neuron Chips, such as RF, IR, fiber-optic, and coaxial. It does not, however, support a TP/XF-78 channel. To support a TP/FT-10 channel, use an Echelon Free Topology Smart Transceiver (FT 5000 Smart Transceiver); to support a PL-20 power line channel, use an Echelon Power Line Smart Transceiver (PL 3120/3150/3170 Smart Transceiver). Echelon's Smart Transceivers integrate the transceiver for the channel type and the Neuron Core into a single chip, which enables smaller designs and provides cost savings.

The Neuron Core in the Neuron 5000 Processor uses the same instruction set and architecture as the previous-generation Neuron Core, with 2 new additional instructions for hardware multiplication and division. The Series 5000 Neuron Core is source code compatible with applications written for the Series 3100 Neuron Core. Applications written for the Series 3100

Neuron Core must be recompiled with the NodeBuilder<sup>®</sup> FX Development Tool or the Mini FX Evaluation Kit before they can be used with the Neuron 5000 Processor.

The Neuron 5000 Processor uses Neuron firmware version 19. Firmware versions prior to version 19 are not compatible with the Neuron 5000 Processor. The Neuron firmware is pre-programmed into the on-chip ROM. The Neuron 5000 Processor can also be configured to read newer firmware from external memories, allowing the firmware to be upgraded over time.

## Enhanced Performance

**Faster system clock.** The internal system clock for the Neuron 5000 Processor can be user-configured to run from 5MHz to 80MHz. The required external crystal provides a 10MHz clock frequency, and an internal PLL boosts the frequency to a maximum of 80MHz as the internal system clock speed. The previous-generation Neuron 3120/3150 Core divided the external oscillator frequency by two to create the internal system clock. Hence, a Neuron 3120/3150 Core running with a 10MHz external crystal had a 5MHz internal system clock. A Neuron 5000 Processor running with an 80MHz internal clock is thus 16 times faster than a 10MHz Neuron 3120/3150 Core running with a 5MHz internal system clock.

The 5MHz system clock mode in the Neuron 5000 Processor provides backward compatibility to support time-critical applications designed for the 10MHz Neuron 3150 or Neuron 3120 processor.

The Neuron Core inside the Neuron 5000 Processor includes a built-in hardware multiplier and divider to increase the performance of arithmetic operations.

**Support for more network variables.** Because it uses Neuron system firmware Version 19, the Neuron 5000 Processor supports applications with up to 254 network variables and 127 aliases for Neuron hosted devices (devices without a host microprocessor). A Series 3100 Neuron Chip or Smart Transceiver with Neuron firmware Version 15 or earlier supports up to 62 network variables and 62 aliases for Neuron hosted devices. Series 3100 chips with Neuron firmware version 16 or later support up to 254 network variables. You must use the NodeBuilder FX Development Tool to take advantage of 254 network variables.

**Interrupts.** The Neuron 5000 Processor lets developers define application interrupts to handle asynchronous events triggered by selected state changes on any of the 12 I/O pins, by on-chip hardware timer-counter units, or by an on-chip high-

performance hardware system timer. An application uses the Neuron C **interrupt()** clause to define the interrupt condition and the interrupt task that handles the condition. The Neuron C program runs the interrupt task whenever the interrupt condition is met. See the *Neuron C Programmer's Guide* for more information about writing interrupt tasks and handling interrupts.

**JTAG.** The Neuron 5000 Processor provides an interface for the Institute of Electrical and Electronics Engineers (IEEE) Standard Test Access Port and Boundary-Scan Architecture (IEEE 1149.1-1990) of the Joint Test Action Group (JTAG) to allow a Series 5000 chip to be included in the boundary-scan chain for device production tests. A Boundary Scan Description Language (BSDL) file for the Neuron 5000 Processor can be downloaded from Echelon's Web site.

## Communications Port

The Neuron 5000 Processor includes a versatile 5-pin communications port that can be configured in two ways: 3.3 V Single-Ended Mode and 3.3 V Special-Purpose Mode. In Single-Ended Mode, pin CPO is used for receiving serial data, pin CP1 for transmitting serial data, and pin CP2 for enabling an external transmitter. Data is communicated using Differential Manchester encoding.

In Special-Purpose Mode, pin CPO is used for receiving serial data, pin CP1 for transmitting serial data, pin CP2 transmits a bit clock, and pin CP4 transmits a frame clock for use by an external intelligent transceiver. In this mode, the external transceiver is responsible for encoding and decoding the data stream.

Unlike the Neuron 3120/3150 Chips, the Neuron 5000 Processor does not support the Differential Mode configuration for the communications port. Thus, devices that require Differential Mode transceiver types must be redesigned for a Neuron 5000 Processor to use Single-Ended Mode with external circuitry to provide Single-Ended to Differential Mode conversions. See the *Series 5000 Chip Data Book and the Connecting a Neuron 5000 Processor to an External Transceiver Engineering Bulletin* for more information.

Any 3.3V transceiver or a 5V transceiver with TTL-compatible inputs can be used with the Neuron 5000 Processor because the communications port has pins that are 5V tolerant and drive a 3.3V signal. Common transceiver types that can be used with a Neuron 5000 Processor include twisted-pair, RF, IR, fiber-optic, and coaxial.

## I/O Pins and Counters

The Neuron 5000 Processor provides 12 bidirectional I/O pins that are 5V tolerant and can be configured to operate in one or more of 35 predefined standard input/output models. The chip also has two 16-bit timer/counters that reduce the need for external logic and software development.

## Memory Architecture

The Neuron 5000 Processor uses inexpensive external serial EEPROM and flash memories for non-volatile application and data storage, and optionally for future Neuron firmware upgrades. It has 16KB of ROM and 64KB (44 KB user-accessible) of RAM on the chip. It has no on-chip non-volatile memory (EEPROM or flash) for application use. Each chip, however, contains its unique Neuron identifier (Neuron ID) in an on-chip, non-volatile, read-only memory.

The application code and configuration data are stored in the external non-volatile memory (NVM) and copied into the internal RAM during device reset; the instructions then execute from internal RAM. Writes to NVM are shadowed in the internal RAM and pushed out to external NVM by the Neuron firmware (see Figure 1). The application does manage NVM directly.

**External memories supported.** The Neuron 5000 Processor supports two serial interfaces for accessing off-chip non-volatile memories: serial Inter-Integrated Circuit (I<sup>2</sup>C) and serial peripheral interface (SPI). EEPROM and flash memory devices can use either the I<sup>2</sup>C interface or the SPI interface; flash memory devices must use the SPI interface.

External serial EEPROMs and flash devices, which are inexpensive and come in very small form factors, are available from many vendors.

The Neuron 5000 Processor requires at least 2KB of off-chip memory available in an EEPROM device to store the configuration data. The application code can be stored either in the EEPROM (by using a larger-capacity EEPROM device) or in a flash memory device used in addition to the 2KB (minimum) EEPROM. Thus, the external memory for a Neuron 5000 Processor has one of the configurations listed in Table 1:

Configuration	EEPROM		Flash	Comments
	I <sup>2</sup> C	SPI	SPI	
1	☑			A single I <sup>2</sup> C EEPROM memory device, from 2KB to 64KB in size.

Configuration	EEPROM		Flash	Comments
	I <sup>2</sup> C	SPI	SPI	
2	☑		☑	One I <sup>2</sup> C EEPROM (at least 2KB in size, up to 64KB in size, but the system uses only the first 2KB of the EEPROM memory). One SPI flash memory device.
3		☑		A single SPI EEPROM memory device, from 2KB to 64KB in size.
4		☑	☑	One SPI EEPROM (at least 2KB in size, up to 64KB in size, but the system uses only the first 2KB of the EEPROM memory). One SPI flash memory device.

Table 1: Allowed External Memory Device Configurations

As Table 1 shows, the Neuron 5000 Processor supports using a single EEPROM memory device, or a single EEPROM memory device plus a single flash memory device.

If the Neuron 5000 Processor detects an external flash memory device, the flash memory represents the entire user non-volatile memory for the device. That is, any additional EEPROM memory beyond the mandatory 2KB is not used.

**Using the I<sup>2</sup>C interface.** When using the I<sup>2</sup>C interface for external EEPROM, the Neuron 5000 Processor is always the master I<sup>2</sup>C device (see Figure 2). The clock speed supported for the I<sup>2</sup>C serial memory interface is 400kHz (fast I<sup>2</sup>C mode). The I<sup>2</sup>C memory device must specify I<sup>2</sup>C address 0. Both 1-byte and 2-byte address modes are supported, but 3-byte addressing mode is not.

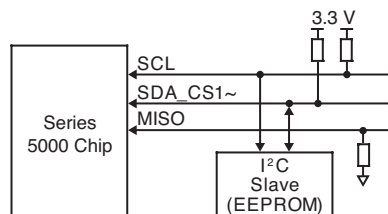

Figure 2: Using the I<sup>2</sup>C Interface for External NVM EEPROM Memory

**Using the SPI interface.** The Neuron 5000 Processor is always the master SPI device; any external NVM devices are always slave devices. The Neuron 5000 Processor can

support up to two SPI slave devices from the serial memory interface: one EEPROM device at CS0- and one flash device at CS1- (see Figure 3). The Neuron 5000 Processor supports 2-byte addressing mode for SPI EEPROM devices, but does not support 3-byte addressing. The Neuron 5000 Processor runs the SPI protocol from the serial memory interface at 2.5MHz and supports SPI Mode 0. In Mode 0, the base value of the clock is zero; the data is read on the clock's rising edge and changed on the clock's falling edge. Most external NVMs support SPI Modes 0 and 3.

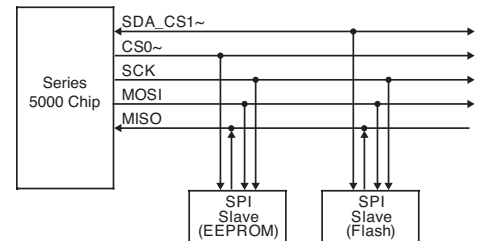

Figure 3: Using the SPI Interface for External NVM Memories

**Using both I<sup>2</sup>C and SPI interfaces.** Figure 4 shows a Neuron 5000 Processor that includes both an I<sup>2</sup>C memory device (a 2KB EEPROM device) and a SPI memory device (a flash memory device). Although both EEPROM and flash memory share the SDA\_CS1- pin, there is no conflict because only one of them can be active at a time. SDA is an active high signal and CS1- is an active low signal. While small applications could use EEPROM both for application code and configuration data, larger applications might find it economical to use a small EEPROM for configuration data and a flash device for application code. The choice between EEPROM and flash can be affected by multiple factors, including:

- Use of a single external memory versus two memories.
- Cost comparison between a large EEPROM device and a combination of a small EEPROM and large flash devices.
- Use of non-volatile variables by the application, which can require a large number of writes to the device.



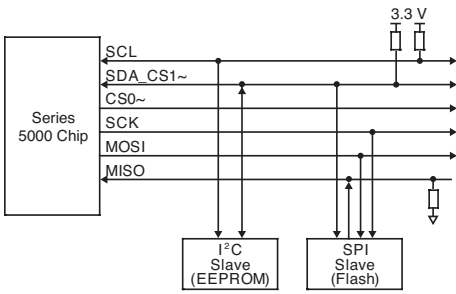

Figure 4: Using both I<sup>2</sup>C and SPI Interfaces for External NVM Memories

**Memory devices supported.** The Neuron 5000 Processor supports any EEPROM device that uses the SPI or I<sup>2</sup>C protocol, and meets the clock speed and addressing requirements described above.

While all EEPROM devices have a uniform write procedure, flash devices from various manufacturers differ slightly in their write procedure. Thus, a small library routine is stored in the external EEPROM device that helps the system write successfully to the external flash device. Echelon has qualified the following SPI flash memory devices for use with the Neuron 5000 Processor:

- Atmel® AT25F512B 512-Kilobit 2.7-volt Minimum SPI Serial Flash Memory.
- Numonyx™ M25P05-A 512-Kbit, serial flash memory, 50MHz SPI bus interface.
- Silicon Storage Technology SST25VF512A 512 Kbit SPI Serial Flash.
- Additional devices may be qualified in the future.

**Memory map.** A Neuron 5000 Processor has a memory map of 64KB. A Neuron C application program uses this memory map to organize its memory and data access. The memory map is a logical view of device memory, rather than a physical view, because the chip's processors only directly access RAM. The memory map divides the Neuron 5000 Processor's physical 64KB RAM into the following types of logical memory, as shown in Figure 5:

- System firmware image (stored in on-chip ROM or external NVM).
- On-chip RAM or NVM. Memory ranges for each are configurable within the device hardware template. The non-volatile memory represents the area shadowed from external NVM into the RAM.

- On-chip RAM for stack segments and RAMNEAR data.
- Mandatory external EEPROM that holds configuration data and non-volatile application variables.
- Reserved space for system use.

If a 64KB external serial EEPROM or flash device is used, the maximum allowed size of application code is 42KB as defined by extended NVM area in the memory map. An additional 16KB of the remaining space can hold an external system firmware image, in case a future firmware upgrade is required.

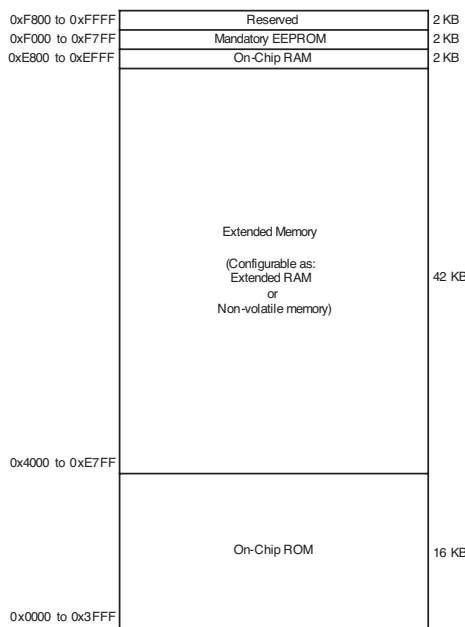

Figure 5: FT 5000 Smart Transceiver Memory Map

**Programming memory devices.** Because the Neuron 5000 Processor does not have any on-chip user-accessible NVM, only the external serial EEPROM or flash devices need to be programmed with the application and configuration data. The memory devices can be programmed in any of the following ways:

In-circuit programming on the board.

Over the network.

Pre-programming before soldering on the board.

## Migration Considerations

Most device designs that use the previous-generation Neuron 3120 or Neuron 3150 Chip can transition to using the Neuron 5000 Processor. However, because the supply voltage and memory architecture of Neuron 3120/3150 Chips and Neuron 5000 Processors are different, the transition

requires a hardware redesign of the boards.

The recommended migration path for devices based on a Neuron Chip depends on the transceiver type used with the Neuron Chip, as shown in Table 2.

Current Transceiver Type Used	Equivalent Series 5000 Design	Comments
FTT-10A Transceiver	FT 5000 Smart Transceiver plus FT-X3 Communications Transformer	Use an FT 5000 Smart Transceiver for TP/FT-10 channels.
EIA-485 Transceiver	Neuron 5000 Processor plus EIA-485 Transceiver or (if possible) FT 5000 Smart Transceiver plus FT-X3 Communications Transformer	If your design is flexible enough to allow either an EIA-485 channel or a TP/FT-10 channel, use the FT 5000 Smart Transceiver with the TP/FT-10 channel.
TPT Twisted Pair Transceiver Module (for a TP/XF-1250 channel type)	Neuron 5000 Processor plus TPT/XF-1250 Twisted Pair Transceiver Module (for a TP/XF-1250 channel type)	The Neuron 5000 Processor must be configured to operate in 3.3V Single-Ended Mode with the TPT Twisted Pair Transceiver Module and external circuitry must be added for Single-Ended to Differential Mode conversion.
LonWorks LPT-11 Link Power Transceiver	Neuron 5000 Processor plus LPT-11 Link Power Transceiver	The Neuron 5000 Processor must be configured to operate in 3.3V Single-Ended Mode with the LPT-11 Link Power Transceiver.
Other transceiver type	Neuron 5000 Processor plus other transceiver type	The Neuron 5000 Processor can connect to other transceiver types for the supported channel types, but more hardware design work may be required.

Table 2: Migration for Devices with Neuron Chips

See the **Series 5000 Chip Data Book and the Connecting a Neuron 5000 Processor to an External Transceiver** Engineering Bulletin for more information about migrating device designs for Neuron 3120/3150 Chips to Neuron 5000 Processors.

## End-to-End Solutions

A typical Neuron 5000 Processor-based device requires a power source, crystal, external memory, and an I/O interface to the device being controlled (see Figure 6 for a typical Neuron 5000 Processor-based device).

Echelon provides all of the building blocks required to successfully design and field cost-effective, robust products based on the Neuron 5000 Processor. Our end-to-end solutions include a comprehensive set of development tools, network interfaces, routers, and network tools. Pre-production design review services, training, and worldwide technical support—including on-site support—are available through Echelon's Support technical assistance program.

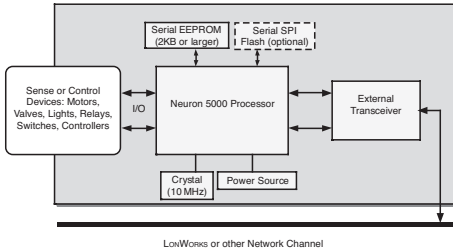

Figure 6: Typical LonWorks based Device Neuron 5000 Processor Pin Configuration

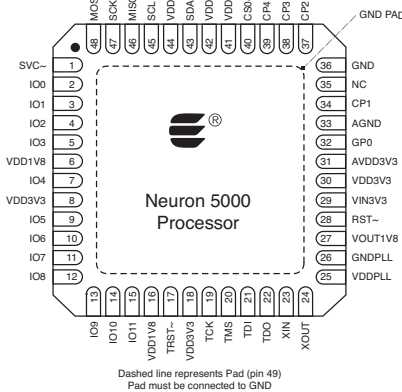

Figure 7: Neuron 5000 Processor Pinout

## Neuron 5000 Processor Pin Descriptions

All digital inputs are low-voltage transistor-transistor logic (LVTTTL) compatible, low leakage, 5V-tolerant. All digital outputs are slow-rate limited to reduce Electromagnetic Interference (EMI) concerns.

Pin Name	Pin Number	Type	Description
SVC~	1	Digital I/O	Service (active low)
IO0	2	Digital I/O	IO0 for I/O Objects
IO1	3	Digital I/O	IO1 for I/O Objects
IO2	4	Digital I/O	IO2 for I/O Objects
IO3	5	Digital I/O	IO3 for I/O Objects
VDD1V8	6	Power	1.8 V Power Input (from internal voltage regulator)
IO4	7	Digital I/O	IO4 for I/O Objects
VDD3V3	8	Power	3.3 V Power
IO5	9	Digital I/O	IO5 for I/O Objects
IO6	10	Digital I/O	IO6 for I/O Objects
IO7	11	Digital I/O	IO7 for I/O Objects
IO8	12	Digital I/O	IO8 for I/O Objects
IO9	13	Digital I/O	IO9 for I/O Objects
IO10	14	Digital I/O	IO10 for I/O Objects
IO11	15	Digital I/O	IO11 for I/O Objects
VDD1V8	16	Power	1.8 V Power Input (from internal voltage regulator)
TRST~	17	Digital Input	JTAG Test Reset (active low)
VDD3V3	18	Power	3.3 V Power
TCK	19	Digital Input	JTAG Test Clock
TMS	20	Digital Input	JTAG Test Mode Select
TDI	21	Digital Input	JTAG Test Data In
TDO	22	Digital Output	JTAG Test Data Out
XIN	23	Oscillator In	Crystal oscillator Input
XOUT	24	Oscillator Out	Crystal oscillator Output
VDDPLL	25	Power	1.8 V Power Input (from internal voltage regulator)
GNDPLL	26	Power	Ground
VOUT1V8	27	Power	1.8 V Power Output (of internal voltage regulator)
RST~	28	Digital I/O	Reset (active low)
VIN3V3	29	Power	3.3 V input to internal voltage regulator
VDD3V3	30	Power	3.3 V Power
AVDD3V3	31	Power	3.3 V Power

Pin Name	Pin Number	Type	Description
CP0	32	Communications	Single-Ended Mode: Receive serial data Special Purpose Mode: Receive serial data
AGND	33	Ground	Ground
CP1	34	Communications	Single-Ended Mode: Transmit serial data Special Purpose Mode: Transmit serial data
NC	35	N/A	Do Not Connect
GND	36	Ground	Ground
CP2	37	Communications	Single-Ended Mode: External transceiver enable Special Purpose Mode: Bit clock
CP3	38	Communications	Do Not Connect
CP4	39	Communications	Single-Ended Mode: Collision detect Special Purpose Mode: Frame clock
CS0~	40	Digital I/O	SPI slave select 0 (CS0~, active low) (for external memory connection only)
VDD3V3	41	Power	3.3 V Power
VDD3V3	42	Power	3.3 V Power
SDA_CS1~	43	Digital I/O	I <sup>2</sup> C: serial data (SDA) SPI: slave select 1 (CS1~, active low) (for external memory connection only)
VDD1V8	44	Power	1.8 V Power Input (from internal voltage regulator)
SCL	45	Digital I/O	I <sup>2</sup> C: serial clock (SCL) (for external memory connection only)
MISO	46	Digital I/O	SPI master input, slave output (MISO) (for external memory connection only)
SCK	47	Digital I/O	SPI serial clock (SCK) (for external memory connection only)

Pin Name	Pin Number	Type	Description
MOSI	48	Digital I/O	SPI master output, slave input (MOSI) (for external memory connection only)
PAD	49	Ground Pad	Ground

Table 3: Neuron 5000 Processor Pin Description

## Electrical Characteristics

### Neuron 5000 Processor Operating Conditions

Parameter <sup>1</sup>	Description	Minimum	Typical	Maximum
$V_{DD3}$	Supply voltage	3.00 V	3.3 V	3.60 V
$V_{LVI}$	Low-voltage indicator trip point	2.70 V		2.96 V
$T_A$	Ambient temperature	-40° C		+85° C
$f_{XIN}$	XIN clock frequency <sup>2</sup>	-	10,000 MHz	-
$I_{DD3}$	Current consumption <sup>3</sup>			
	5MHz		9 mA	15 mA
	10MHz		9 mA	15 mA
	20MHz		15 mA	23 mA
	40MHz		23 mA	33 mA
	80MHz		38 mA	52 mA

Table 4: Neuron 5000 Processor Operating Conditions

### Notes

- All parameters assume nominal supply voltage ( $V_{DD3} = 3.3 V \pm 0.3 V$ ) and operating temperature ( $T_A$  between -40°C and +85°C), unless otherwise noted.
- See Clock Requirements in the Series 5000 Chip Data Book for more detailed information about the XIN clock frequency.
- Assumes no load on digital I/O pins, and that the I/O lines are not switching.

## Digital Pin Characteristics

The digital I/O pins (IO0-IO11) have LVTTTL-level inputs. Pins IO0-IO7 also have low-level-detect latches. The RST- and SVC- pins have internal pull-ups, and the RST- pin has hysteresis.

Table 5 below lists the characteristics of the digital I/O pins, which include IO0-IO11, CP0-CP4 and the other digital pins listed in Table 3.

Parameter <sup>1</sup>	Description	Minimum	Typical	Maximum
$V_{OH}$	Output drive high at $I_{OH} = 8 \text{ mA}$	2.4 V		$V_{DD3}$
$V_{OL}$	Output drive low at $I_{OL} = 8 \text{ mA}$	GND		0.4 V
$V_{IH}$	Input high level	2.0 V		5.5 V
$V_{IL}$	Input low level	GND		0.8 V
$V_{HYS}$	Input hysteresis for RST- pin		300 mV	
$I_{IN}$	Input leakage current	-		10 $\mu\text{A}$
$R_{PU}$	Pullup resistance <sup>2</sup>	13 k $\Omega$		23 k $\Omega$
$I_{PU}$	Pullup current when pin at 0 V <sup>2</sup>	130 $\mu\text{A}$		275 $\mu\text{A}$

Table 5: Neuron 5000 Processor Digital Pin Characteristics

### Notes

- All parameters assume nominal supply voltage ( $V_{DD3} = 3.3 V \pm 0.3 V$ ) and operating temperature ( $T_A$  between -40°C and +85°C), unless otherwise noted.
- Applies to RST- and SVC- pins only.

## Recommended Neuron 5000 Processor Pad Layout

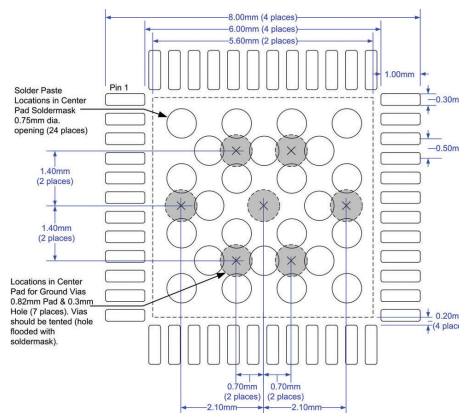
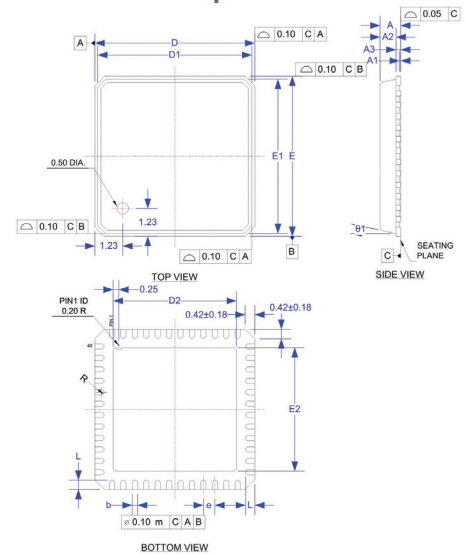

Figure 8: Neuron 5000 Processor Pad Layout

## Neuron 5000 Processor IC Mechanical Specification



\* CONTROLLING DIMENSION : MM

SYMBOL	MILLIMETER			INCH		
	MIN.	NOM.	MAX.	MIN.	NOM.	MAX.
A	---	---	0.90	---	---	0.035
A1	0.00	0.01	0.05	0.00	0.0004	0.002
A2	---	0.65	0.70	---	0.026	0.028
A3	0.20 REF.		0.008 REF.			
b	0.18	0.23	0.30	0.007	0.009	0.012
D	7.00 bsc		0.276 bsc			
D1	6.75 bsc		0.266 bsc			
D2	5.20	5.40	5.60	0.205	0.213	0.220
E	7.00 bsc		0.276 bsc			
E1	6.75 bsc		0.266 bsc			
E2	5.20	5.40	5.60	0.205	0.213	0.220
L	0.30	0.40	0.50	0.012	0.016	0.020
e	0.50 bsc		0.020 bsc			
$\theta 1$	0°	---	12°	0°	---	12°
R	0.09	---	---	0.004	---	---
TOLERANCES OF FORM AND POSITION						
aaa	0.10		0.004			
bbb	0.10		0.004			
ccc	0.05		0.002			

Figure 9: Neuron 5000 Processor IC Mechanical Specifications

### Notes

- All dimensions are in millimeters.
- Dimensions and tolerances conform to ASME Y14.5M.-1994.
- Package warpage max. 0.08 mm.
- Package corners unless otherwise specified are  $R0.175 \pm 0.025 \text{ mm}$ .

## Neuron 5000 Tape and Reel

Devices are uniformly loaded in the carrier tape such that the device pin one is oriented in quadrant 1 toward the side of the tape having round sprocket holes. Figure 10 illustrates the pin-one location.

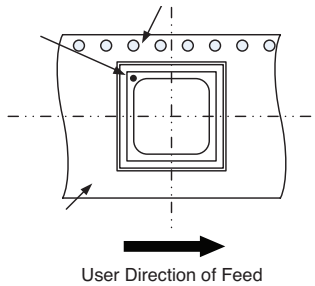

Figure 10: Neuron 5000 Pin One Orientation

Figure 11 shows the outline dimensions of the carrier tape.

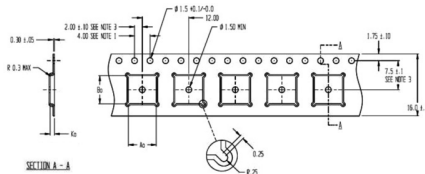

Figure 11: Carrier Tape Outline Drawing

$A_o = B_o = 7.25$

$K_o = 1.10$

Notes

1. All dimensions are in millimeters.
2. Tolerances unless noted: 1PL + 0.2, 2PL + 0.1
3. 10 Sprocket hole pitch cumulative tolerance +0.2
4. Camber in compliance with EIA 481.
5. Pocket position relative to sprocket hole measured as true position of pocket, not pocket hole.

For more information, refer to EIA-481-B, **Taping of Surface Mount Components for Automatic Placement.**

Figure 12: Neuron 5000 10" Reel and Hub Drawing

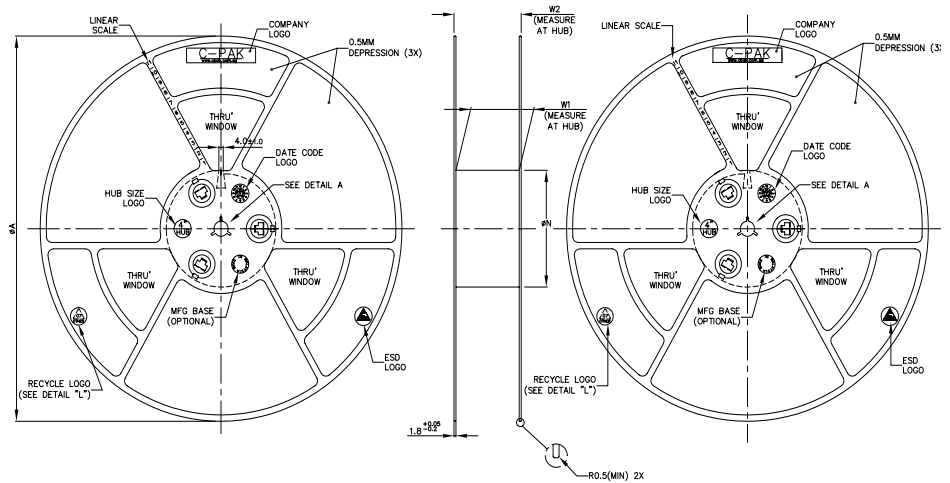

PRODUCT SPECIFICATIONS				
TAPE WIDTH	$\phi A$ (MAX)	$\phi N$ (MIN)	$W1 \pm 2.0$ -6.0	$W2$ (MAX)
8MM	330	100	8.4	14.4
12MM	330	100	12.4	18.4
16MM	330	100	16.4	22.4
24MM	330	100	24.4	30.4
32MM	330	100	32.4	38.4
44MM	330	100	44.4	50.4
56MM	330	100	56.4	62.4

SURFACE RESISTIVITY			
LEGEND	SR RANGE	TYPE	COLOUR
A	BELOW $10^{12}$	ANTISTATIC	ALL TYPES
B	$10^6$ TO $10^{11}$	STATIC DISSIPATIVE	BLACK ONLY
C	$10^5$ AND BELOW $10^5$	CONDUCTIVE (GENERIC)	BLACK ONLY
C	$10^5$ TO $10^9$	CONDUCTIVE (CUSTOM)	BLACK ONLY

Figure 12 shows the Neuron 5000 Series 13" Reel Drawing and Specification.

Figure 13 shows the 5000 Series 7" Reel Drawing and Specification.

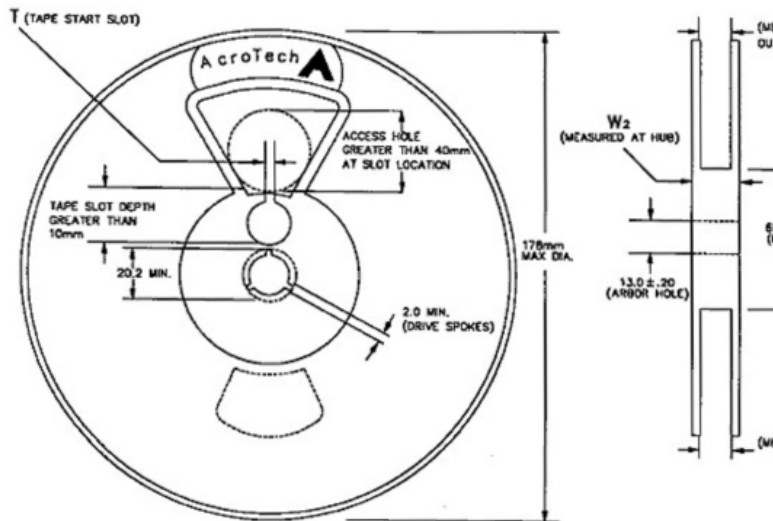

TAPE SIZE	T	W <sub>1</sub>	W <sub>2</sub>	W <sub>3</sub>
8mm	4.0 ± 0.25	+1.5 8.4-0.0	14.4 MAX.	7.9 MIN. 10.9 MAX.
12mm	5.0 ± 0.50	+2.0 12.4-0.0	18.4 MAX.	11.9 MIN. 15.4 MAX.
16mm	7.0 ± 0.50	+2.0 16.4-0.0	22.4 MAX.	15.9 MIN. 19.4 MAX.
24mm	11.0 ± 0.50	+2.0 24.4-0.0	30.4 MAX.	23.9 MIN. 27.4 MAX.
32mm	11.0 ± 0.50	+2.0 32.4-0.0	38.4 MAX.	31.9 MIN. 35.4 MAX.

Figure 13: Neuron 5000 7" Reel and Hub Drawing

## Specifications

### RoHS-Compliant

The Neuron 5000 Processor is compliant with the European Directive 2002/95/EC on the restriction of the use of certain hazardous substances (RoHS) in electrical and electronic equipment.

### EMC

Specifications depend on the network transceiver used with the Neuron 5000 Processor.

### Transmission Speed

Depends on network transceiver: 78 kbit/s for TP/FT-10 channel; 1250 kbit/s for TP/XF-1250 channel. (See EIA-485 channel specification for transmission speed characteristics.)

### Operating Temperature

-40 to 85°C

### Reflow Soldering Temperature Profile

Refer to Joint Industry Standard document *IPC/JEDEC J-STD-020D.1 (March 2008)*.

### Peak Reflow Soldering Temperature

## Ordering Information

Neuron 5000 Processor 14305R-2000  
14305R-500