

NPN SURFACE MOUNT DARLINGTON TRANSISTOR
Features

- 40V Darlington Transistor
- Epitaxial Planar Die Construction
- Ideal for Low Power Amplification and Switching
- High Current Gain
- Ultra-Small Surface Mount Package
- **Lead Free, RoHS Compliant (Note 1)**
- **Halogen and Antimony Free "Green" Device (Note 2)**

Mechanical Data

- Case: SOT-323
- Case Material: Molded Plastic, "Green" Molding Compound, Note 4. UL Flammability Classification Rating 94V-0
- Moisture Sensitivity: Level 1 per J-STD-020
- Terminals: Solderable per MIL-STD-202, Method 208
- Lead Free Plating (Matte Tin Finish annealed over Alloy 42 leadframe).
- Weight: 0.006 grams (approximate)



Top View

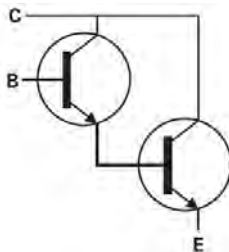

Device symbol

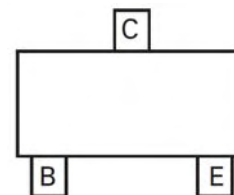

Pin-out Top view

Ordering Information (Note 3)

Product	Marking	Reel size (inches)	Tape width (mm)	Quantity per reel
MMST6427-7-F	K1D	7	8	3,000

- Notes:
1. No purposefully added lead.
 2. Diodes Inc.'s "Green" Policy can be found on our website at <http://www.diodes.com>
 3. For Packaging Details, go to our website at <http://www.diodes.com>.

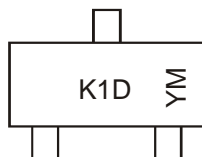
Marking Information

K1D= Product Type Marking Code
 YM = Date Code Marking
 Y = Year ex: X = 2010
 M = Month ex: 9 = September

Date Code Key

Year	2010		2011		2012		2013		2014		2015	
Code	X		Y		Z		A		B		C	
Month	Jan	Feb	Mar	Apr	May	Jun	Jul	Aug	Sep	Oct	Nov	Dec
Code	1	2	3	4	5	6	7	8	9	O	N	D

Maximum Ratings @ $T_A = 25^\circ\text{C}$ unless otherwise specified

Characteristic	Symbol	Value	Unit
Collector-Base Voltage	V_{CB0}	40	V
Collector-Emitter Voltage	V_{CEO}	40	V
Emitter-Base Voltage	V_{EBO}	12	V
Collector Current - Continuous (Note 4)	I_C	500	mA
Power Dissipation (Note 4)	P_d	200	mW
Thermal Resistance, Junction to Ambient (Note 4)	$R_{\theta JA}$	625	$^\circ\text{C/W}$
Operating and Storage Temperature Range	T_j, T_{STG}	-55 to +150	$^\circ\text{C}$

Electrical Characteristics @ $T_A = 25^\circ\text{C}$ unless otherwise specified

Characteristic	Symbol	Min	Max	Unit	Test Condition
OFF CHARACTERISTICS (Note 5)					
Collector-Base Breakdown Voltage	BV_{CB0}	40	—	V	$I_C = 100\mu\text{A}, I_E = 0$
Collector-Emitter Breakdown Voltage	BV_{CEO}	40	—	V	$I_C = 10\text{mA}, I_B = 0$
Emitter-Base Breakdown Voltage	BV_{EBO}	12	—	V	$I_E = 10\mu\text{A}, I_C = 0$
Collector Cutoff Current	I_{CB0}	—	50	nA	$V_{CB} = 30\text{V}, I_E = 0$
Collector Cutoff Current	I_{CEO}	—	1.0	μA	$V_{CE} = 25\text{V}, I_B = 0$
Emitter Cutoff Current	I_{EBO}	—	50	nA	$V_{EB} = 10\text{V}, I_C = 0$
ON CHARACTERISTICS (Note 5)					
DC Current Gain	h_{FE}	10,000 20,000 14,000	100,000 200,000 140,000	—	$I_C = 10\text{mA}, V_{CE} = 5.0\text{V}$ $I_C = 100\text{mA}, V_{CE} = 5.0\text{V}$ $I_C = 500\text{mA}, V_{CE} = 5.0\text{V}$
Collector-Emitter Saturation Voltage	$V_{CE(sat)}$	—	1.2 1.5	V	$I_C = 50\text{mA}, I_B = 0.5\text{mA}$ $I_C = 500\text{mA}, I_B = 0.5\text{mA}$
Base-Emitter Saturation Voltage	$V_{BE(sat)}$	—	2.0	V	$I_C = 500\text{mA}, I_B = 0.5\text{mA}$
Base-Emitter On Voltage	$V_{BE(on)}$	—	1.75	V	$I_C = 50\text{mA}, V_{CE} = 5.0\text{V}$
SMALL SIGNAL CHARACTERISTICS					
Output Capacitance	C_{obo}	8.0 Typical		pF	$V_{CB} = 10\text{V}, f = 1.0\text{MHz}, I_E = 0$
Input Capacitance	C_{ibo}	15 Typical		pF	$V_{EB} = 0.5\text{V}, f = 1.0\text{MHz}, I_C = 0$

- Notes: 4. Device mounted on 25mm x 22 mm x 1.6mm FR4 PCB, 1oz copper, singled sided
5. Short duration pulse test used to minimize self-heating effect.

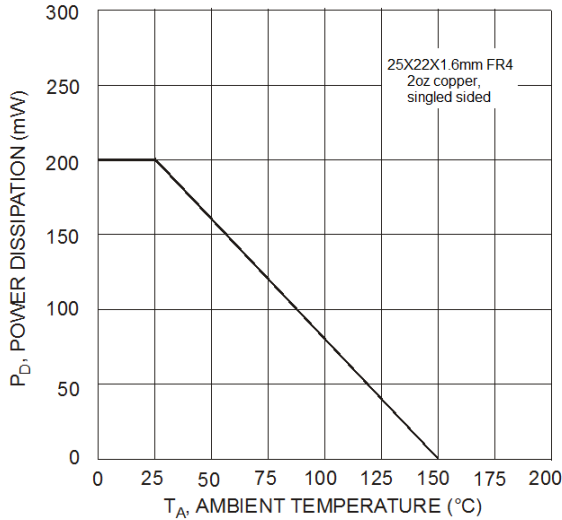

Fig. 1, Max Power Dissipation vs. Ambient Temperature

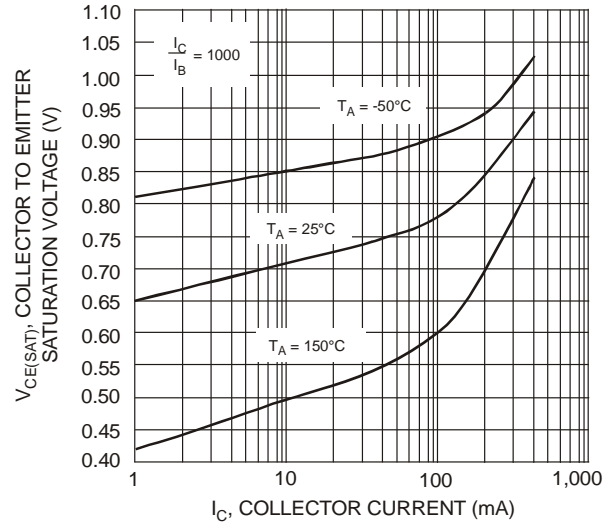

Fig. 2, Collector Emitter Saturation Voltage vs. Collector Current

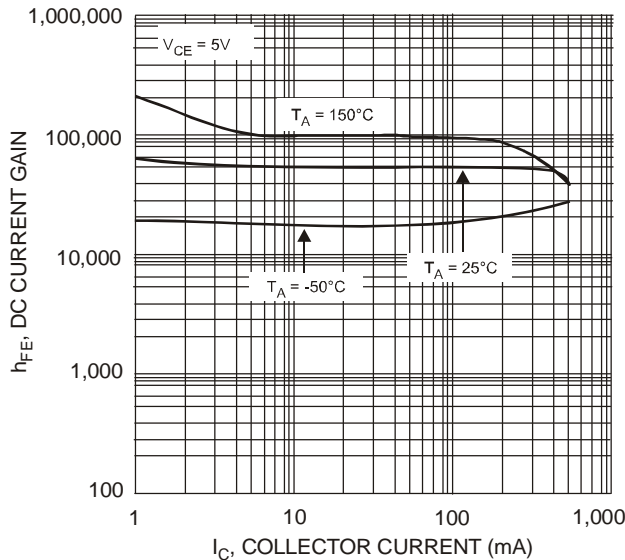

Fig. 3, DC Current Gain vs. Collector Current

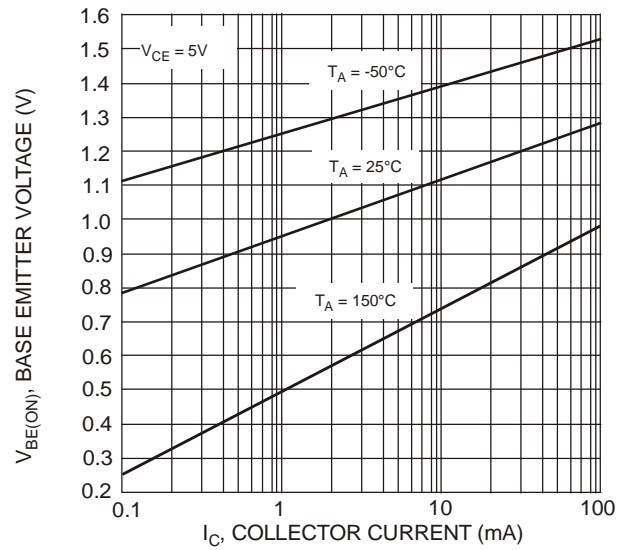

Fig. 4, Base Emitter Voltage vs. Collector Current

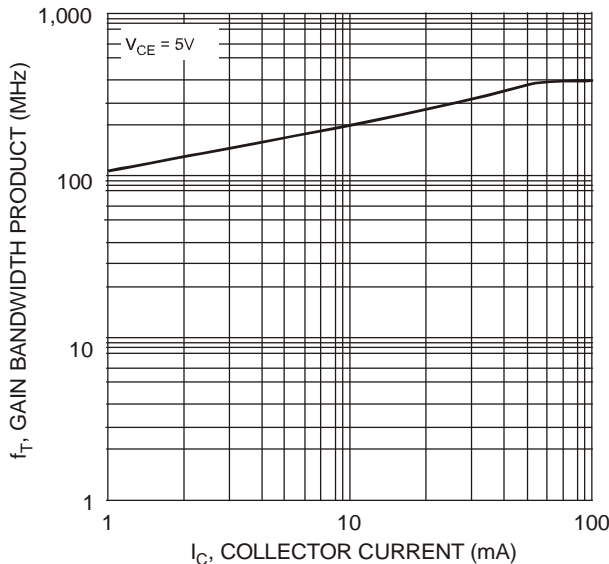
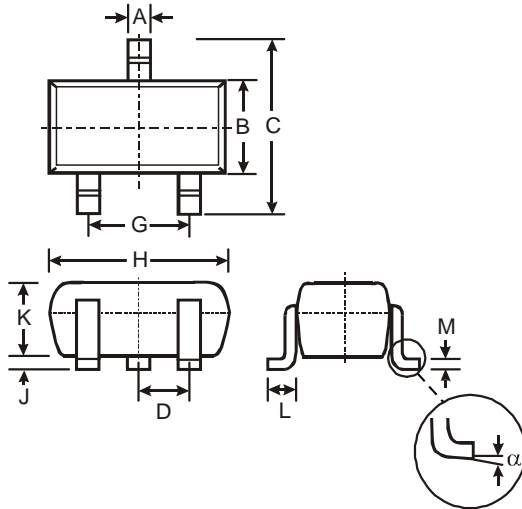

Fig. 5, Gain Bandwidth Product vs. Collector Current

Package Outline Dimensions



SOT323			
Dim	Min	Max	Typ
A	0.25	0.40	0.30
B	1.15	1.35	1.30
C	2.00	2.20	2.10
D	-	-	0.65
G	1.20	1.40	1.30
H	1.80	2.20	2.15
J	0.0	0.10	0.05
K	0.90	1.00	1.00
L	0.25	0.40	0.30
M	0.10	0.18	0.11
α	0°	8°	-

All Dimensions in mm

Suggested Pad Layout

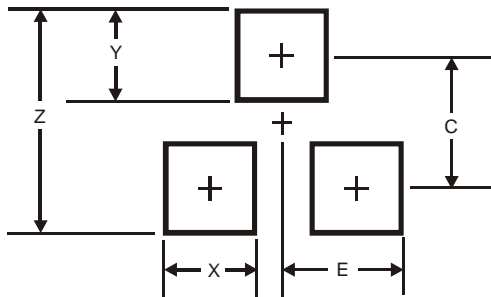

Dimensions	Value (in mm)
Z	2.8
X	0.7
Y	0.9
C	1.9
E	1.0

IMPORTANT NOTICE

DIODES INCORPORATED MAKES NO WARRANTY OF ANY KIND, EXPRESS OR IMPLIED, WITH REGARDS TO THIS DOCUMENT, INCLUDING, BUT NOT LIMITED TO, THE IMPLIED WARRANTIES OF MERCHANTABILITY AND FITNESS FOR A PARTICULAR PURPOSE (AND THEIR EQUIVALENTS UNDER THE LAWS OF ANY JURISDICTION).

Diodes Incorporated and its subsidiaries reserve the right to make modifications, enhancements, improvements, corrections or other changes without further notice to this document and any product described herein. Diodes Incorporated does not assume any liability arising out of the application or use of this document or any product described herein; neither does Diodes Incorporated convey any license under its patent or trademark rights, nor the rights of others. Any Customer or user of this document or products described herein in such applications shall assume all risks of such use and will agree to hold Diodes Incorporated and all the companies whose products are represented on Diodes Incorporated website, harmless against all damages.

Diodes Incorporated does not warrant or accept any liability whatsoever in respect of any products purchased through unauthorized sales channel. Should Customers purchase or use Diodes Incorporated products for any unintended or unauthorized application, Customers shall indemnify and hold Diodes Incorporated and its representatives harmless against all claims, damages, expenses, and attorney fees arising out of, directly or indirectly, any claim of personal injury or death associated with such unintended or unauthorized application.

Products described herein may be covered by one or more United States, international or foreign patents pending. Product names and markings noted herein may also be covered by one or more United States, international or foreign trademarks.

LIFE SUPPORT

Diodes Incorporated products are specifically not authorized for use as critical components in life support devices or systems without the express written approval of the Chief Executive Officer of Diodes Incorporated. As used herein:

A. Life support devices or systems are devices or systems which:

1. are intended to implant into the body, or
2. support or sustain life and whose failure to perform when properly used in accordance with instructions for use provided in the labeling can be reasonably expected to result in significant injury to the user.

B. A critical component is any component in a life support device or system whose failure to perform can be reasonably expected to cause the failure of the life support device or to affect its safety or effectiveness.

Customers represent that they have all necessary expertise in the safety and regulatory ramifications of their life support devices or systems, and acknowledge and agree that they are solely responsible for all legal, regulatory and safety-related requirements concerning their products and any use of Diodes Incorporated products in such safety-critical, life support devices or systems, notwithstanding any devices- or systems-related information or support that may be provided by Diodes Incorporated. Further, Customers must fully indemnify Diodes Incorporated and its representatives against any damages arising out of the use of Diodes Incorporated products in such safety-critical, life support devices or systems.

Copyright © 2011, Diodes Incorporated

www.diodes.com